

# Tahoe

PONTOON BOATS



2010

# SUPERIOR CONSTRUCTION

## LUXURY AND STRENGTH.

Our total commitment to making the finest pontoon boats in the world has brought you the exciting Tahoe Pontoons. These luxurious boats are a beautiful composition of the finest elements known to pontoon boating, along with over 30 years of pontoon boat manufacturing experience. The finest construction, the most luxurious designs and the largest group of unique standard features create a distinctly different and clearly superior pontoon boat that will exceed your expectations.

Tahoe is a vertically integrated builder. We manufacture the pontoons, framing, furniture, covers and more right in our own production facility using the latest computer driven equipment such as our Water Jet cutter, Gerber fabric cutter, Tiger saws, and the latest in welding technology. As a result we are able to achieve and control the highest degree of quality.

Our number one investment, however, is our people. Tahoe's team of highly experienced welders, furniture makers and

assemblers descend from generations of Midwestern craftsmen that have been instrumental in the building of America. Our headquarters based customer service people will make sure your experience is exceptional.

Tahoe is rated as having one of the lowest incidents of warranty claims in the industry and has also won the 2008 and 2009 NMMA CSI Award for outstanding customer service.

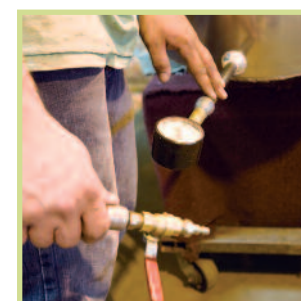
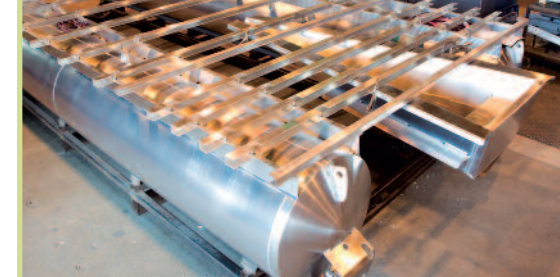
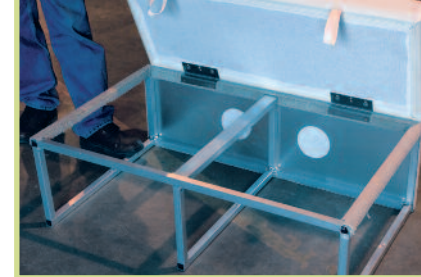

Our commitment to customer satisfaction and our superior construction gives us the confidence to place a 5 year bow to stern limited warranty on your boat! PLUS a lifetime limited warranty on the pontoon structure, seat frames and PTP decking! See your dealer for details!

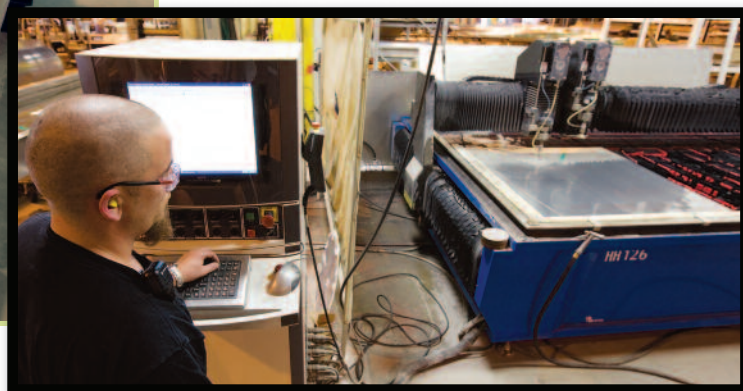

## TAHOE PONTOONS OFFERS THESE EXCLUSIVE HEAVY DUTY CONSTRUCTION FEATURES



- Tahoe's exclusive MATRIX 50 heavy duty 50 gauge marine seat covering with a 24% substructure is tested strongest against tears, punctures, and stains.
- New Herringbone multi-directional stretch backing promotes quicker recovery.
- Greater stitch strength.

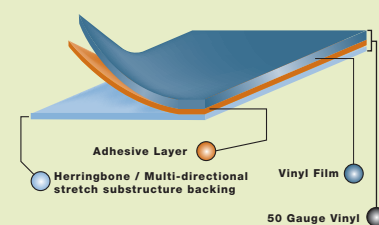

**Exclusive! Aluminum seat frames and kick panels**  
Clearly superior. Lifetime warranty. Aluminum seat frames are stronger, have extra large compartments for

maximum storage capacity and have "Flo thru™" ventilation from the outside. "Flo thru™" allows your equipment to dry out, even while the cover is on and keeps the entire compartment drier so mildew or fungus is less likely to develop. Aluminum frames won't crack or hold water like plastic, either!

**Heavy duty nose cone with our industry-first integrated nose cone splash fins!**  
The absolute strongest in the industry.

The .100" thickness and one-piece construction makes it virtually impossible to break off a splash fin. The double wrapped leading edge provides maximum impact protection.

**Stronger! Double full pontoon connectors**  
Most models feature full riser pontoon connections inside and outside. Unlike our competitor's "small but skirted" riser connectors. Full risers provide continuous strength along the entire pontoon.

**Exclusive! Classic Series side keel protection**  
Special welded keels protect against damage from side impact. They also provide better performance as they limit the flow of water around the pontoon.

**Interior drain**  
Tahoe now exclusively has a drain in the corner of the rear bench where water that would collect from rain during storage is expelled through a drain channel and off the boat. This

significantly reduces the potential for stains that develop in the corners over time.

**Double vented gas fill**  
Only Tahoe has solved the issue of fuel fill splash back and slowness. Tahoe's exclusive double fuel vent allows pressure to escape so you can fill quickly with almost no splash back.

**Reflective safety striping**  
Tahoe adds an additional level of night safety with striping that can be seen from a distance when exposed to light.

**Industry's strongest double bolted motor pod assembly**  
.190" thickness with integrated splash fins. 2" thick aluminum sheathed transom is fully welded. The entire pod is double bolted with at least 16 3/8" bolts and supported by more heavy-duty "C" channels crossbeams than any other pontoon boat.

**Superior quality pontoon tube**  
.090" thickness H5052 marine aluminum alloy. Multi-baffled near each weld for

maximum strength and air lock. Hand-welded to rigid standards.

**The best crossbeam and deck construction**  
Tahoe "Classic" Series pontoon boats feature the latest in heavy-duty hull construction. 3" high, extreme thickness "C" channel crossbeams are bolted to the full riser with heavy-duty stainless bolts, nuts, and washers. Then 3/4", pressure injected, lifetime guaranteed flooring is bolted to the crossbeams using superior grade

stainless steel bolts secured permanently with stainless nylock lock nuts and washers.

**Strongest bow eye**  
Our standard equipment stainless bow eye is connected across three crossbeams with a 1/4" aluminum reinforcement strap. Excellent strength for haul-out.

**Wall joints**  
Wall joints welded on all four sides for extra strength.

# Tahoe

PONTOON BOATS

## STANDARD FEATURES

### Admiral Fiberglass Entertainment Helm Including:

- Faux Corian countertop with integrated sink, sink cover, electric faucet, and two gallon water reservoir
- Electric hidden entertainment bar with wine racks, wine glasses, stainless cup holders that raises and lowers at the touch of a button
- Refrigerator – DC electric stainless steel with slide out top loading cooling compartment
- Stainless steel easy slide drawer system with friction lock
- Level 5 dash package – automotive style dash with woodgrain panels, lighted stainless toggle switches, and windshield
- Lighted cup holder
- Full gauge panel featuring black sterling tachometer, voltmeter, and fuel gauge
- MP3 player storage bin with smoked glass cover and plug
- Surface storage trays for cell phone and other personal items
- Baystar hydraulic easy to turn tilt steering
- Woodgrain steering wheel with brilliant aluminum non-directional spokes

### Electronics

- Garmin full color GPS with built in inland maps, fishfinder, water temp, depth gauge, speedometer
- Jensen MSR2107 high power waterproof stereo with 1 GB storage and memory stick input. Includes four Marine Audio high power speakers and stainless logo speaker covers
- Two 12 volt power points – helm and bow
- Dual battery system with auto twin charge and start protect

### Lighting

- Exclusive dual battery box under sundeck for easy battery access
- Docking lights built into front walls in heavy duty reinforced housing
- Stainless amber floor mood lighting
- Engine compartment light
- Bimini top light
- Stainless courtesy light on side of Admiral's stand
- USCG navigation and stern lighting

### Furnishings

- Furnishings are created using Tahoe's exclusive MATRIX 50 heavy duty 50 gauge stain, tear and puncture resistant marine upholstery
- Upholstered aluminum seat frames with dry floor matting and flow through ventilation

- Plush sweeping radius designer furnishings
- Textured accent vinyl with gold trim
- Plush lounge arm – starboard bench
- Plush pillowed arm rests to port benches
- Exclusive Comfort-Plush™ high back reclining Admiral's chair with slide and swivel

### Styling

- Unique front and rear radius deck with simulated teak flooring
- Unique front and rear radius walls
- Rear entry gate with swim platform rear entry ladder
- External wall skins with 29" high 1 1/4" diameter .090" anodized railings
- Hidden wall seams
- Engraved interior door panels with net
- Stainless steel non-skid strips for doorways
- Upholstered decorative interior wall covering
- Hideaway flip down cup holders built into seat back
- Plush 28 oz. Islands designer carpet
- Three dimensional deluxe raised logos
- Superior stripe kit

### Convenience

- Convenience center with Corian style surface, paper towel holder, and storage
- Trash can built in

- Two exclusive stylish smoked glass tables with wine glass holders and stainless decorative cup holders
- Fire extinguisher
- Four eye straps to mount fenders
- Four stainless pop up cleats
- 36 gallon fuel capacity with SST gas cap and vent

### Canvas and Top

- 10' Bimini top with logo boot
- Six stainless steel easy to use twist lock Bimini quick connect
- Transport position support brackets for Bimini top
- Color matched full mooring cover with vented pole supports

### Construction

- 8 1/2" wide
- 25" diameter pontoons
- Double full riser connections
- Exclusive side protector keels
- Heavy duty 4" reinforced deck rail with black rubber bumper
- Heavy duty 3" C-channel crossbeams
- Bolted deck with stainless bolts and lock nuts
- Stainless steel corner castings all four corners
- Extra heavy duty motor pod double bolted with 3/8" SST bolts
- Gate latches with stainless steel insert and welded safety tab

## INTERIOR OPTIONS

### REAR ENTRY

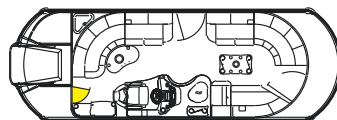

25'

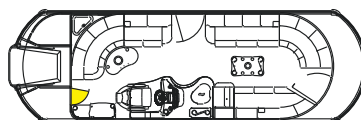

27'

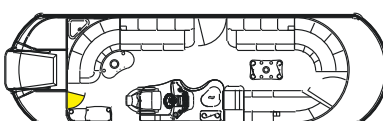

29'

### ELITE

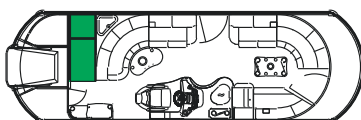

27'

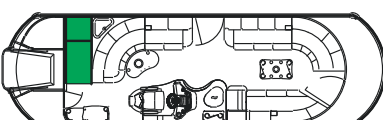

29'

## OPTIONS

### Deck Options

- Aluminum decking

### Flooring Options

- Vinyl flooring (n/a on aluminum deck)
- Snap-in carpet (upgrade to vinyl flooring also required)

### Captain's Chair Options

- Admiral's chair with flip up bolster
- High performance sport barrel chair with bolster

### Furniture Options

- Buckskin base vinyl (recommended only with colored wall skin)

- Luxury umbrella (Tan only) with exclusive stylish round smoked glass table with wine glass holders and stainless decorative cup holder

### Dash/Electronics Options

- Garmin 440S Coastal GPS (upgrade exchange)
- Premium sound system upgrade (six coaxial speakers, subwoofer, amp.)
- Battery dual selector switch

### Steering Options

- Electric power assist steering (requires Sea Star upgrade)
- Sea Star hydraulic high capacity steering

### Bimini and Hard Top Options

- Second Bimini top – factory pre-installed only
- Standard walk-on sun roof (8' or 10') with ladder (ladder at front of roof except 8' on Elite models) available factory installed only

- 12' aluminum hard top (factory installed only)

### Performance Options

- Waveglider™ high performance pontoons – see pages 14 and 15
- Sport Graphics Package – see page 16
- Aluminum waveshield

### Watersports Options

- Ski tow bar
- Waterski/wakeboard tower

### Camper Enclosure Options – Factory Pre-installed Only

- 1/2 camper enclosure
- Full camper enclosure
- 1/2 camper enclosure with bow cover

### Misc. Options

- Inflatable bow sleeper bed
- Stainless rail mounted gas grill
- Livewell under port bow bench
- Wash down kit with sprayer and pump
- Seat covers in place of, or in addition to, mooring cover
- Colored wall skins – Black, Blue, Burgundy, and Champagne – Includes chrome dock light housings and custom matched graphics
- Docklines retractable built in
- Inboard/Outboard (standard only as a Waveglider™ model) – see pages 16 and 17

## 2010 GRAND TAHOE CLASSIC

# Tahoe

## PONTOON BOATS

Grand Tahoe 29' Elite



Grand Tahoe 27' Elite

## GRAND TAHOE EXHIBITS QUALITY

Constructed using the industry's strongest pontoon hull as its foundation, Grand Tahoe is the most exquisite pontoon boat available today. Grand Tahoe exhibits the quality of all five items that are forged by craftsmen to create luxury and strength. The unique design features sweeping radial fore and aft walls and a radial deck that encompasses a fabulous, luxuriously appointed interior featuring designer furnishings and an almost endless list of standard features. It's simply the finest pontoon ever created.

Grand Tahoe 27' Elite

Grand Tahoe 25' RE

## STANDARD FEATURES

### Commander Fiberglass Helm Including:

- Level 5 dash package – automotive style dash with woodgrain panels, lighted stainless toggle switches and windshield
- Lighted cup holder
- Full gauge panel featuring black sterling tachometer, voltmeter, and fuel gauge
- MP3 player storage bin with smoked glass cover and plug
- Surface storage trays for cell phone and other personal items
- Baystar hydraulic easy to turn tilt steering
- Woodgrain steering wheel with brilliant aluminum non-directional spokes
- Smoked glass side door and storage with fuse panel

### Electronics

- Garmin full color GPS with built in inland maps, fishfinder water temp, depth gauge, speedometer

- Jensen MSR2107 high power waterproof stereo with 1 GB storage and memory stick input. Includes four Marine Audio high power speakers and stainless logo speaker covers
- Two 12 volt power points – helm and bow
- Exclusive Dual Battery box under sundeck for easy battery access

### Lighting

- Docking lights built into front walls in heavy duty reinforced housing
- Stainless amber floor mood lighting
- Engine compartment light
- Bimini top light
- Stainless courtesy light on side of Admiral's stand
- USCG navigation and stern lighting

### Furnishings

- Furnishings are created using exclusive MATRIX 50 marine upholstery

- Upholstered aluminum seat frames with dry floor matting and flow through ventilation
- Plush radius designer furnishings
- Textured accent vinyl with gold trim
- Plush deluxe lounge arms
- Exclusive Comfort-Plush™ high back reclining Admiral's chair with slide and swivel
- Portable cup holders

### Styling

- Front radius walls
- Rear entry gate with swim platform rear entry ladder
- External wall skins with 29" high 1 1/4" diameter .090" anodized railings
- Hidden wall seams
- Engraved interior door panels with net
- Stainless steel non-skid strips for doorways
- Plush 28 oz. Islands carpet
- Three dimensional deluxe raised logos
- Superior stripe kit

### Convenience

- Trash can built in
- Deluxe wine rack with ice carafe built in
- Exclusive stylish curved smoked glass table with wine glass holders and stainless decorative cup holders
- Fire extinguisher
- Four eye straps to mount fenders
- Four stainless pop up cleats
- 36 gallon fuel capacity with SST gas cap and vent

### Canvas and Top

- 10' Bimini top with logo boot
- Six stainless steel easy to use twist lock Bimini quick connect
- Transport position support brackets for Bimini top
- Color matched full mooring cover with vented pole supports

### Construction

- 8 1/2" wide
- 25" diameter pontoons
- Double full riser connections
- Exclusive side protector keels
- Heavy duty 4" reinforced deck rail with black rubber bumper
- Heavy duty 3" C-channel crossbeams
- Bolted deck with stainless bolts and lock nuts
- Stainless steel corner castings all four corners
- Extra heavy duty motor pod double bolted with 3/8" SST bolts
- Gate latches with stainless steel insert and welded safety tab

## INTERIOR OPTIONS

### REAR ENTRY

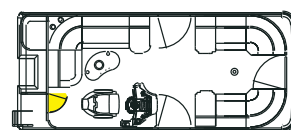

20'

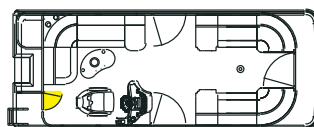

22'

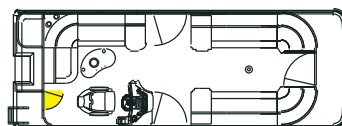

24'

### ELITE

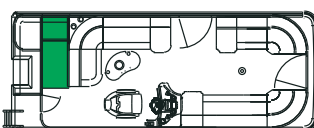

22'

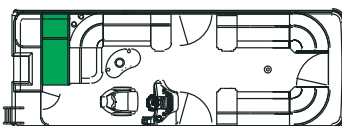

24'

## SPECIFICATIONS

Length	20'	22'	24'
Pontoon Diameter	25"	25"	25"
Width	8 1/2'	8 1/2'	8 1/2'
Dry Weight	1,800	2,050	2,250
Max Weight Cap.	2,130	2,260	2,600
Max Engine HP	115	125	150
Max # People	10	11	13
Max People Lbs.	1,380	1,600	1,850

## OPTIONS

### Deck Options

- Aluminum decking

### Flooring Options

- Vinyl flooring (n/a on aluminum deck)
- Snap-in carpet (upgrade to vinyl flooring also required)

### Captain's Chair Options

- Admiral's chair with flip up bolster
- Double wide recliner Admiral's chair
- High performance sport barrel chair with bolster

### Furniture Options

- Buckskin base vinyl (recommended only with colored wall skin)

### Luxury umbrella (Tan only)

- with exclusive stylish round smoked glass table with wine glass holders and stainless decorative cup holder

### Entertaining Options

- Refreshment center COMMANDER in place of lounge arm with sink, electric faucet, two gallon water reservoir, trash can liner, and stainless drawer with ice cube cooler
- Refreshment center CAPTAIN in place of lounge arm with sink, electric faucet, two gallon water reservoir, trash can liner, and smoked glass style door

### Convenience center with Corian style surface, paper towel holder, and storage

- Refrigerator – DC electric stainless steel with slide out top loading cooling compartment in special housing with Corian style surface
- Stainless gas grill

### Dash/Electronics Options

- Garmin 440S Coastal GPS (upgrade exchange)
- Premium sound system upgrade (six coaxial speakers, subwoofer, amp.)
- Dual battery system with auto twin charge and start protect
- Battery dual selector switch

### Steering Options

- Electric power assist steering (requires Sea Star upgrade)
- Sea Star hydraulic high capacity steering

### Bimini and Hard Top Options

- Second Bimini top – factory pre-installed only
- Standard walk-on sun roof (8' or 10') with ladder (ladder at front of roof except 8' on Elite models) available factory installed only
- 12' aluminum hard top (factory installed only)

### Performance Options

- Waveglider™ high performance pontoons – see pages 14 and 15
- Sport Graphics Package – see page 16
- Aluminum waveshield
- Ski tow bar
- Waterski/wakeboard tower

### Camper Enclosure Options – Factory Pre-installed Only

- 1/2 camper enclosure (Full camper enclosure (22' and up only)
- 1/2 camper enclosure with bow cover

### Misc. Options

- Inflatable bow sleeper bed
- Livewell under port bow bench
- Wash down kit with sprayer and pump
- Seat covers in place of, or in addition to, mooring cover
- Colored wall skins – Black, Blue, Burgundy, and Champagne – Includes chrome dock light housings and custom matched graphics
- Docklines retractable built in
- Front radius deck
- Inboard/Outboard (standard only as a Waveglider™ model) see pages 16 and 17

## 2010 SIERRA

# Tahoe

## PONTOON BOATS



Sierra 20' RE



Sierra 24' Elite

Some models shown with optional equipment.



## A LEGEND IN TOP OF THE LINE, LUXURY PONTOON BOATS.

Tahoe's Sierra is praised for its magnificent blend of form and function. The industry's strongest pontoon hull is the foundation for the modern radius styling and plush furnishings made with Tahoe's exclusive MATRIX 50 seat coverings. Tahoe's custom designed "Comfort-Plush™" reclining Admiral's chair, a Garmin color GPS and a classy wine rack are just a few of the other amenities.



Sierra 22' Elite

## STANDARD FEATURES

### Commander Fiberglass Helm Including:

- Level 5 dash package – automotive style dash with woodgrain panels, lighted stainless toggle switches and windshield
- Lighted cup holder
- Full gauge panel featuring black sterling tachometer, voltmeter, and fuel gauge
- MP3 player storage bin with smoked glass cover and plug
- Surface storage trays for cell phone and other personal items
- Baystar hydraulic easy to turn tilt steering
- Woodgrain steering wheel with brilliant aluminum non-directional spokes
- Smoked glass side door and storage with fuse panel

### Electronics

- Garmin full color GPS with built in inland maps, fishfinder water temp, depth gauge, speedometer

- Jensen MSR2107 high power waterproof stereo with 1 GB storage and memory stick input. Includes four Marine Audio high power speakers and stainless logo speaker covers
- Two 12 volt power points – helm and bow
- Exclusive dual battery box under sundeck for easy battery access

### Lighting

- Docking lights built into front walls in heavy duty reinforced housing
- Stainless amber floor mood lighting
- Engine compartment light
- Bimini top light
- Stainless courtesy light on side of Admiral's stand
- USCG navigation and stern lighting

### Furnishings

- Furnishings are created using exclusive MATRIX 50 marine upholstery

- Upholstered aluminum seat frames with dry floor matting and flow through ventilation
- Plush radius designer furnishings
- Textured accent vinyl with gold trim
- Plush deluxe lounge arms
- Exclusive Comfort-Plush™ high back reclining drivers Admiral's chair with slide and swivel
- Two bow mount Comfort-Plush™ low back reclining Commander's chairs with slide and swivel
- Exclusive stylish round smoked glass cocktail table with wine glass holders and stainless decorative cup holder
- Livewell under port bow bench
- Stainless steel rod holders and cup holders at bow
- Portable cup holders

### Styling

- Front radius walls
- Rear entry gate with swim platform rear entry ladder
- External wall skins with 29" high 1 1/4" diameter .090" anodized railings
- Hidden wall seams
- Engraved interior door panels with net
- Stainless steel non-skid strips for doorways
- Plush 28 oz. Islands carpet
- Three dimensional deluxe raised logos
- Superior stripe kit

- Refrigerator – DC electric stainless steel with slide out top loading cooling compartment in special housing with Corian style surface
- Stainless gas grill

### Dash/Electronics Options

- Garmin 440S Coastal GPS (upgrade exchange)
- Premium sound system upgrade (six coaxial speakers, subwoofer, amp.)
- Dual battery system with auto twin charge and start protect
- Battery dual selector switch

### Steering Options

- Electric power assist steering (requires Sea Star upgrade)

### Convenience

- Deluxe wine rack with ice carafe built in
- Exclusive stylish curved smoked glass table with wine glass holders and stainless decorative cup holders
- Fire extinguisher
- Four eye straps to mount fenders
- Four stainless pop up cleats
- 36 gallon fuel capacity with SST gas cap and vent

### Canvas and Top

- 10' Bimini top with logo boot
- Six stainless steel easy to use twist lock Bimini quick connect
- Transport position support brackets for Bimini top
- Color matched full mooring cover with vented pole supports

### Construction

- 8 1/2" wide
- 25" diameter pontoons
- Double full riser connections
- Exclusive side protector keels
- Heavy duty 4" reinforced deck rail with black rubber bumper
- Heavy duty 3" C-channel crossbeams
- Bolted deck with stainless bolts and lock nuts
- Stainless steel corner castings all four corners
- Extra heavy duty motor pod double bolted with 3/8" SST bolts

## INTERIOR OPTIONS

### SIERRA RC

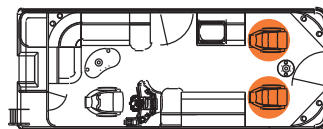

RE

22'

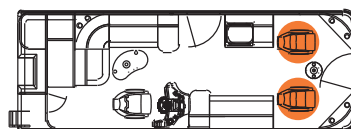

ELITE

24'

### SIERRA RCRF RE

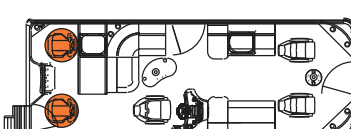

24'

- Gate latches with stainless steel insert and welded safety tab

- SPECIAL FEATURES – SIERRA RC
- Side privacy station (24' only)
- Trash can built in

- SPECIAL FEATURES – SIERRA RCRF
- Side privacy station

- SPECIAL FISHING FEATURES – SIERRA RCRF
- Two rear fishing stations with SST rod holder
- Rear rod box
- Tackle trays
- Large livewell over fuel tank

- Sea Star hydraulic high capacity steering
- Bimini and Hard Top Options
- Second Bimini top – factory pre-installed only
- 12" aluminum hard top (factory installed only)

- Performance Options
- Waveglider™ high performance pontoons – see pages 14 and 15
- Sport Graphics Package – see page 16
- Aluminum waveshield

- Watersports Options
- Ski tow bar
- Waterski/wakeboard tower

- Docklines retractable built in
- Front radius deck
- Inboard/Outboard (Standard only as a Waveglider™ model) – see pages 16 and 17

- SPECIAL OPTIONS – SIERRA RC ONLY
- Convenience center with Corian style surface, paper towel holder, and storage
- Standard walk-on sun roof (8' or 10') with ladder (ladder at front of roof except 8' on Elite models). Available factory installed only
- Waterski/wakeboard tower
- Bimini top for ski tower – SST frame

## 2010 SIERRA RC



Sierra RC 24' Elite



## IT JUST KEEPS GETTING BETTER.

Sierra RC is the whole package – excitement, luxury, fishing and comfort. The RC is equipped with plush Sierra furnishings and amenities mounted on the heavy duty classic series frame. Added are the beautiful, Tahoe exclusive, Comfort-Plush™ bow recliners. These reclining, swiveling chairs allow you to enjoy romantic relaxation, or use the nearby stainless steel rod holders and livewell to add comfortable fishing to your relaxation.



Sierra RC 22' RE



Some models shown with optional equipment.

## 2010 SIERRA RCRF



Some models shown with optional equipment.



Sierra RCRF 24'

## IT'S EASY TO BE ALL THINGS TO ALL PEOPLE.

Go one step beyond the luxurious Sierra RC model with this cruising, lounging and now fishing model. Who's on board? Fishermen? They will enjoy two fully equipped rear fishing stations with rod holders, livewell, and built in tackle trays. Loungers? They will revel in the plush recliner chairs at the bow. How about sunbathers? Let them just relax on the two lounge arm equipped bow benches. Everyone else will enjoy the plush interior and smooth ride.

Tahoe  
PONTON BOATS

## STANDARD FEATURES

### Entertainment Areas:

- Culinary center including: Refrigerator – DC electric stainless steel with slide out top loading cooling compartment in special housing with Corian style surface
- Stainless steel gas grill
- Commander refreshment center with sink, electric SST faucet, two gallon water reservoir, trash can liner, and stainless drawer
- Port side bow dinette with Commander low back recliners
- Umbrella with exclusive stylish round smoked glass table with wine glass holders and stainless decorative cup holder
- Large rear swim platform area with Plasteak non-skid flooring
- Rear bar and music center includes cup holders, remote stereo controls, 12 volt outlet, storage, and cube cooler
- Two rear Sandbar recliner chairs with footrest
- Exclusive stylish round smoked glass cocktail table with wine glass holders and stainless decorative cup holder
- Telescoping flag pole with American flag

### Performance

- Waveglider™ system – high performance pontoons
- Includes 25" triple pontoons and Tahoe's exclusive Waveglider™ – high performance lifting strakes and 42 gallon fuel tank for center pontoon
- Ski tow bar

### Commander Fiberglass Helm Including:

- Level 5 dash package – automotive style dash with woodgrain panels, lighted stainless toggle switches, and windshield
- Lighted cup holder
- Full gauge panel featuring black sterling tachometer, voltmeter, and fuel gauge
- MP3 player storage bin with smoked glass cover and plug
- Surface storage trays for cell phone and other personal items
- Sea Star hydraulic steering
- Woodgrain steering wheel with brilliant aluminum non-directional spokes
- Smoked glass side door and storage with fuse panel

### Electronics

- Garmin full color GPS with built in inland maps, fishfinder water temp, depth gauge, speedometer

## INTERIOR OPTIONS

### SIERRA SANDBAR

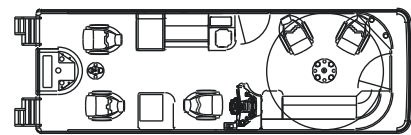

26'

### Lighting

- Docking lights built into front walls in heavy duty reinforced housing
- Stainless amber floor mood lighting
- Bimini top light
- Stainless courtesy light on side of Admiral's stand
- USCG navigation and stern lighting

### Furnishings

- Furnishings are created using exclusive MATRIX 50 marine upholstery
- Starboard radius bow bench
- Portside bench
- Port privacy station
- Textured accent vinyl with gold trim
- Plush deluxe lounge arms
- Exclusive Comfort-Plush™ high back reclining drivers Admiral's chair with slide and swivel
- Portable cup holders

### Styling

- Front radius walls
- External wall skins with 29" high 1 1/4" diameter .090" anodized railings
- Hidden wall seams
- Engraved interior door panels with net
- Stainless steel non-skid strips for doorways
- Plush 28 oz. Islands carpet
- Three dimensional deluxe raised logos
- Superior stripe kit

### Convenience

- Fire extinguisher
- Four eye straps to mount fenders
- Four stainless pop up cleats
- Dual battery system with auto twin charge and start protect
- One port and one starboard rear swim platform ladder

### Canvas and Top

- 10' Bimini top with logo boot
- Six stainless steel easy to use twist lock Bimini quick connect
- Transport position support brackets for Bimini top
- Color matched full mooring cover with vented pole supports

### Construction

- 8 1/2" wide
- Double full riser connections
- Exclusive side protector keels
- Heavy duty 4" reinforced deck rail with black rubber bumper
- Heavy duty 3" C-channel crossbeams
- Bolted deck with stainless bolts and lock nuts
- Stainless steel corner castings all four corners
- Extra heavy duty motor pod integrated into center pontoon
- Gate latches with stainless steel insert and welded safety tab

## 2010 SIERRA SANDBAR



Sierra Sandbar 26'



## RAISE YOUR FLAG!

Tahoe's Sandbar model is the ultimate party platform. Park at your favorite beach or sand bar and use the entire boat from end to end for swimming, partying, listening to tunes, lounging, and enjoying refreshments. When you're done with that, crank her up and charge across the water on the standard Waveglider™ high performance pontoons for skiing, tubing or just enjoying the warm breeze.



Sandbar 26'

Some models shown with optional equipment.

Tahoe  
PONTON BOATS

## OPTIONS

### Deck Options

- Aluminum decking

### Flooring Options

- Vinyl flooring (n/a on aluminum deck, n/a at rear area)
- Snap-in carpet (upgrade to vinyl flooring in main section also required)

### Captain's Chair Options

- Admiral's chair with flip up bolster
- Double wide recliner Admiral's chair
- High performance sport barrel chair with bolster

### Furniture Options

- Buckskin base vinyl (recommended only with colored wall skin)

### Dash/Electronics Options

- Garmin 440S Coastal GPS (upgrade exchange)
- Premium sound system upgrade (six coaxial speakers, subwoofer, amp.)
- Battery dual selector switch

### Steering Options

- Electric power assist steering

### Bimini and Hard Top Options

- Second Bimini top – factory pre-installed only

- Standard walk-on sun roof (8' or 10') with ladder (ladder at front of roof) available factory installed only
- 12" aluminum hard top (factory installed only)

### Performance Options

- 27" center pontoon upgrade
- Sport Graphics Package – see page 16
- Rough Water Package
- Aluminum waveshield

### Watersports Options

- Waterski/wakeboard tower
- Ski storage in center pontoon

### Camper Enclosure Options – Factory Pre-installed Only

- 1/2 camper enclosure
- Full camper enclosure

- 1/2 camper enclosure with bow cover

### Misc. Options

- Inflatable bow sleeper bed
- Livewell under port bow bench
- Wash down kit with sprayer and pump
- Seat covers in place of, or in addition to, mooring cover
- Colored wall skins – Black, Blue, Burgundy, and Champagne – Includes chrome dock light housings and custom matched graphics
- Docklines retractable built in
- Front radius deck Inboard/Outboard – see pages 16 and 17

## SPECIFICATIONS

Pontoon Length	26'
Pontoon Diameter	25"
Deck Width	8.5'
Weight with Furniture Lbs.	3,125
Max. Wt. Capacity Lbs.	3,200
Max Engine	250
Max. No. Persons	17
Or Max. Persons Lbs.	2,400

## STANDARD FEATURES

### Funship Special Equipment

- Deluxe 10' walk-on sun roof with rear ladder, Waterpark™ slide with waterfall water pump, decorative walls, king size upper deck lounge with backs and cushions, upper deck entertainment center with remote, stereo controls, two speakers, and storage
- Convenience center starboard rear with Corian style surface, paper towel holder, and storage

### Performance

- Waveglider™ high performance pontoons – includes 25' triple pontoons and Tahoe's exclusive Waveglider™ – high performance lifting strakes and 42 gallon fuel tank for center pontoon
- Ski tow bar

### Commander Fiberglass Helm Including:

- Level 5 dash package – automotive style dash with woodgrain panels, lighted stainless toggle switches and windshield
- Lighted cup holder

- Full gauge panel featuring black sterling tachometer, voltmeter, and fuel gauge
- MP3 player storage bin with smoked glass cover and plug
- Surface storage trays for cell phone and other personal items
- Sea Star hydraulic easy to turn tilt steering
- Woodgrain steering wheel with brilliant aluminum non-directional spokes
- Smoked glass side door and storage with fuse panel

### Electronics

- Garmin full color GPS with built in inland maps, fishfinder water temp, depth gauge, speedometer
- Jensen MSR2107 high power waterproof stereo with 1 GB storage and memory stick input. Includes four Marine Audio high power speakers and stainless logo speaker covers
- Two 12 volt power points – helm and bow
- Dual battery system with auto twin charge and start protect

- Exclusive dual battery box under sundeck for easy battery access

### Lighting

- Docking lights built into front walls in heavy duty reinforced housing
- Stainless amber floor mood lighting
- Engine compartment light
- Bimini top light
- Stainless courtesy light on side of Admiral's stand
- USCG navigation and stern lighting

### Furnishings

- Furnishings are created using exclusive MATRIX 50 marine upholstery
- Upholstered aluminum seat frames with dry floor matting and flow through ventilation
- Plush radius designer furnishings
- Textured accent vinyl with gold trim
- Plush deluxe lounge arms
- Exclusive Comfort-Plush™ high back reclining Admiral's chair with slide and swivel
- Portable cup holders

### Styling

- Front radius walls
- Rear entry gate with swim platform rear entry ladder

## INTERIOR OPTIONS

### SIERRA FUNSHIP

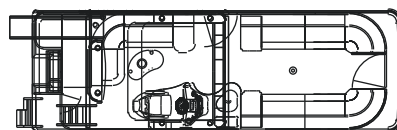

Drawing shows optional Admiral's helm.

- External wall skins with 29" high 1 1/4" diameter .090" anodized railings
- Hidden wall seams
- Engraved interior door panels with net
- Stainless steel non-skid strips for doorways
- Plush 28 oz. Islands carpet
- Three dimensional deluxe raised logos
- Superior stripe kit

- Trash can built in
- Deluxe wine rack with ice carafe built in
- Exclusive stylish curved smoked glass table with wine glass holders and stainless decorative cup holders
- Fire extinguisher
- Four eye straps to mount fenders
- Four stainless pop up cleats

### Canvas

- Color matched full mooring cover with vented pole supports

### Construction

- 8 1/2" wide
- Double full riser connections
- Exclusive side protector keels
- Heavy duty 4" reinforced deck rail with black rubber bumper
- Heavy duty 3" C-channel crossbeams
- Bolted deck with stainless bolts and lock nuts
- Stainless steel corner castings all four corners
- Gate latches with stainless steel insert and welded safety tab

## OPTIONS

### Deck Options

- Aluminum decking

### Flooring Options

- Vinyl flooring (n/a on aluminum deck)
- Snap-in carpet (upgrade to vinyl flooring also required)

### Captain's Chair Options

- Admiral's chair with flip up bolster
- Double wide recliner Admiral's chair

- High performance sport barrel chair with bolster

### Furniture Options

- Buckskin base vinyl (recommended only with colored wall skin)
- Luxury umbrella (Tan only) with exclusive stylish round smoked glass table with wine glass holders and stainless decorative cup holder

### Entertaining Options

- Refreshment center COMMANDER in place of lounge arm with sink, electric faucet, two gallon water reservoir, trash can liner, and stainless drawer with ice cube cooler
- Refreshment center CAPTAIN in place of lounge arm with sink, electric faucet, two gallon water reservoir, trash can liner, and smoked glass style door
- Refrigerator – DC electric stainless steel with slide out top loading cooling compartment in special housing with Corian style surface
- Stainless gas grill

### Dash/Electronics Options

- Garmin 440S Coastal GPS (upgrade exchange)

- Premium sound system upgrade (six coaxial speakers, subwoofer, amp.)
- Battery dual selector switch

### Steering Options

- Electric power assist steering

### Bimini and Hard Top Options

- Bow Bimini top – factory pre-installed only

### Performance Options

- Upgrade to 27" diameter pontoons
- Sport Graphics Package – see page 16
- Rough Water Package
- Aluminum waveshield

### Camper Enclosure Options – Factory Pre-installed Only

- 1/2 camper enclosure
- Full camper enclosure (22' and up only)

- 1/2 camper enclosure with bow cover

### Misc. Options

- Inflatable bow sleeper bed
- Livewell under port bow bench
- Wash down kit with sprayer and pump
- Seat covers in place of, or in addition to, mooring cover
- Colored wall skins – Black, Blue, Burgundy, and Champagne – Includes chrome dock light housings and custom matched graphics
- Docklines retractable built in
- Front radius deck
- Inboard/Outboard (Standard only as a Waveglider™ model) – see pages 16 and 17

## 2010 SIERRA FUNSHIP



Sierra Funship 26'

Some models shown with optional equipment.



# Tahoe

PONTOON BOATS

## A WATER PARK ON THE WATER!

Have the best of family fun every weekend with the all new Sierra Funship. Loaded with standard features to make a day on the water complete. Slide, swim, lounge, entertain, and even water-ski with the standard triple Waveglider™ high performance pontoons. Do it all and do it all at once on the Funship!

Sierra Funship 26'

# WAVEGLIDER™ SPECIFICATIONS

CLASSIC SERIES	Pontoon Length	Pontoon Diameter	Deck Width	Dry Weight	Max. Weight Capacity	Max. Engine	Max. No. Persons	Max. Person Weight
<b>GRAND TAHOE CTS</b>								
29'	28'	3-25"	8.5'	3,500	3,415	300	19	2,645
27'	26'	3-25"	8.5'	3,300	3,200	300	17	2,350
25'	24'	3-25"	8.5'	3,100	2,910	250	14	2,050
<b>SIERRA CTS</b>								
24'	24'	3-25"	8.5'	3,000	2,850	250	15	2,080
22'	22'	3-25"	8.5'	2,800	2,650	225	12	1,780
20'	20'	3-25"	8.5'	2,200	2,460	175	12	1,720
<b>SIERRA RC CTS</b>								
24'	24'	3-25"	8.5'	3,000	2,940	250	15	2,080
22'	22'	3-25"	8.5'	2,800	2,650	225	12	1,780
<b>SIERRA RCRF CTS</b>								
24'	24'	3-25"	8.5'	3,000	2,850	250	15	2,080
<b>SIERRA SANDBAR CTS</b>								
26'	26'	25"	8.5'	3,125	3,200	250	12	2,400
<b>SIERRA FUNSHIP CTS</b>								
26'	26'	25"	8.5'	3,875	3,050	250	15	2,190
<b>SE SERIES - 8 OR 8 1/2 WIDE</b>								
<b>VISTA CTS 23" DIAMETER CTS</b>								
24'	24'	3-23"	8'	2,800	2,520	200	13	1,810
22'	22'	3-23"	8'	2,600	2,265	150	11	1,560
20'	20'	3-23"	8'	2,080	2,150	135	10	1,400
18'	18'	3-23"	8'	1,875	1,850	100	9	1,290
<b>VISTA CTS 25" DIAMETER CTS</b>								
24'	24'	3-25"	8.5'	3,000	2,850	250	15	2,080
22'	22'	3-25"	8.5'	2,800	2,650	225	12	1,780
20'	20'	3-25"	8.5'	2,200	2,460	150	12	1,720
18'	18'	3-25"	8.5'	1,950	2,100	115	10	1,440
<b>VISTA RC CTS</b>								
24'	24'	3-25"	8.5'	3,000	2,850	250	15	2,080
22'	22'	3-25"	8.5'	2,800	2,650	225	12	1,780
<b>VISTA SANDBAR CTS 25" DIAMETER CTS</b>								
26'	26'	3-25"	8.5'	3,125	3,200	250	12	2,400
<b>VISTA FUNSHIP CTS 25" DIAMETER CTS</b>								
26'	26'	3-25"	8.5'	3,875	3,050	250	14	2,190
24'	24'	3-25"	8.5'	3,000	2,850	250	15	2,080
<b>BLUE RIDGE &amp; SE-B FISH 23" DIAMETER CTS</b>								
24'	24'	3-23"	8'	2,800	2,520	200	13	1,810
22'	22'	3-23"	8'	2,600	2,265	150	11	1,560
20'	20'	3-23"	8'	2,150	2,150	135	10	1,400
18'	18'	3-23"	8'	1,875	1,850	100	9	1,290
<b>BLUE RIDGE &amp; SE-B FISH 25" DIAMETER CTS</b>								
24'	24'	3-25"	8.5'	3,000	2,850	250	15	2,080
22'	22'	3-25"	8.5'	2,800	2,650	225	12	1,780
20'	20'	3-25"	8.5'	2,200	2,460	150	12	1,720
18'	18'	3-25"	8.5'	1,950	2,100	115	10	1,440
<b>CASCADE 23" DIAMETER CTS</b>								
24'	24'	3-23"	8'	2,800	2,520	200	13	1,810
22'	22'	3-23"	8'	2,600	2,265	150	11	1,560
20'	20'	3-23"	8'	2,080	2,150	135	10	1,400
18'	18'	3-23"	8'	1,875	1,890	100	9	1,290
16'	16'	3-23"	8'	1,600	1,650	75	8	1,100
<b>CASCADE 25" DIAMETER CTS</b>								
24'	24'	3-25"	8.5'	3,000	2,850	250	15	2,080
22'	22'	3-25"	8.5'	2,800	2,650	225	12	1,780
20'	20'	3-25"	8.5'	2,200	2,460	175	12	1,720
18'	18'	3-25"	8.5'	1,950	2,100	115	10	1,440
<b>SE-C FNF 23" DIAMETER CTS</b>								
24'	24'	3-23"	8'	2,800	2,520	200	13	1,810
22'	22'	3-23"	8'	2,600	2,265	150	11	1,560
20'	20'	3-23"	8'	2,080	2,150	135	10	1,400
18'	18'	3-23"	8'	1,875	1,890	100	9	1,290
<b>SE-C FNF 25" DIAMETER CTS</b>								
24'	24'	3-25"	8.5'	3,000	2,850	250	15	2,080
22'	22'	3-25"	8.5'	2,800	2,650	225	12	1,780
20'	20'	3-25"	8.5'	2,200	2,460	175	12	1,720
18'	18'	3-25"	8.5'	1,950	2,100	115	10	1,440
16'	16'	3-25"	8.5'	1,700	1,860	90	9	1,300
<b>SPORT 22" DIAMETER CTS</b>								
16'	16'	3-22"	7'	1,500	1,550	75	7	990
14'	14'	3-22"	7'	1,350	1,300	50	5	800
<b>SPORT 23" DIAMETER CTS</b>								
16'	16'	3-23"	7'	1,600	1,650	75	8	1,100
14'	14'	3-23"	7'	1,400	1,360	60	6	840

# WAVEGLIDER™ HIGH PERFORMANCE PACKAGES

## WAVEGLIDER™ HIGH PERFORMANCE SYSTEM PROVEN PERFORMANCE AND DURABILITY!

Tahoe has tested our High Performance System on trips from Baltimore to Key West, across Lake Michigan and across the ocean from Ft. Lauderdale to Bimini in the Bahamas, and Key West to the Dry Tortugas. So you can be assured of one tough, high performance boat. So go ahead and turn your boat into the fast planing sport boat you want. It will be a blast to drive, a great all around family boat and perfect for pulling skiers, tubes, and wakeboards.\*



• Waveglider™ High Performance System – 23" or 25" dia. triple pontoons, high performance lifting strakes, Sea Star hydraulic steering, and 42 gallon fuel tank for center pontoon



Waveglider™ with aluminum wavelshields



Some models shown with optional equipment.

## WAVEGLIDER™ WATERSPORTS PACKAGE

- Waveglider™ Watersports package includes Waveglider™ High Performance System – plus: ski tow bar and aluminum wavelshields

## WAVEGLIDER™ 5X7 TURNING PACKAGE

- Take it to the next level by equipping your craft with the Tahoe Waveglider™ 5X7 High Performance Turning Package. For O/B models it includes the Waveglider™ Watersports package with 25" outside pontoons PLUS an upgrade to a 27" diameter Waveglider™ center pontoon, and electric power assist steering for sharper turns!

Just add a 27" center pontoon on an I/O to go 5X7!

\* Note – 5X7 Package is not available on Funship models or any model with a walk on sunroof.



# Tahoe

PONTOON BOATS



## OPTIONAL SPORT GRAPHICS PACKAGE

- Yellow Fire – Fire Graphics, yellow interior with black accent, yellow dash, steering wheel, and yellow accent sport barrel chair with bolster
- Red Fire – Fire Graphics, red interior with black accent, red dash, steering wheel, and red accent sport barrel chair with bolster
- Black Fire – For black wall skin boats – Fire Graphics, black interior with tan accent, Carbon fiber dash, steering wheel, and black accent sport barrel chair with bolster.



\* Also includes stainless steel speaker covers on "SE" Series models

## INBOARD/OUTBOARD OPTIONS CLASSIC SERIES ONLY

I/O Mercruiser – Classic Series only includes: standard 350 MAG MPI 300 HP Sterndrive with Bravo III outdrive, twin stainless steel propellers, Corsa Captain's choice exhaust, Waveglider™ High Performance System 25" dia. triple pontoons, high performance lifting strakes, Sea Star hydraulic steering, and 42 gallon fuel tank for center pontoon, power assist steering, ski tow bar I/O, bilge pump, additional oil and temp gauge, exhaust blower, and aluminum waveshield.

### INBOARD/OUTBOARD FEATURES



Bravo 3 dual prop outdrive



Corsa through hull exhaust



Power assist steering



Aluminum waveshield



Some models shown with optional equipment.

Optional Inboard/Outboard fiberglass full width rear swim platform



## WATERSPORTS & PERFORMANCE OPTIONS

### PERFORMANCE OPTIONS

- Rough Water Package (factory installed only for Waveglider™ and 5 X 7) – suggested when boat is going to be consistently exposed to very rough water. Adds extra welding and extreme duty riser components
- Aluminum waveshield (factory installed only) – prevents water from hitting crossbeams and under side of deck while underway

### WATERSPORTS OPTIONS

- Ski tow bar – allows convenient towing for skiers and tubes
- Waterski/wakeboard tower – 8.5' wide only (Includes SS Bimini top) provides preferred elevation of the ski pylon for wakeboarders and advanced skiers.\*

- In floor storage compartment – factory installed only in center pontoon models

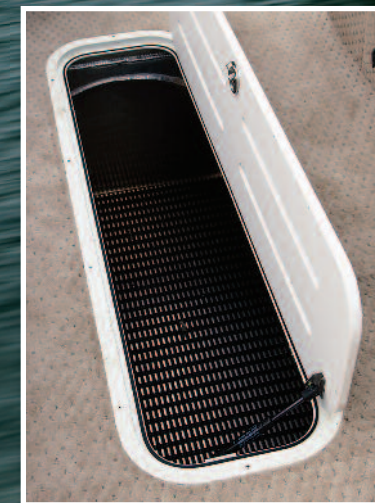

- Power assist steering – Add power assist steering to give your boat even better handling and turning capability – requires upgrade to Sea Star Hydraulic steering



### TOWER OPTIONS

- High power speakers with microphone
- Spotlight
- Tower racks (four pieces – two sides)



High performance options are available factory installed only!

\*Please follow all safety rules when towing watersports equipment. Do not overload ski tow bar or Waterski/wakeboard tower.

## STANDARD FEATURES

### Helmman

#### Fiberglass Stand

- Level 3 helm package – carbon fiber dash with platinum panels lighted stainless toggle switches, quick release windshield, smoked glass side door, 25 qt. cooler, removable stand access panel, and glove box
- Full gauge panel featuring black sterling tachometer, voltmeter, and fuel gauge
- Surface storage trays for cell phone and other personal items
- Carbon fiber tilt steering wheel with brilliant aluminum non-directional spokes

#### Electronics

- Jensen high power MSR3007 CD stereo with MP3 plug

- Two Jensen high power speakers with platinum speaker covers
- 12 volt power point

#### Lighting

- Docking lights built into front walls in heavy duty reinforced housing
- Stainless courtesy light on side of Captain's stand
- USCG navigation and stern lighting

#### Furnishings

- Furnishings are created using exclusive MATRIX 50 marine upholstery
- Upholstered aluminum seat frames with flow through ventilation
- Plated plush radius designer furnishings
- Champagne perf accent vinyl
- Plush deluxe lounge arms

- Plush fixed back Captain's chair with moveable arms and slide and swivel
- Portable cup holders

#### Styling

- Front radius wall railings
- Rear entry gate with swim platform rear entry ladder
- External wall skins with 29" high 1 1/4" diameter .090" anodized railings
- Hidden wall seams
- Non-skid strips for doorways
- Plush 20 oz. textured carpet
- Deluxe mural graphics package
- Three dimensional raised logos

#### Convenience

- Fire extinguisher
- Four stainless cleat and lifting eye assembly
- 24 gallon fuel capacity
- Oval table with cup holders

## OPTIONS

#### 8.5" wide option – includes:

- 25" diameter pontoons
- Plush 28 oz. Escalade carpet
- 8 1/2" x 10" Bimini top

#### Deck Options

- Aluminum decking

#### Flooring Options

- Vinyl flooring (n/a on aluminum deck)
- Snap-in carpet (upgrade to vinyl flooring also required)
- Plush 28 oz. Escalade carpet
- Plush 28 oz. Islands carpet

#### Captain's Chair Options

- Exclusive Comfort-Plush™ high back reclining Admiral's chair

- Exclusive Comfort-Plush™ low back reclining Commander's chair
- Double wide recliner Admiral's chair

#### Furniture Options

- Buckskin base vinyl (recommended only with colored wall skin)
- Smoked glass table with wine glass holders and stainless decorative cup holder
- Luxury umbrella with table (Tan only)

- Luxury umbrella (Tan only) with exclusive stylish round smoked glass table with wine glass holders and stainless decorative cup holder

#### Entertaining Options

- Refreshment center COMMANDER in place of lounge arm with sink, electric faucet, two gallon water reservoir, trash can liner, and stainless drawer with ice cube cooler
- Refreshment center CAPTAIN in place of lounge arm with sink, electric faucet, two gallon water reservoir, trash can liner, and smoked glass style door

- Convenience center with Corian style surface, paper towel holder, and storage
- Refrigerator – DC electric stainless steel with slide out top loading cooling compartment in special housing with Corian style surface
- Stainless gas grill

#### Dash/Electronics Options

- Garmin 430S full color GPS with built in inland maps, fishfinder water temp, depth gauge, speedometer
- Garmin 440S GPS with coastal maps
- Fishfinder – Garmin color (model 400C)
- Premium sound system upgrade (six coaxial speakers, subwoofer, amp.)
- Jensen waterproof CD stereo MSR7007 exchange
- Jensen MSR2107 high power waterproof stereo with 1 GB storage and memory stick input (exchange)
- Extra Jensen speakers
- Marine Audio speakers
- Stainless logo speaker covers (requires M.A. speaker)
- Dual battery system with auto twin charge and start protect
- Battery selector switch

#### Lighting Options

- Stainless amber floor mood lighting
- Engine compartment light

#### Steering Options

- Baystar hydraulic easy to turn tilt steering

## INTERIOR OPTIONS

### REAR ENTRY



18'

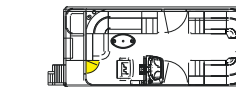

20'

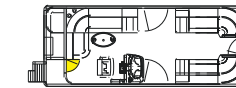

22'

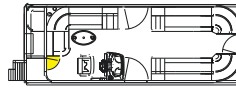

24'

### ELITE

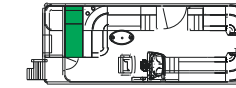

22'

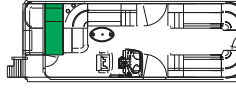

24'

- Sea Star hydraulic steering for motors over 150 hp
- Electric power assist steering (requires Sea Star upgrade)

#### Bimini and Hard Top Options

- 8' x 10' Bimini top with boot
- Six stainless steel easy to use twist lock Bimini quick connect (available only on 8 1/2" x 10" Bimini top)
- Second Bimini top – factory pre-installed only
- Standard walk-on sun roof (8' or 10') with ladder (ladder at front of roof except 8' on Elite models). Upgrade to 25" pontoons required. Available factory installed only, 22' and up only
- 12' aluminum hard top (factory installed only)

#### Pontoon Options

- 23" to 25" upgrade
- Exclusive side protector keels

#### Performance options

- Waveglider™ high performance pontoons – see pages 14 and 15
- Sport Graphics Package – see page 16
- Aluminum waveshield

#### Watersports Options

- Ski tow bar
- Waterski/wakeboard tower – 8.5" wide only

#### Camper Enclosure Options – Factory Pre-installed Only

- 1/2 camper enclosure (22' and up only)
- 1/2 camper enclosure with bow cover

#### Misc. Options

- Inflatable bow sleeper bed
- Livewell under port bow bench
- Wash down kit with sprayer and pump
- Seat covers in place of, or in addition to, mooring cover
- Colored wall skins – Black, Blue, Burgundy, and Champagne – Includes chrome dock light housings and custom matched graphics
- Docklines retractable built in
- Stainless steel non-skid strips for doorways
- Trash can built into lounge arm
- Wine rack built in to lounge arm
- Four eye straps to mount fenders
- Four stainless pop up cleats

## 2010 VISTA

# Tahoe

## PONTOON BOATS



Vista 18' RE



Vista 22' RD



Vista 20' RE

Vista 24' Elite

## BEAUTIFUL AND LUXURIOUS BEST DESCRIBES THE TAHOE VISTA.

It is the smart choice for families looking for an affordable luxury pontoon. Standard features include heavy-duty construction, 16" on-center crossbeams, plush custom-designed furnishings with soft lounge arms, a CD Player, a great Captain's chair, ladder, tilt steering, built-in dock lights and a mooring cover. And all for a fantastic price.

Some models shown with optional equipment.

## STANDARD FEATURES

### Helmsman

#### Fiberglass Stand

- Level 3 helm package – carbon fiber dash with platinum panels lighted stainless toggle switches, quick release windshield, smoked glass side door, 25 qt. cooler, removable stand access panel, and glove box
- Full gauge panel featuring black sterling tachometer, voltmeter, and fuel gauge
- Surface storage tray for cell phone and other personal items
- Carbon fiber tilt steering wheel with brilliant aluminum non-directional spokes

### Electronics

- Jensen high power MSR3007 CD stereo with MP3 plug
- 12 volt power point

### Lighting

- Docking lights built into front walls in heavy duty reinforced housing
- Stainless courtesy light on side of Captain's stand
- USCG navigation and stern lighting

### Furnishings

- Furnishings are created using exclusive MATRIX 50 marine upholstery
- Upholstered aluminum seat frames with flow through ventilation
- Pleated plush radius designer furnishings
- Champagne perf accent vinyl
- Plush deluxe lounge arms

- Portable cup holders
- Exclusive Comfort-Plush™ high back reclining drivers Admiral's chair with slide and swivel

- Fire extinguisher
- Four stainless cleat and lifting eye assembly
- Oval table with cup holders

- Canvas and Top
- 10' Bimini top with boot
- Transport position support brackets
- Bimini quick release pull pins
- Color matched full mooring cover with vented pole supports

- Construction
- 8 1/2" wide
- 25" diameter pontoons
- Double full riser connections
- Heavy duty 3" reinforced deck rail
- Heavy duty C-channel crossbeams

- Stainless logo speaker covers (requires M.A. speaker)
- Dual battery system with auto twin charge and start protect
- Battery selector switch

- Lighting Options
- Stainless amber floor mood lighting

- Steering Options
- Electric power assist steering (requires Sea Star upgrade)

- Bimini and Hard Top Options
- Six stainless steel easy to use twist lock Bimini quick connect
- Second Bimini top – factory pre-installed only
- Standard walk-on sun roof (8' or 10') with ladder (ladder at front of roof except 8' on Elite models)
- 12' aluminum hard top (factory installed only)

- Refreshment center COMMANDER in place of lounge arm with sink, electric faucet, two gallon water reservoir, trash can liner, and stainless drawer with ice cube cooler
- Dash/Electronics Options
- Garmin 430S full color GPS with built in inland maps, fishfinder water temp, depth gauge, speedometer
- Garmin 440S GPS with coastal maps
- Fishfinder – Garmin color (Model 400C)
- Premium sound system upgrade (six coaxial speakers, subwoofer, amp.)
- Jensen waterproof CD stereo MSR7007 exchange
- Jensen MSR2107 high power waterproof stereo with 1 GB storage and memory stick input (exchange)
- Extra Jensen speakers
- Marine Audio speakers

- 16" OC crossbeam spacing
- Corner castings all four corners
- Gate latches with stainless steel insert and welded safety tab

### SPECIAL FEATURES – VISTA RC

- Two Jensen high power speakers with platinum speaker covers
- Two exclusive Comfort-Plush™ bow low back reclining Commander's chairs with slide and swivel
- Livewell under port bow bench
- Rod holders and cup holders at bow
- Rear entry gate with swim platform rear entry ladder
- 24 gallon fuel capacity
- Extra heavy duty motor pod double bolted with 3/8" SST bolts attached to seven crossbeams
- Second oval table at bow

### SPECIAL FEATURES – VISTA SANDBAR

- Captain refreshment center in place of lounge arm with sink, electric faucet, two gallon water reservoir, trash can liner, and smoked glass style door
- Large rear swim platform area
- Waveglider™ high performance 25" triple pontoons and Tahoe's exclusive Waveglider™ – high performance lifting strakes and 42 gallon fuel tank for center pontoon
- Ski tow bar
- Sea Star hydraulic steering
- Four Jensen high power speakers with platinum speaker covers
- Rear facing side bench

### Pontoon Options

- Exclusive side protector keels
- Performance Options
- Sport Graphics Package – see page 16
- Aluminum waveshield

### Camper Enclosure Options – Factory Pre-installed Only

- 1/2 camper enclosure (22' and up only)
- 1/2 camper enclosure with bow cover

### Misc. Options

- Refrigerator – DC electric stainless steel with slide out top loading cooling compartment in special housing with Corian style surface
- Inflatable bow sleeper bed
- Stainless gas grill
- Wash down kit with sprayer and pump

## INTERIOR OPTIONS

### VISTA RC

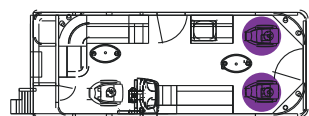

RE

22'

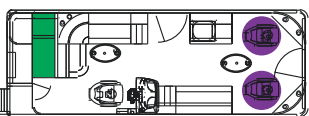

ELITE

24'

### VISTA SANDBAR

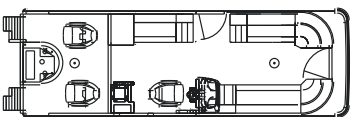

26'

- Rear bar and music center includes cup holders, remote stereo controls, 12 volt outlet, storage, and cube cooler
- Two Rear Admiral's recliner chairs

- Waveglider™ high performance 25" triple pontoons and Tahoe's exclusive Waveglider™ – high performance lifting strakes and 42 gallon fuel tank for center pontoon
- Ski tow bar
- Sea Star hydraulic steering
- Four Jensen high power speakers with platinum speaker covers
- Rear facing side bench

- Seat covers in place of, or in addition to, mooring cover
- Colored wall skins – Black, Blue, Burgundy, and Champagne – includes chrome dock light housings and custom matched graphics
- Docklines retractable built in
- Stainless steel non-skid strips for doorways
- Trash can built into lounge arm
- Wine rack built in to lounge arm
- Four eye straps to mount fenders
- Four stainless pop up cleats
- Exclusive side protector keels
- Waterski/wakeboard tower
- Exclusive side protector keels

### SPECIAL OPTIONS – VISTA RC

- Refreshment center CAPTAIN in place of lounge arm with sink, electric faucet, two gallon water reservoir, trash can liner, and smoked glass style door
- Engine compartment light
- Baystar hydraulic easy to turn tilt steering
- Sea Star hydraulic steering for motors over 150 hp
- Waveglider™ high performance pontoons – see pages 14 and 15
- Waterski/wakeboard tower – Convenience center with Corian style surface, paper towel holder, and storage
- Ski tow bar

## 2010 VISTA RC

### VISTA RC IS THE MORE AFFORDABLE ENTERTAINMENT BOAT.

Its plush bow seating not only offers a nice place to sit and relax, it also serves as a fishing station with many fishing features including a livewell and rod holders.



Some models shown with optional equipment.



Vista RC 24' Elite

Vista RC 22' RE



## 2010 VISTA SANDBAR

### GET READY TO PARTY!

Park at your favorite cove and watch how a great stereo, the standard rear entertainment bar, and the easy access rear deck with plenty of dancing room will have everyone coming to your Sandbar to party the day away!



Vista Sandbar 26'

Vista Sandbar 26'

Some models shown with optional equipment.

# Tahoe

PONTOON BOATS

## SPECIFICATIONS

	RC	RC	Sandbar
<b>LENGTH</b>	22'	24'	26'
Pontoon Diameter	25"	25"	25"
Width	8 1/2'	8 1/2'	8 1/2'
Dry Weight	2,050	2,250	3,875
Max Weight Cap.	2,260	2,600	3,050
Max Engine HP	125	150	275
Max # People	11	13	12
Max People Lbs.	1,600	1,850	2,190

## OPTIONS

### Deck Options

- Aluminum decking

### Flooring Options

- Vinyl flooring (n/a on aluminum deck, n/a on rear deck of sandbar)
- Snap-in carpet (upgrade to vinyl flooring also required)
- Plush 28 oz. Islands carpet

### Captain's Chair Options

- Double wide recliner Admiral's chair

### Furniture Options

- Buckskin base vinyl (recommended only with colored wall skin)
- Smoked glass table with wine glass holders and stainless decorative cup holder
- Luxury umbrella with table (Tan only)
- Luxury umbrella (Tan only) with exclusive stylish round smoked glass table with wine glass holders and stainless decorative cup holder

- Refreshment center COMMANDER in place of lounge arm with sink, electric faucet, two gallon water reservoir, trash can liner, and stainless drawer with ice cube cooler

### Dash/Electronics Options

- Garmin 430S full color GPS with built in inland maps, fishfinder water temp, depth gauge, speedometer
- Garmin 440S GPS with coastal maps
- Fishfinder – Garmin color (Model 400C)
- Premium sound system upgrade (six coaxial speakers, subwoofer, amp.)
- Jensen waterproof CD stereo MSR7007 exchange
- Jensen MSR2107 high power waterproof stereo with 1 GB storage and memory stick input (exchange)
- Extra Jensen speakers
- Marine Audio speakers

## STANDARD FEATURES

### Funship Special Equipment

- Deluxe 10' walk-on sun roof with rear ladder, Waterpark™ slide with waterfall water pump, decorative walls, king size upper deck lounge with backs and cushions, upper deck entertainment center with remote, stereo controls, two speakers, and storage

### Performance

- Waveglider™ high performance pontoons – includes 25" triple pontoons and Tahoe's exclusive Waveglider™ – high performance lifting strakes and 42 gallon fuel tank for center pontoon
- Ski tow bar

### Helmsman Fiberglass Stand

- Carbon fiber dash with platinum panels lighted stainless toggle switches, quick release windshield, smoked glass side door, 25 qt. cooler, removable stand access panel and glove box
- Sea Star hydraulic steering
- Full gauge panel featuring black sterling tachometer, voltmeter, and fuel gauge
- Surface storage tray for cell phone and other personal items
- Carbon fiber tilt steering wheel with brilliant aluminum non-directional spokes

### Electronics

- Jensen high power MSR3007 CD stereo with MP3 plug
- Two Jensen high power speakers with platinum speaker covers
- 12 volt power point

### Lighting

- Docking lights built into front walls in heavy duty reinforced housing
- Stainless courtesy light on side of Captain's stand
- USCG navigation and stern lighting

### Furnishings

- Furnishings are created using exclusive MATRIX 50 marine upholstery
- Upholstered aluminum seat frames with flow through ventilation
- Pleated plush radius designer furnishings
- Champagne perf accent vinyl
- Plush deluxe lounge arms
- Plush fixed back Captain's chair with moveable arms and slide and swivel
- Portable cup holders

## INTERIOR OPTIONS

### VISTA FUNSHIP

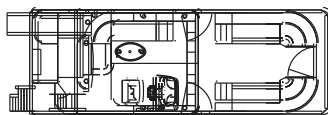

24'

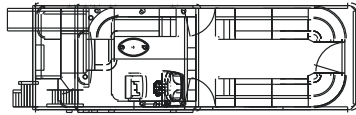

26'

### Styling

- Front radius wall railings
- Rear entry gate with swim platform rear entry ladder
- External wall skins with 29" high 1 1/4" diameter .090" anodized railings
- Hidden wall seams
- Non-skid strips for doorways
- Plush 28 oz. Escalade carpet
- Deluxe mural graphics package
- Three dimensional raised logos

### Convenience

- Fire extinguisher
- Four stainless cleat and lifting eye assembly
- Oval table with cup holders

### Canvas and Top

- Color matched full mooring cover with vented pole supports

### Construction

- 8 1/2" wide
- Double full riser connections
- Heavy duty 3" reinforced deck rail
- Heavy duty C-channel crossbeams
- 16" OC crossbeam spacing
- Corner castings all four corners
- Gate latches with stainless steel insert and welded safety tab

## SPECIFICATIONS

LENGTH	24'	26'
Pontoon Diameter	25"	25"
Width	8 1/2'	8 1/2'
Dry Weight	3,750	3,875
Max Weight Cap.	2,735	3,050
Max Engine HP	225	275
Max # People	14	15
Max People Lbs.	1,990	2,190

## OPTIONS

### Deck Options

- Aluminum decking

### Flooring Options

- Vinyl flooring (n/a on aluminum deck)
- Snap-in carpet (upgrade to vinyl flooring also required)
- Plush 28 oz. Islands carpet

### Captain's Chair Options

- Exclusive Comfort-Plush™ high back reclining Admiral's chair
- Exclusive Comfort-Plush™ low back reclining Commander's chair
- Double wide recliner Admiral's chair

### Furniture Options

- Buckskin base vinyl (recommended only with colored wall skin)
- Smoked glass table with wine glass holders and stainless decorative cup holder
- Luxury umbrella with table (Tan only)

- Luxury umbrella (Tan only) with exclusive stylish round smoked glass table with wine glass holders and stainless decorative cup holder

### Entertaining Options

- Refreshment center COMMANDER in place of lounge arm with sink, electric faucet, two gallon water reservoir, trash can liner, and stainless drawer with ice cube cooler
- Refreshment center CAPTAIN in place of lounge arm with sink, electric faucet, two gallon water reservoir, trash can liner, and smoked glass style door
- Convenience center with Corian style surface, paper towel holder, and storage
- Refrigerator – DC electric stainless steel with slide out top loading cooling compartment in special housing with Corian style surface
- Stainless gas grill

### Dash/Electronics Options

- Garmin 430S full color GPS with built in inland maps, fishfinder water temp, depth gauge, speedometer
- Garmin 440S GPS with coastal maps
- Fishfinder – Garmin color (Model 400C)
- Premium sound system upgrade (six coaxial speakers, subwoofer, amp.)
- Jensen waterproof CD stereo MSR7007 exchange
- Jensen MSR2107 high power waterproof stereo with 1 GB storage and memory stick input (exchange)
- Extra Jensen speakers
- Marine Audio speakers
- Stainless logo speaker covers (requires M.A. speaker)
- Dual battery system with auto twin charge and start protect
- Battery selector switch

### Lighting Options

- Stainless amber floor mood lighting
- Engine compartment light

### Steering Options

- Electric power assist steering

### Bimini and Hard Top Options

- Second Bimini top – factory pre-installed only

### Pontoon Options

- Exclusive side protector keels
- Upgrade to 27" diameter pontoons

### Performance Options

- Sport Graphics Package – see page 16
- Aluminum waveshield

### Camper Enclosure Options – Factory Pre-installed Only

- 1/2 camper enclosure
- Full camper enclosure (22" and up only)
- 1/2 camper enclosure with bow cover

### Misc. Options

- Inflatable bow sleeper bed
- Livewell under port bow bench
- Wash down kit with sprayer and pump
- Seat covers in place of, or in addition to, mooring cover
- Colored wall skins – Black, Blue, Burgundy, and Champagne – includes chrome dock light housings and custom matched graphics
- Docklines retractable built in
- Stainless steel non-skid strips for doorways
- Trash can built into lounge arm
- Wine rack built in to lounge arm
- Four eye straps to mount fenders
- Four stainless pop up cleats

## 2010 VISTA FUNSHIP



Now everyone can enjoy a day of sliding, skiing, sunbathing, and cruising with the most affordable water park model anywhere! Enjoy Vista features plus the slide, king size sunbathing area, and Tahoe's Waveglider™ system for a complete do-everything Funship!



Vista Funship 24'



Vista Funship 26'

# Tahoe

PONTOON BOATS

Some models shown with optional equipment.

## STANDARD FEATURES

- Helmsman Fiberglass Stand**
- Level 3 helm package – carbon fiber dash with platinum panels lighted stainless toggle switches, quick release windshield, smoked glass side door, 25 qt. cooler, removable stand access panel, and glove box
  - Full gauge panel featuring black sterling tachometer, voltmeter, and fuel gauge
  - Surface storage tray for cell phone and other personal items
  - Carbon fiber steering wheel with brilliant aluminum non-directional spokes
- Electronics**
- Jensen high power MSR3007 CD stereo with MP3 plug
  - Two Jensen high power speakers with platinum speaker covers
  - 12 volt power point
- Lighting**
- Docking lights built into front walls in heavy duty reinforced housing
  - Stainless courtesy light on side of Captain's stand
  - USCG navigation and stern lighting
- Furnishings**
- Furnishings are created using exclusive MATRIX 50 marine upholstery
  - Upholstered aluminum seat frames with flow through ventilation

- Pleated plush designer furnishings
  - Champagne perf accent vinyl
  - Plush deluxe lounge arms
  - Plush fixed back Captain's chair with moveable arms and slide and swivel
  - Portable cup holders
- Styling**
- Traditional wall railings
  - Rear entry gate with swim platform rear entry ladder
  - External wall skins with 29" high 1 1/4" diameter .090" anodized railings
  - Hidden wall seams
  - Non-skid strips for doorways

- Construction**
- 8' standard or optional 8 1/2' wide
  - 23" standard or optional 25" diameter pontoons
  - Plush fixed back riser connections
  - Heavy duty 3" reinforced deck rail
  - Heavy duty C-channel crossbeams
  - 16" OC crossbeam spacing
  - Corner castings all four corners
  - Extra heavy duty motor pod double bolted with 3/8" SST bolts attached to seven crossbeams
  - Gate latches with stainless steel insert and welded safety tab
- Convenience**
- Fire extinguisher
  - Four stainless cleat and lifting eye assembly
  - 24 gallon fuel capacity
  - Oval table with cup holders
- Canvas and Top**
- 8' Bimini top with boot
  - Transport position support brackets
  - Bimini quick release pull pins
  - Color matched full mooring cover with vented pole supports

## INTERIOR OPTIONS

### REAR ENTRY

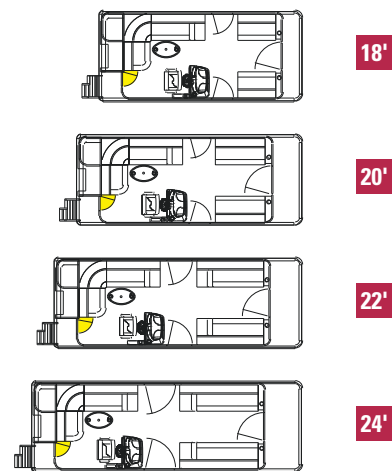

### ELITE

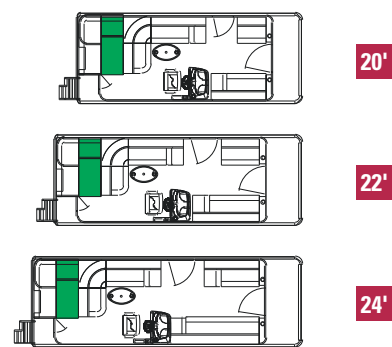

## OPTIONS

- 8.5' wide option – Includes:**
- 25" diameter pontoons
  - Plush 28 oz. Escalade carpet
  - 8 1/2' x 10' Bimini top
- Deck Options**
- Aluminum decking
- Flooring Options**
- Vinyl flooring (n/a on aluminum deck)
  - Snap-in carpet (upgrade to vinyl flooring also required)
  - Plush 28 oz. Escalade carpet
  - Plush 28 oz. Islands carpet
- Captain's Chair Options**
- Exclusive Comfort-Plush™ high back reclining Admiral's chair
  - Exclusive Comfort-Plush™ low back reclining Commander's chair
  - Double wide recliner Admiral's chair
- Furniture Options**
- Buckskin base vinyl (recommended only with colored wall skin)
  - Smoked glass table with wine glass holders and stainless decorative cup holder

- Luxury umbrella with table (Tan only)
  - Luxury umbrella (Tan only) with exclusive stylish round smoked glass table with wine glass holders and stainless decorative cup holder
- Refreshment center CAPTAIN** in place of lounge arm with sink, electric faucet, two gallon water reservoir, trash can liner, and smoked glass style door
- Convenience center** with Corian style surface, paper towel holder, and storage
- Refrigerator** – DC electric stainless steel with slide out top loading cooling compartment in special housing with Corian style surface
- Stainless gas grill**

- Dual battery system with auto twin charge and start protect
  - Battery selector switch
- Lighting Options**
- Stainless amber floor mood lighting
  - Engine compartment light
- Steering Options**
- Mechanical tilt steering
  - Baystar hydraulic easy to turn tilt steering
  - Sea Star hydraulic tilt steering for motors over 150 hp
  - Electric power assist steering (requires Sea Star upgrade)

- Dash/Electronics Options**
- Garmin 430S full color GPS with built in inland maps, fishfinder water temp, depth gauge, speedometer
  - Garmin 440S GPS (with coastal maps)
  - Fishfinder – Garmin color (Model 400C)
  - Premium sound system upgrade (six coaxial speakers, subwoofer, amp.)
  - Jensen waterproof CD stereo MSR7007 exchange
  - Jensen MSR2107 high power waterproof stereo with 1 GB storage and memory stick input (exchange)
  - Extra Jensen speakers
  - Marine Audio speakers
  - Stainless logo speaker covers (requires M.A. speaker)

- Seat covers in place of, or in addition to, mooring cover
- Colored wall skins – Black, Blue, Burgundy, and Champagne – Includes chrome dock light housings and custom matched graphics
- Docklines retractable built in
- Stainless steel non-skid strips for doorways
- Trash can built into lounge arm
- Wine rack built in to lounge arm
- Four eye straps to mount fenders
- Four stainless pop up cleats

## SPECIFICATIONS

LENGTH	18'	20'	22'	24'
<b>Standard Pontoon Diameter</b>	23"	23"	23"	23"
Standard Width	8'	8'	8'	8'
Dry Weight	1,600	1,750	2,000	2,200
Max Weight Cap.	1,575	1,805	2,000	2,210
Max Engine HP	75	90	100	130
Max # People	8	9	10	11
Max People Lbs.	1,070	1,250	1,450	1,530
<b>Optional Width</b>	<b>8 1/2'</b>	<b>8 1/2'</b>	<b>8 1/2'</b>	<b>8 1/2'</b>
Optional Pontoon Diameter	25"	25"	25"	25"
Dry Weight	1,650	1,800	2,050	2,250
Max Weight Cap.	1,870	2,130	2,350	2,600
Max Engine HP	90	115	125	150
Max # People	9	10	11	13
Max People Lbs.	1,270	1,380	1,600	1,850

## 2010 BLUE RIDGE

Blue Ridge 24' RD



Blue Ridge 18' RE



Blue Ridge 20' RE

## A BESTSELLER FOR YEARS.

The affordable, durable and feature-packed Blue Ridge has been a favorite for thousands of families! Enjoy lounge arms, soft plush furnishings, a CD stereo, built-in dock lights, and a luxurious Captain's chair all mounted on heavy-duty construction with 16" on-center crossbeams and full riser connectors. It's built to create memories for many years to come.



Blue Ridge 22' RE

Some models shown with optional equipment.

**Tahoe**  
PONTON BOATS

## STANDARD FEATURES

- Captain's deluxe polished contoured stand
- Level 2 helm package – carbon fiber dash lighted rocker switches, quick release windshield
- Smoked glass side door, removable stand access panel and glove box
- Full gauge panel featuring black sterling tachometer, voltmeter, and fuel gauge
- MP3 player storage bin with smoked glass lid
- Surface storage tray for cell phone and other personal items
- Black steering wheel with brilliant aluminum non-directional spokes

### Electronics

- Jensen high power MSR3007 CD stereo with MP3 plug
- Two Jensen high power speakers with platinum speaker covers
- 12 volt power point
- Garmin in dash fishfinder – graph Model 145

### Lighting

- Docking lights built into front walls in heavy duty reinforced housing
- Stainless courtesy light on side of Captain's stand
- USCG navigation and stern lighting

### Furnishings

- Furnishings are created using exclusive MATRIX 50 marine upholstery

- Upholstered aluminum seat frames with flow through ventilation
- Plush designer furnishings
- Champagne perf accent vinyl
- Plush redesigned lounge arms (where applicable)
- Plush fixed back Captain's chair with moveable arms and slide and swivel

### Fishing Features

- Two front fishing stations with rod holder (FNF, FNC)
- Two rear fishing stations with rod holder (FNF, FNC, RF, RFC)
- Side privacy station (FNF, FNC, RF, RFC)
- Rear rod box (FNF, FNC, RF, RFC)
- Tackle trays (FNF, FNC, RF, RFC)
- Large livewell over fuel tank (FNF, FNC, RF, RFC)
- Small livewell under bow fish chair (FNF, FNC)
- Livewell under port bow bench (BF)
- Two bow benches (RF, RFC, FNC, BF)
- Two fish chairs on front deck (BF)

### Canvas and Top

- 8' Bimini top with boot
- Transport position support brackets
- Bimini quick release pull pins
- Color matched full mooring cover with vented pole supports

### Styling

- Rear entry gate with swim platform rear entry ladder
- External wall skins with 29" high 1 1/4" diameter .090" anodized railings
- Hidden wall seams
- Non-skid strips for doorways

- Plush 20 oz. textured carpet
- Deluxe mural graphics package

### Convenience

- Fire extinguisher
- Four stainless cleat and lifting eye assembly
- 24 gallon fuel capacity
- Oval table with cup holders

### Construction

- 8' standard or optional 8 1/2" wide 23" diameter pontoons
- Double full riser connections
- Heavy duty 3" reinforced deck rail
- Heavy duty C-channel crossbeams
- 16" OC crossbeam spacing
- Corner castings all four corners
- Extra heavy duty motor pod double bolted with 3/8" SST bolts attached to seven crossbeams
- Gate latches with stainless steel insert and welded safety tab

### Canvas and Top

- 8' Bimini top with boot
- Transport position support brackets
- Bimini quick release pull pins
- Color matched full mooring cover with vented pole supports

## INTERIOR OPTIONS

### BOW FISH RE

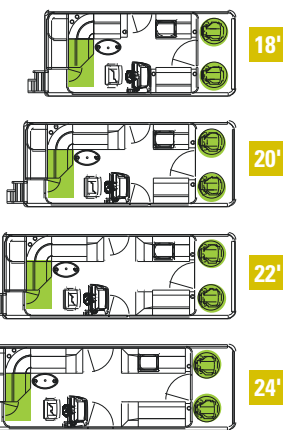

### FISH N' FUN RE

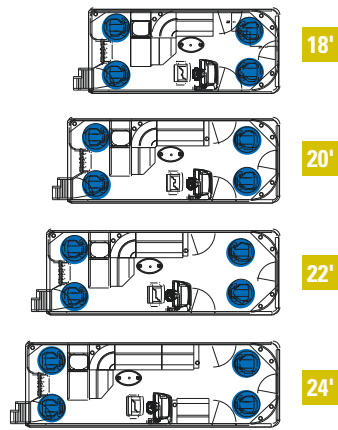

### REAR FISH RE

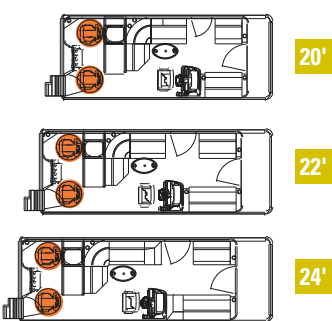

### REAR FISH CRUISE RE

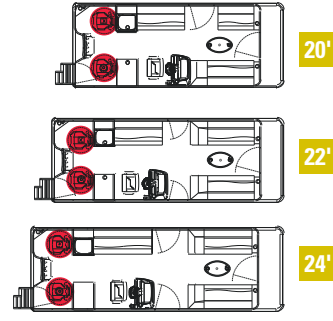

### FISH N' CRUISE RE

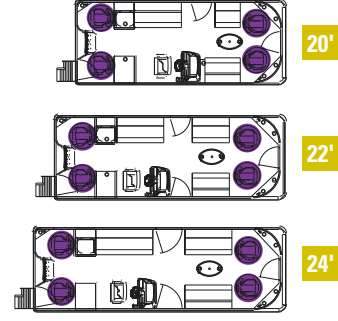

## OPTIONS

### 8.5' Wide Option – Includes:

- 25" diameter pontoons
- Plush 28 oz. Escalade carpet
- 8 1/2' x 10' Bimini top with boot

### Deck Options

- Aluminum decking

### Flooring Options

- Vinyl flooring (n/a on aluminum deck)
- Snap-in carpet (upgrade to vinyl flooring also required)
- Plush 28 oz. Escalade carpet
- Plush 28 oz. Islands carpet

### Captain's Chair Options

- High back reclining Admiral's chair (except FNC and RFC)

- Low back reclining Commander's chair (except FNC and RFC)
- Double wide recliner Admiral's chair (except FNC and RFC)

### Furniture Options

- Buckskin base vinyl (recommended only with colored wall skin)
- Smoked glass table with wine glass holders and stainless decorative cup holder
- Luxury umbrella with table (Tan only)
- Luxury umbrella (Tan only) with exclusive stylish round smoked glass table with wine glass holders and stainless decorative cup holder

### Dash/Electronics Options

- Garmin 430S full color GPS (factory installed only) or (requires upgrade to level 3 dash)
- Garmin 440S full color coastal GPS (factory installed only) or (requires upgrade to level 3 dash)
- Premium sound system upgrade (six coaxial speakers, subwoofer, amp.)
- Jensen waterproof CD stereo MSR7007 exchange
- Jensen MSR2107 high power waterproof stereo with 1 GB storage and memory stick input (exchange)
- Extra Jensen speakers

- Marine Audio speakers
- Stainless logo speaker covers (requires M.A. speaker)
- Dual battery system with auto twin charge and start protect
- Battery selector switch

### Lighting Options

- Stainless amber floor mood lighting
- Engine compartment light

### Steering Options

- Mechanical tilt steering
- Baystar hydraulic easy to turn tilt steering
- Sea Star hydraulic tilt steering for motors over 150 hp
- Electric power assist steering (requires Sea Star upgrade)

### Bimini and Hard Top Options

- 8' x 10' Bimini top with boot
- Second Bimini top – factory pre-installed only (22' and up only)
- 12" aluminum hard top (factory installed only)

### Pontoon Options

- 23" to 25" upgrade
- Exclusive side protector keels

### Performance Options

- Waveglider™ high performance pontoons – see pages 14 and 15
- Sport Graphics Package see page 16
- Aluminum waveshield

### Watersports Options

- Ski tow bar

### Camper Enclosure Options – Factory Pre-installed Only

- 1/2 camper enclosure (22' and up only)
- 1/2 camper enclosure with bow cover

### Misc. Options

- Inflatable bow sleeper bed
- Stainless gas grill
- Wash down kit with sprayer and pump
- Seat covers in place of, or in addition to, mooring cover
- Colored wall skins – Black, Blue, Burgundy, and Champagne – Includes chrome dock light housings and custom matched graphics

### Docklines retractable built in

- Stainless steel non-skid strips for doorways
- Four eye straps to mount fenders
- Four stainless pop up cleats
- Logo soft cooler
- Portable cup holders

## 2010 SE-B FISH

## MORE PEOPLE THAT FISH CHOOSE TAHOE SE-B!

Only Tahoe gives you your choice of five fully loaded fishing models featuring livewells, comfortable fishing chairs, and a Garmin fishfinder graph. Most models include a built in tackle box, rod holders and a rod storage box too. With all of the different fishing layouts available in the SE-B, it should be easy to find the fishing set-up that's just right for your family.



SE-B Fish 24' RF

SE-B Fish 18' BF

SE-B Fish 22' RFC

SE-B Fish 22' FNC

SE-B Fish 20' FNF

## SPECIFICATIONS

LENGTH	18'	20'	22'	24'
Standard Pontoon Diameter	23"	23"	23"	23"
Standard Width	8'	8'	8'	8'
Dry Weight	1,600	1,750	2,000	2,200
Max Weight Cap.	1,575	1,805	2,000	2,210
Max Engine HP	75	90	100	130
Max # People	8	9	10	11
Max People Lbs.	1,070	1,250	1,450	1,530
Optional Width	8 1/2'	8 1/2'	8 1/2'	8 1/2'
Optional Pontoon Diameter	25"	25"	25"	25"
Dry Weight	1,650	1,800	2,050	2,250
Max Weight Cap.	1,870	2,130	2,350	2,600
Max Engine HP	90	115	125	150
Max # People	9	10	11	13
Max People Lbs.	1,270	1,380	1,600	1,850



Some models shown with optional equipment.

# Tahoe

PONTOON BOATS

## STANDARD FEATURES

### CASCADE AND SE-C FNF

#### Captain's Deluxe Polished Contoured Stand

- Level 2 helm package – platinum dash panel with lighted rocker switches
- Smoked glass side door, removable stand access panel
- Full gauge panel featuring black sterling tachometer, voltmeter
- MP3 player storage bin with smoked glass lid
- Surface storage tray for cell phone and other personal items
- Non-directional Huron steering wheel

#### Electronics

- Jensen high power MSR3007 CD stereo with MP3 plug
- Two Jensen high power speakers with platinum speaker covers
- 12 volt power point

#### Lighting

- Stainless courtesy light on side of Captain's stand
- USCG navigation and stern lighting

#### Furnishings

- Furnishings are created using exclusive MATRIX 50 marine upholstery
- Upholstered aluminum seat frames with flow through ventilation
- Plush designer furnishings
- Champagne perf accent vinyl
- Redesigned seat arms
- Custom Captain's chair

#### Styling

- Front radius walls
- Rear entry gate with swim platform rear entry ladder
- External wall skins with 29" high 1 1/4" diameter .090" anodized railings
- Hidden wall seams
- Non-skid strips for doorways
- Plush 20 oz. textured carpet
- Deluxe mural graphics package

#### Convenience

- Four stainless cleat and lifting eye assembly
- Oval table with cup holders

#### Canvas and Top

- 8' Bimini top with boot
- Transport position support brackets
- Bimini quick release pull pins

#### Construction

- 8' standard or optional 8 1/2" wide
- 23" standard or optional 25" diameter pontoons
- Heavy duty 3" reinforced deck rail
- Heavy duty C-channel crossbeams
- Corner castings all four corners
- Extra heavy duty motor pod double bolted with 3/8" SST bolts attached to seven crossbeams
- Gate latches with stainless steel insert and welded safety tab

#### STANDARD FEATURES ONLY ON SE-C FNF

- 24 gallon fuel system
- Fuel gauge
- Two front fishing stations with rod holder
- Two rear fishing stations with rod holder
- Side privacy station
- Large livewell over fuel tank

## INTERIOR OPTIONS

### CASCADE

#### REAR ENTRY

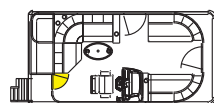

16'

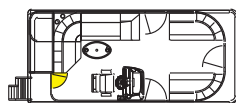

18'

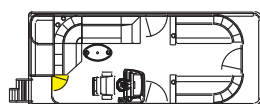

20'

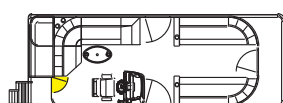

22'

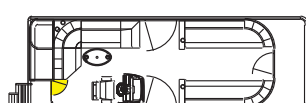

24'

### SE-C FNF

#### REAR ENTRY

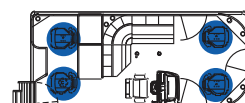

18'

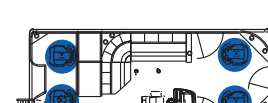

20'

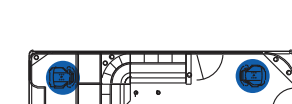

22'

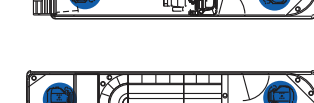

24'

## OPTIONS

### CASCADE AND SE-C FNF

#### 8.5' Wide Option – Includes:

- 25" diameter pontoons
- Plush 28 oz. Escalade carpet
- 8 1/2" x 10" Bimini top with boot

#### Deck Options

- Aluminum decking

#### Flooring Options

- Vinyl flooring (n/a on aluminum deck)
- Snap-in carpet (upgrade to vinyl flooring also required)
- Plush 28 oz. Escalade carpet
- Plush 28 oz. Islands carpet

#### Captain's Chair Options

- Exclusive Comfort-Plush™ high back reclining drivers Admiral's chair
- Exclusive Comfort-Plush™ low back reclining Commander's chair
- Double wide recliner Admiral's chair
- Plush fixed back Captain's chair with moveable arms and slide and swivel

#### Furniture Options

- Buckskin base vinyl (recommended only with colored wall skin)
- Smoked glass table with wine glass holders and stainless decorative cup holder
- Luxury umbrella with table (Tan only)
- Luxury umbrella (Tan only) with exclusive stylish round smoked glass table with wine glass holders and stainless decorative cup holder

#### Dash/Electronics Options

- Garmin 430S full color GPS (factory installed only) or (requires upgrade to level 3 dash)
- Garmin 440S full color coastal GPS (factory installed only) or (requires upgrade to level 3 dash)
- Fishfinder – Garmin (Model 145)
- Premium sound system upgrade (six coaxial speakers, subwoofer, amp.)

#### Jensen waterproof CD stereo MSR7007 exchange

- Jensen MSR2107 high power waterproof stereo with 1 GB storage and memory stick input (exchange)
- Extra Jensen speakers
- Marine Audio speakers
- Stainless logo speaker covers (requires M.A. speaker)
- Dual battery system with auto twin charge, start protect and low battery warning
- Battery selector switch
- Quick release windshield

#### Lighting Options

- Stainless amber floor mood lighting
- Engine compartment light
- Docking lights built into front walls (includes standard white docklight housings)
- Chrome housings for docklights on color wall skin

#### Steering Options

- Mechanical tilt steering
- Baystar hydraulic easy to turn tilt steering

#### Sea Star hydraulic steering for motors over 150 hp

- Electric power assist steering (requires Sea Star upgrade)

#### Bimini and Hard Top Options

- 8' x 10' Bimini top with logo boot
- Second Bimini top – factory pre-installed only
- 12' aluminum hard top (factory installed only)

#### Pontoon Options

- 23" to 25" upgrade
- Exclusive side protector keels
- Quick release windshield

#### Performance Options

- Waveglider™ high performance pontoons – see pages 14 and 15
- Sport Graphics Package – see page 16
- Aluminum waveshield

#### Watersports Options

- Ski tow bar
- Waterski/wakeboard tower – 8.5' wide only

#### Camper Enclosure Options – Factory Pre-installed Only

- 1/2 camper enclosure
- Full camper enclosure (22' and up only)
- 1/2 camper enclosure with bow cover

#### Entertaining Options

- Convenience center with Corian style surface, paper towel holder, and storage
- Stainless gas grill

#### Misc. Options

- Inflatable bow sleeper bed
- Livewell under port bow bench
- Wash down kit with sprayer and pump
- Seat covers
- Color matched full mooring cover
- Colored wall skins – Black, Blue, Burgundy, and Champagne – Includes custom matched graphics – docklights not included
- Chrome docklight housings

#### Docklines retractable built in

- Stainless steel non-skid strips for doorways
- Three dimensional deluxe raised logos
- Four eye straps to mount fenders
- Four stainless pop up cleats
- Logo soft cooler
- Portable cup holders
- Fire extinguisher

#### OPTIONS FOR CASCADE ONLY

#### PLEASE NOTE – 24 GALLON FUEL SYSTEM OPTIONAL ON CASCADE

- Six stainless steel easy to use twist lock Bimini quick connect (available only on 8 1/2' x 10' Bimini top)
- Standard walk-on sun roof (8' or 10') with ladder (ladder at front of roof except 8' on Elite models) upgrade to 25" pontoons required. Available factory installed only, 22' and up only
- Fuel gauge
- 24 gallon fuel system

## 2010 CASCADE

Even though Cascade is Tahoe's most affordable full size model, it sure doesn't look like it. A great way to start boating with high quality and less investment, the Cascade won't disappoint. Cascade is built with the same quality that goes into every Tahoe. Solid structure, plush MATRIX 50 seating, CD stereo and gauges provide the right amount of features for years of fun on the water.



Cascade 20' RE



Cascade 24' RD

Cascade 16' RE

Cascade 18' RE

Cascade 22' RE

Some models shown with optional equipment.

## 2010 SE-C FNF



SE-C FNF 20' RE

## SPECIFICATIONS

	Cascade		Cascade & SE-C FNF		
	16'	18'	20'	22'	24'
<b>LENGTH</b>	16'	18'	20'	22'	24'
<b>Standard Pontoon Diameter</b>	23"	23"	23"	23"	23"
Standard Width	8'	8'	8'	8'	8'
Dry Weight	1,350	1,600	1,750	2,000	2,200
Max Weight Cap.	1,380	1,575	1,805	2,000	2,210
Max Engine HP	50	75	90	100	130
Max # People	6	8	9	10	11
Max People Lbs.	950	1,070	1,250	1,450	1,530
<b>Optional Width</b>	8 1/2'	8 1/2'	8 1/2'	8 1/2'	8 1/2'
Optional Pontoon Diameter	25"	25"	25"	25"	25"
Dry Weight	1,425	1,650	1,800	2,050	2,250
Max Weight Cap.	1,580	1,870	2,130	2,350	2,600
Max Engine HP	60	90	115	125	150
Max # People	7	9	10	11	13
Max People Lbs.	1,050	1,270	1,380	1,600	1,850

**Tahoe**  
PONTON BOATS

Some models shown with optional equipment.

## STANDARD FEATURES

### Captain's Deluxe Polished Contoured Stand

- Level 1 helm package – brushed champagne dash panel lighted rocker switches
- Smoked glass side door, removable stand access panel
- MP3 player storage bin with smoked glass lid
- Non-directional Huron steering wheel

### Electronics

- 12 volt power point

### Lighting

- Stainless courtesy light on side of Captain's stand
- USCG navigation and stern lighting

### Furnishings

- Furnishings are created using exclusive MATRIX 50 marine upholstery.
- Upholstered aluminum seat frames with flow through ventilation
- Radius plush designer furnishings
- Champagne perf accent vinyl

### Styling

- Radius front walls
- External wall skins with 26" high 1 1/4" diameter .090" anodized railings
- Hidden wall seams
- Non-skid strips for doorways
- Plush 20 oz. textured carpet
- Mural graphics package

### Convenience

- Four stainless cleat and lifting eye assembly

### Canvas and Top

- 8' x 7' Bimini top with boot
- Bimini quick release pull pins

### Construction

- 7' wide
- 22" pontoons
- Heavy duty 3" reinforced deck rail
- Heavy duty C-channel crossbeams
- Corner castings all four corners
- Extra heavy duty motor pod double bolted with 3/8" SST bolts attached to seven crossbeams
- Gate latches with stainless steel insert and welded safety tab

## INTERIOR OPTIONS

### FAMILY

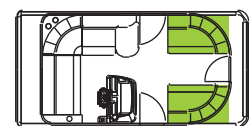

14'

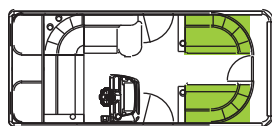

16'

### 16' OPTIONAL FAMILY RE

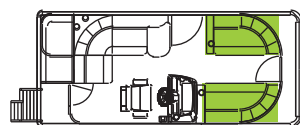

16'

### FISH

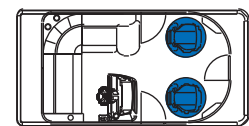

14'

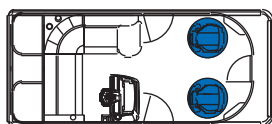

16'

## OPTIONS

### Deck Options

- Aluminum decking

### Flooring Options

- Vinyl flooring (n/a on aluminum deck)
- Snap-in carpet (upgrade to vinyl flooring also required)
- Plush 28 oz. Escalade carpet
- Plush 28 oz. Islands carpet

### Furniture Options

- Buckskin base vinyl (recommended only with colored wall skin)
- Oval table with cup holders
- Rear entry gate with ladder and custom Captain's chair (16' only)

### Dash/Electronics Options

- Tachometer, voltmeter, and fuel gauge
- Jensen high power MSR3007 CD stereo with MP3 plug
- Jensen high power speakers with platinum speaker covers
- Garmin 430S full color GPS (factory installed only) or (requires upgrade to level 3 dash)
- Garmin 440S full color coastal GPS (factory installed only) or (requires upgrade to level 3 dash)
- Fishfinder – Garmin (Model 145)
- Jensen waterproof CD stereo MSR7007 exchange
- Extra Jensen speakers
- Marine Audio speakers
- Stainless logo speaker covers (requires M.A. speaker)
- Dual battery system with auto twin charge and start protect
- Battery selector switch
- Fixed windshield

- Stainless amber floor mood lighting
- Docking lights built into front walls

### Steering Options

- Mechanical tilt steering

### Pontoon Options

- 22" to 23" upgrade
- Exclusive side protector keels

### Misc. Options

- Stainless rail mounted gas grill
- Livewell under port bow bench
- Wash down kit with sprayer and pump
- Color matched full mooring cover
- Seat covers
- Colored wall skins – Black, Blue, Burgundy, and Champagne – Includes custom matched graphics – docklights not included
- Chrome docklight housings
- Docklines retractable built in
- Stainless steel non-skid strips for doorways
- Three dimensional deluxe raised logos
- Four eye straps to mount fenders
- Four stainless pop up cleats
- Logo soft cooler
- Portable cup holders

## SPECIFICATIONS

LENGTH	14'	16'
Std. Pontoon Diameter	22"	22"
Width	7'	7'
Dry Weight	1,100	1,300
Max Weight Cap.	1,150	1,350
Max Engine HP	25	50
Max # People	5	6
Max People Lbs.	735	850
Optional Pontoon Diameter	23"	23"
Dry Weight	1,150	1,350
Max Weight Cap.	1,170	1,380
Max Engine HP	40	50
Max # People	5	6
Max People Lbs.	800	950

## 2010 SPORT

### AMERICAS BEST COMPACT PONTOON!

You can take the stylish Tahoe Sport anywhere. The 7' wide body is easy to trailer, requires only small gas horsepower and is perfect for electric outboards. The plush feel and classy radius look will have you looking smart in this economical pontoon boat.



Sport Fish 14'



Sport Fish 16'

Sport FAM 16' with optional RE



Sport FAM 14'



Sport FAM 16'

Some models shown with optional equipment.

**Tahoe**  
PONTOON BOATS



**Deck Options**

- 1 Aluminum decking

**Flooring Options**

- 2 28 oz. Escalade carpet
- 3 28 oz. Islands carpet
- 4 Vinyl flooring
- 5 Snap-in carpet (requires vinyl flooring)

**Captain's Chair Options**

- 6 Double wide recliner Admiral's chair
- 7 High back recliner Admiral's chair
- 8 Low back recliner Commander's chair
- 9 Captain's chair
- 10 Sport Graphics Package barrel chair

**Furniture Options**

- 11 Dinette in place of port bow bench (two Captain's chairs and oval table)
- 12 Umbrella table
- 13 Deluxe smoked glass wine table
- 14 Electric wine rack standard on Grand Tahoe
- 15 Admiral fiberglass entertainment helm
- 16 Commander entertainment center with stainless drawer, sink, and large capacity trash receptacle.
- 17 Convenience center with Corian style surface, storage and paper towel holder
- 18 Refrigerator – DC electric stainless steel with slide out top loading cooling compartment in special housing with Corian style surface, also shown with grill and mount
- 19 Trash can for lounge arm (Vista and Blue Ridge)

**Dash/Electronics Options**

- 20 Garmin 430S color GPS/depth gauge/fishfinder/inland maps (fits level 3 dash only)
- 21 Garmin 400C color depth gauge/fishfinder (fits level 2 dash only)
- 22 Garmin 145 depth gauge/fishfinder (fits level 3 dash only)
- 23 Jensen MSR7007 waterproof CD stereo
- 24 Mood lighting
- 25 Light for engine compartment (standard on Classic Series)



**Canvas and Top Options**

- 26 Second Bimini top (requires optional zippered connector for full length)
- 27 Standard walk-on sun roof (8' or 10', ladder at front, 25' pontoons required)
- 28 12' aluminum top
- 29 Half enclosure with bow cover
- 30 Full camper enclosure
- 31 1/2 camper enclosure
- 32 Seat covers

**Fishing Options**

- 33 Mooring cover
- 34 Rear deck option shown with additional teak option
- 35 Tahoe's exclusive easy access battery and electronics compartment (standard on Classic Series with rear sundeck)
- 36 Wash down kit with sprayer and pump

**Misc. Options**

- 37 Bow sleeper bed



CLASSIC SERIES			
Main	Accent	Pipe Trim	Carpet
BLUEONCE			
KRYPTONITE			
BLACK			
RED			
TOPAZ			
YELLOW			
BURGUNDY			
BROWN			
NAVY			
GREEN			

SE SERIES			
Main	Accent	Pipe Trim	Carpet
BLUEONCE			
KRYPTONITE			
BLACK			
RED			
TOPAZ			
YELLOW			
BURGUNDY			
BROWN			
NAVY			
GREEN			



**SOLID COLOR WALL SKINS**



# THE CERTIFIED ADVANTAGE

The NMMA Certified label on a Tahoe Pontoon boat lets you know it was built to meet and often exceed, the industry's strictest quality and safety standards for critical components such as electrical systems, powering, flotation, fuel systems, and navigation lights. Certified boats must also pass rigorous annual inspections from independent third-party inspectors. According to U.S. Coast Guard statistics NMMA Certified boats have been shown to be safer than non-certified boats.

**MATRIX-50**

*Tested Strongest*

Tahoe's exclusive MATRIX 50 heavy duty 50 gauge marine seat coverings with a 24% substructure is tested strongest against tears, punctures, and stains.



Dimensions, capacities, ratings and additional specifications plus complete warranty and service information are available from your Tahoe dealer. Product illustrations and data within this catalog are based upon information available at the time of publication. Tahoe reserves the right to make changes without notice or obligation. Ask your local Tahoe dealer for the most current product specifications prior to purchase. Some of the equipment shown separately or on products illustrated in this catalog may be optional at extra cost. All Tahoe boats meet or exceed the standards established by the ABYC and USCG flotation, fuel systems, ventilation, electrical, and safety.



**Tahoe**  
**PONTOON BOATS**

903 Michigan Avenue, Alma, Michigan 48801  
Worldwide: 800.334.2913 • 989.463.2112 • Fax: 989.463.8226

[www.tahoe pontoons.com](http://www.tahoe pontoons.com)



marine industry  
**CSI**  
award  
2009

Excellence in Customer Satisfaction

Tahoe's superior customer satisfaction  
is recognized by the NMMA  
**CSI AWARD** for 2008 and 2009!



Graphic design by  
The F.P. Horak Company

[www.fphorak.com](http://www.fphorak.com)

© 2010