

Tahoe 2011 Pontoon Boats

Tahoe 2011



PONTOON BOATS



Tahoe

# 2011 Tahoe

PONTOON BOATS

## LUXURY & STRENGTH.



Our total commitment to making the finest pontoon boats in the world has brought you the exciting Tahoe Pontoons. These luxurious boats are a beautiful composition of the finest elements known to pontoon boating, along with over 40 years of pontoon boat manufacturing experience. The finest construction, the most luxurious designs

and the largest group of unique standard features create a distinctly different and clearly superior pontoon boat that will exceed your expectations.

Tahoe is a vertically integrated builder. We manufacture the pontoons, framing, furniture, covers and more right in our own production facility using the latest computer driven equipment such as our Water Jet cutter, Gerber fabric cutter, Tiger saws and the latest in welding technology. As a result we are able to achieve and control the highest degree of quality.

Our number one investment, however, is our people. Tahoe's team of highly experienced welders, furniture makers and assemblers descend from generations of Midwestern craftsmen that have been instrumental in the building of America. Our headquarters based customer service people will make sure your experience is exceptional.

Tahoe is rated as having one of the lowest incidents of warranty claims in the industry and has also won the 2008, 2009 and 2010 NMMA CSI Award for outstanding customer service.



# SUPERIOR CONSTRUCTION

FIVE YEAR BOW TO STERN LIMITED WARRANTY PLUS LIMITED LIFETIME FLOORING, PONTOON WELD AND SEAT FRAME WARRANTY.



## TAHOE PONTOONS OFFERS THESE EXCLUSIVE HEAVY DUTY CONSTRUCTION FEATURES



- Tahoe's exclusive MATRIX 50 heavy duty 50 gauge marine seat covering with a 24% substructure is tested strongest against tears, punctures and stains.
- New Herringbone multi-directional stretch backing promotes quicker recovery.
- Greater stitch strength.

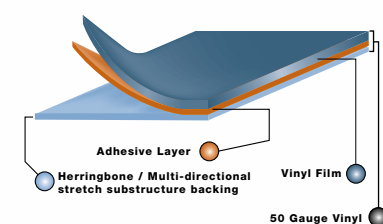

**Exclusive! Aluminum seat frames and kick panels**  
Clearly superior. Lifetime warranty. Aluminum seat frames are stronger, have extra large compartments for

maximum storage capacity and have "Flo thru™" ventilation from the outside. "Flo thru™" allows your equipment to dry out, even while the cover is on and keeps the entire compartment drier so mildew or fungus is less likely to develop. Aluminum frames won't crack or hold water like plastic, either!

**Heavy duty nose cone with our industry-first integrated nose cone splash fins!**  
The absolute strongest in the industry. The .100" thickness and one-piece

construction makes it virtually impossible to break off a splash fin. The double wrapped leading edge provides maximum impact protection.

**Stronger! Double full pontoon connectors**  
Most models feature full riser pontoon connections inside and outside. Unlike our competitor's "small but skirted" riser connectors. Full risers provide continuous strength along the entire pontoon.

**Exclusive! Deco Series side keel protection**  
Special welded keels protect against damage from side impact. They also provide better performance as they limit the flow of water around the pontoon.

**Interior drain**  
Tahoe now exclusively has a drain in the corner of the rear bench where water that would collect from rain during storage is expelled through a drain channel and off the boat. This significantly

reduces the potential for stains that develop in the corners over time.

**Double vented gas fill**  
Only Tahoe has solved the issue of fuel fill splash back and slowness. Tahoe's exclusive double fuel vent allows pressure to escape so you can fill quickly with almost no splash back.

**Reflective safety striping**  
Tahoe adds an additional level of night safety with striping that can be seen from a distance when exposed to light.

**Industry's strongest double bolted motor pod assembly**  
.190" thickness with integrated splash fins. 2" thick aluminum sheathed transom is fully welded. The entire pod is double bolted with at least 16 3/8" bolts and supported by more heavy-duty "C" channels crossbeams than any other pontoon boat.

**Superior quality pontoon tube**  
.090" thickness H5052 marine aluminum alloy. Multi-baffled near each weld for maximum

strength and air lock. Hand-welded to rigid standards.

**The best crossbeam and deck construction**  
Tahoe "Deco" Series pontoon boats feature the latest in heavy-duty hull construction. 3" high, extreme thickness "C" channel crossbeams are bolted to the full riser with heavy-duty stainless bolts, nuts and washers. Then 3/4", pressure injected, lifetime guaranteed flooring is bolted to the crossbeams using superior grade stainless steel bolts

secured permanently with stainless nylock lock nuts and washers.

**Strongest bow eye**  
Our standard equipment stainless bow eye is connected across three crossbeams with a 1/4" aluminum reinforcement strap. Excellent strength for haul-out.

**Wall joints**  
Wall joints welded on all four sides for extra strength.



2011  
**Tahoe**  
PONTOON BOATS



**TAHOE'S DECO SERIES**  
INNOVATION, STYLE, PERFORMANCE

**INTRODUCING PONTOON  
BOATING'S NEWEST TRENDSETTING STYLES!**

The fresh innovative Tahoe Deco Series designs feature stainless steel wall elements, stainless air vents, creative wall designs and a distinct Deco graphics package. All built on the industry's highest quality pontoon and deck construction.



2011



# VISION



Vision 27'



Vision 27'

## A RETRO DESIGN WITH ALL NEW 21ST CENTURY CONSTRUCTION!

VISION is the most revolutionary rear lounge model available. Featuring a whole new idea in wall construction that creates a seamless automotive style look. These remarkable heavy duty aluminum walls feature our exclusive Evolution™ high gloss marine quality coating, imbedded stainless steel designer accent wall grills and Deco graphics. Inside you will find the industry's only electric adjustable rear lounge seats that move to your most comfortable position at the touch of a button. Also included in the 27' model is a refrigerator, sink and electric hidden wine rack.



Some models shown with optional equipment.

## STANDARD FEATURES

### 25' Model – Commander Fiberglass Helm Stand Including:

- Level 5 dash package – high profile automotive style vinyl wrapped dash with woodgrain panels, lighted stainless toggle switches and windshield
- Lighted cup holder
- Full gauge panel featuring black sterling tachometer, voltmeter and fuel gauge
- MP3 player storage bin with smoked glass cover and plug
- Surface storage trays for cell phone and other personal items
- Seastar hydraulic easy-to-turn tilt steering
- Woodgrain steering wheel with brilliant aluminum non-directional spokes

### 27' Model – Admiral Fiberglass Entertainment Helm Including Above Items Plus:

- Faux Corian countertop with integrated sink, sink cover, electric faucet and two gallon water reservoir
- Electric hidden entertainment bar with wine racks, wine glasses and stainless cup holders that raises and lowers at the touch of a button
- Refrigerator – DC electric stainless steel with slide out top loading cooling compartment

- Stainless steel easy slide drawer system with friction lock

### Electronics

- Garmin full color GPS with built-in inland maps, Fishfinder, water temp, depth gauge, speedometer
- Jensen MSR2107 high power waterproof stereo with 1 GB storage and memory stick input. Includes four Marine Audio high power speakers and stainless logo speaker covers
- Two 12 volt power points – helm and bow
- Reserve battery system with Start Now protection

### Lighting

- SST docking lights built into front walls in heavy duty reinforced chrome housing
- Stainless amber floor mood lighting
- Lighted cup holders in rear lounges
- Bimini top light
- Stainless courtesy light on side of Admiral's stand
- USCG navigation and stern lighting

### Performance

- Waveglider™ high performance pontoons – includes 25" triple pontoons and Tahoe's exclusive Waveglider™ – high performance lifting strakes and 42 gallon fuel tank for center pontoon
- Ski tow bar

### Furnishings

- Plush Deco designer furnishings
- Plush dual rear reclining lounges with electric adjustable backs and plush pillows
- Plush bow bench lounge arms
- Exclusive Comfort-Plush™ high back reclining Admiral's chair with slide and swivel
- Furnishings are created using Tahoe's exclusive heavy duty 50 gauge Matrix 50 marine upholstery. Stain, tear and puncture resistant.
- Upholstered aluminum seat frames with dry floor matting and flow through ventilation
- Portable SST cup holders

### Styling

- Front radius deck with simulated teak flooring, rear deck with simulated teak flooring and twin ladders
- Exclusive Deco two tone ATI painted heavy duty solid aluminum walls
- SST retro grillwork integrated into bow and side walls
- SST front gate with smoked glass insert
- SST Deco side wall air vents
- SST non-skid strips for doorways
- Upholstered decorative interior wall covering

## INTERIOR OPTIONS

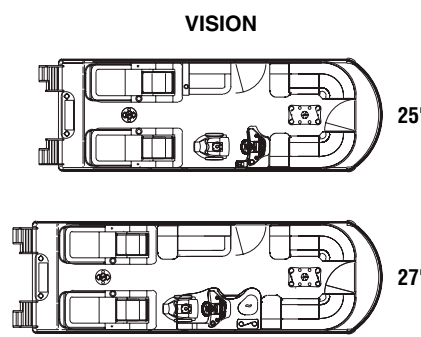

- HI Flex bold chrome logos
- Custom Art Deco graphics package
- Plush 28 oz. Islands designer carpet
- Convenience
  - Trash can built in
  - Exclusive stylish round smoked glass tables with wine glass holders and stainless decorative cup holders
  - Fire extinguisher
  - Four eye straps to mount fenders
  - Four stainless pop up cleats
  - SST gas cap and vent
  - Privacy station under rear lounge
- Canvas and Top
  - 10' Bimini top featuring round polished aluminum frame and logo boot
- Six stainless steel easy-to-use twist lock Bimini quick connect
- Transport position support brackets for Bimini top
- Color matched full mooring cover with vented pole supports
- Construction
  - 8 1/2" wide
  - Double full riser connections
  - Exclusive side protector keels
  - Heavy duty 4" reinforced deck rail with black rubber bumper
  - Heavy duty 3" C-channel crossbeams
  - Bolted deck with stainless bolts and lock nuts
  - Stainless steel corner castings all four corners
  - Extra heavy duty motor pod double bolted with 3/8" SST bolts

## OPTIONS

### Wall and Furniture Color Options

- See page 39

### Deck Options

- Aluminum decking

### Flooring Options

- Additional simulated teak flooring – see page 38
- Vinyl flooring (except rear and bow area) (n/a on aluminum deck)
- Snap-in carpet (except rear and bow area) (upgrade to vinyl flooring also required)

### Captain's Chair Options

- See pages 36 and 37

### Furniture Options

- Luxury umbrella (Tan only) for table (requires table with hole)

### Entertaining Options

- Stainless gas grill

### Dash/Electronics Options

- Garmin 441S Coastal GPS (upgrade exchange)
- Premium sound system upgrade (six coaxial speakers, subwoofer, amp.)
- Battery dual selector switch

### Lighting Options

- Rub rail multicolored light system
- Rear underwater lights

### Steering Options

- Electric power assist steering

### Bimini and Hard Top Options

- Second Bimini top – factory pre-installed only
- 12' aluminum hard top (factory installed only)

### Performance Options

- 27" center pontoon
- Aluminum Waveshield

### Watersports Options

- Waterski/wakeboard tower

### Camper Enclosure Options – Factory Pre-installed Only

- See page 36

### Misc. Options

- Livewell under port bow bench
- Wash down kit with sprayer and pump
- Seat covers in place of, or in addition to, mooring cover
- Docklines retractable built in

## SPECIFICATIONS

LENGTH	25'	27'
Pontoon Diameter	25" x 3	25" x 3
Width	8 1/2"	8 1/2"
Dry Weight	3,700	4,400
Max. Weight Cap.	2,930	2,910
Max. Engine HP	250	300
Max. # People	12	14
Max. People Lbs.	1,910	1,900



Some models shown with optional equipment.

Tahoe  
PONTOON BOATS

DECO  
SERIES

## STANDARD FEATURES

### 25' Model – Commander Fiberglass Helm Stand Including:

- Level 5 dash package – high profile automotive style vinyl wrapped dash with woodgrain panels, lighted stainless toggle switches and windshield
- Lighted cup holder
- Full gauge panel featuring black sterling tachometer, voltmeter and fuel gauge
- MP3 player storage bin with smoked glass cover and plug
- Surface storage trays for cell phone and other personal items
- Baystar hydraulic easy-to-turn tilt steering
- Woodgrain steering wheel with brilliant aluminum non-directional spokes

### 27' & 29' Models – Admiral Fiberglass Entertainment Helm Including Above Items Plus:

- Faux Corian countertop with integrated sink, sink cover, electric faucet and two gallon water reservoir
- Electric hidden entertainment bar with wine racks, wine glasses and stainless cup holders that raises and lowers at the touch of a button
- Refrigerator – DC electric stainless steel with slide out top loading cooling compartment
- Stainless steel easy slide drawer system with friction lock

### Electronics

- Garmin full color GPS with built-in inland maps, Fishfinder, water temp, depth gauge, speedometer
- Jensen MSR2107 high power waterproof stereo with 1 GB storage and memory stick input. Includes four Marine Audio high power speakers and stainless logo speaker covers
- Two 12 volt power points – helm and bow
- Reserve battery system with Start Now protection
- Exclusive fiberglass easy access dual battery box

### Lighting

- SST docking lights built into front walls in heavy duty reinforced chrome housing
- Stainless amber floor mood lighting
- Engine compartment light
- Bimini top light
- Stainless courtesy light on side of Admiral's stand
- USCG navigation and stern lighting

### Furnishings

- Plush Deco designer furnishings
- Plush bow bench lounge arms
- Plush pillowed arm rests port rear bench
- Hideaway flip down cup holders built into seat back
- Exclusive Comfort-Plush™ high back reclining Admiral's chair with slide and swivel

- Furnishings are created using Tahoe's exclusive heavy duty 50 gauge Matrix 50 marine upholstery. Stain, tear and puncture resistant.
- Upholstered aluminum seat frames with dry floor matting and flow through ventilation

### Styling

- Unique front and rear radius deck with simulated teak flooring
- Unique front and rear radius walls
- Rear entry with simulated teak floor and swim platform ladder
- SST rear entry gate with smoked glass insert
- SST integrated wall railings elements
- Exclusive Deco two tone wall panels with 29" high 1 1/4" diameter .090" anodized railings
- SST Deco side wall air vents
- HI Flex bold chrome logos
- Custom Art Deco graphics package
- Engraved interior door panels with net
- SST non-skid strips for doorways
- Upholstered decorative interior wall covering
- Plush 28 oz. Islands designer carpet

### Construction

- 8 1/2" wide
- 2 – 25" diameter pontoons
- Double full riser connections
- Exclusive side protector keels
- Heavy duty 4" reinforced deck rail with black rubber bumper
- Heavy duty 3" C-channel crossbeams
- Bolted deck with stainless bolts and lock nuts
- Stainless steel corner castings all four corners
- Extra heavy duty motor pod double bolted with 3/8" SST bolts

### Convenience

- Convenience center with Corian style surface, paper towel holder and storage

## INTERIOR OPTIONS

### REAR ENTRY

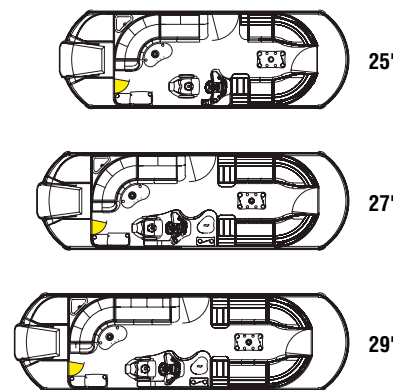

### ELITE

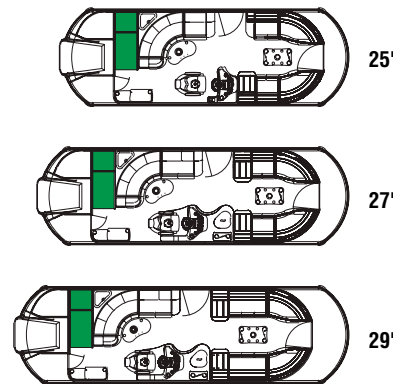

## SPECIFICATIONS

LENGTH	25'	27'	29'
Pontoon Diameter	25"	25"	25"
Width	8 1/2"	8 1/2"	8 1/2"
Dry Weight	2,450	2,650	2,850
Max. Weight Cap.	2,530	2,625	2,920
Max. Engine HP	150	175	200
Max. # People	13	14	16
Max. People Lbs.	1,790	2,030	2,270

- Seat covers in place of, or in addition to, mooring cover
- Docklines retractable built in
- Inboard/Outboard (standard only as a Waveglider™ model) see pages 20 and 21

## OPTIONS

### Wall and Furniture Color Options

- See page 39

### Deck Options

- Aluminum decking

### Flooring Options

- Additional simulated teak flooring – see page 38
- Vinyl flooring (except rear and bow area) (n/a on aluminum deck)
- Snap-in carpet (except rear and bow area) (upgrade to vinyl flooring also required)

### Captain's Chair Options

- See pages 36 and 37

### Furniture Options

- Luxury umbrella (Tan only) for table (requires table with hole)

### Entertaining Options

- Stainless gas grill

### Dash/Electronics Options

- Garmin 441S Coastal GPS (upgrade exchange)
- Premium sound system upgrade (six coaxial speakers, subwoofer, amp.)
- Battery dual selector switch

### Lighting Options

- Rub rail multicolored light system
- Rear underwater lights

### Steering Options

- Electric power assist steering (requires Sea Star upgrade)
- Sea Star hydraulic high capacity steering

### Bimini and Hard Top Options

- Second Bimini top – factory pre-installed only
- Standard walk-on sun roof (8' or 10') with ladder (ladder at front of roof except 8' on Elite models) available factory installed only
- 12' aluminum hard top (factory installed only)

### Performance Options

- Waveglider™ high performance pontoons – see pages 18 and 19
- Aluminum Waveshield

### Watersports Options

- Ski tow bar
- Waterski/wakeboard tower

### Camper Enclosure Options – Factory Pre-installed Only

- See page 36

### Misc. Options

- Livewell under port bow bench
- Wash down kit with sprayer and pump

# GRAND TAHOE CLASSIC

## GRAND TAHOE EXHIBITS QUALITY

The powerful, sporty GRAND TAHOE is the best exhibit of class in pontoon boating. With Deco styling that features stainless steel wall railing elements encompassing a fabulous, luxuriously appointed interior featuring designer furnishings, Grand Tahoe is the most exquisite pontoon boat available today. All this luxury and style is mounted on a foundation of the industry's strongest pontoon hull. All this and an almost endless list of standard features make Grand Tahoe one of the finest pontoon boats ever created.



Grand Tahoe 29' Elite

Grand Tahoe 27' Elite

Grand Tahoe 25' Elite

Some models shown with optional equipment.



DECO SERIES

## STANDARD FEATURES

**Commander Fiberglass Helm Including:**

- Level 5 dash package – high profile automotive style vinyl wrapped dash with woodgrain panels, lighted stainless toggle switches and windshield
- Lighted cup holder
- Full gauge panel featuring black sterling tachometer, voltmeter and fuel gauge
- MP3 player storage bin with smoked glass cover and plug
- Surface storage trays for cell phone and other personal items
- Baystar hydraulic easy-to-turn tilt steering
- Woodgrain steering wheel with brilliant aluminum non-directional spokes
- Smoked glass side door and storage with fuse panel

**Electronics**

- Garmin full color GPS with built-in inland maps, Fishfinder water temp, depth gauge, speedometer
- Jensen MSR2107 high power waterproof stereo with 1 GB storage and memory stick input. Includes four Marine Audio high power speakers and stainless logo speaker covers.

- Two 12 volt power points – helm and bow
- Exclusive fiberglass easy access dual battery box

**Lighting**

- SST docking lights built into front walls in heavy duty reinforced chrome housing
- Stainless amber floor mood lighting
- Engine compartment light
- Bimini top light
- Stainless courtesy light on side of Admiral's stand
- USCG navigation and stern lighting

**Furnishings**

- Plush radius designer furnishings
- Plush deluxe lounge arms
- Exclusive Comfort-Plush™ high back reclining Admiral's chair with slide and swivel
- Furnishings are created using Tahoe's exclusive heavy duty 50 gauge Matrix 50 marine upholstery. Stain, tear and puncture resistant.
- Upholstered aluminum seat frames with dry floor matting and flow through ventilation

- Portable SST cup holders

**Styling**

- SST front gate with smoked glass insert
- Rear entry with simulated teak floor and swim platform ladder
- SST rear entry gate with smoked glass insert
- Exclusive Deco two tone wall panels with 29" high 1 1/4" diameter .090" anodized railings
- SST Deco polished wall element
- SST Deco side wall air vents
- HI Flex bold chrome logos
- Custom Art Deco graphics package
- Engraved interior door panels with net
- Stainless steel non-skid strips for doorways
- Plush 28 oz. Islands carpet

**Convenience**

- Trash can built in
- Deluxe wine rack with ice carafe built in
- Exclusive stylish curved smoked glass table with wine glass holders and stainless decorative cup holders

- Fire extinguisher
- Four eye straps to mount fenders
- Four stainless pop up cleats
- 36 gallon fuel capacity with SST gas cap and vent

**Canvas and Top**

- 10' Bimini top featuring round polished aluminum frame and logo boot
- Six stainless steel easy-to-use twist lock Bimini quick connect
- Transport position support brackets for Bimini top
- Color matched full mooring cover with vented pole supports

**Construction**

- 8 1/2" wide
- 2 – 25" diameter pontoons
- Double full riser connections
- Exclusive side protector keels
- Heavy duty 4" reinforced deck rail with black rubber bumper
- Heavy duty 3" C-channel crossbeams
- Bolted deck with stainless bolts and lock nuts
- Stainless steel corner castings all four corners

- Extra heavy duty motor pod double bolted with 3/8" SST bolts

- Bow umbrella with exclusive round smoked glass cocktail table with wine glass holders
- Front fishing height radius walls

- Two bow commander reclining Comfort-Plush™ chairs

## INTERIOR OPTIONS

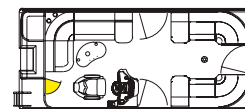
**SIERRA REAR ENTRY**

20'

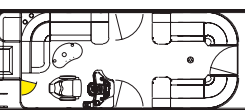

22'

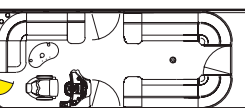

24'

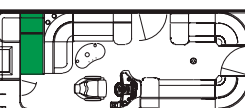
**SIERRA ELITE**

22'

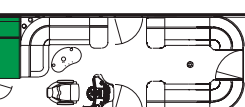

24'

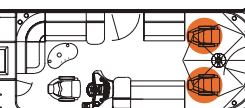
**SIERRA RC RE**

22'

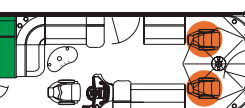
**SIERRA RC ELITE**

24'

## OPTIONS

**Wall and Furniture Color Options**

- See page 39

**Deck Options**

- Aluminum decking

**Flooring Options**

- Additional simulated teak flooring – see page 38
- Vinyl flooring (n/a on aluminum deck)
- Snap-in carpet (upgrade to vinyl flooring also required)

**Captain's Chair Options**

- See pages 36 and 37

**Entertaining Options**

- Refreshment center COMMANDER in place of lounge arm with sink, electric faucet, two gallon water reservoir, trash can liner and stainless drawer with ice cube cooler

- Refreshment center CAPTAIN in place of lounge arm with sink, electric faucet, two gallon water reservoir, trash can liner and smoked glass style door

- Convenience center with Corian style surface, paper towel holder and storage (Elite interior only)

- Refrigerator – DC electric stainless steel with slide out top loading cooling compartment in special housing with Corian style surface

**Dash/Electronics Options**

- Garmin 441S Coastal GPS (upgrade exchange)
- Premium sound system upgrade (six coaxial speakers, subwoofer, amp.)
- Reserve battery system with Start Now protection

- Battery dual selector switch
- Premium sound system

**Steering Options**

- Electric power assist steering (requires Sea Star upgrade)
- Sea Star hydraulic high capacity steering

**Bimini and Hard Top Options**

- Second Bimini top – factory pre-installed only
- Standard walk-on sun roof (8' or 10') with ladder (ladder at front of roof except 8' on Elite models) available factory installed only
- 12' aluminum hard top (factory installed only)

**Performance Options**

- Waveglider™ high performance pontoons – see pages 18 and 19
- Aluminum Waveshield

**Watersports Options**

- Ski tow bar
- Waterski/wakeboard tower

**Camper Enclosure Options – Factory Pre-installed Only**

- See page 36

**Misc. Options**

- Livewell under port bow bench
- Wash down kit with sprayer and pump
- Seat covers in place of, or in addition to, mooring cover
- Docklines retractable built in
- Front radius deck
- Inboard/Outboard (standard only as a Waveglider™ model) see pages 20 and 21

**Sierra Additional Options**

- Luxury umbrella (Tan only) with round smoked glass table



Sierra RC 22' RE

## IT JUST KEEPS GETTING BETTER

A legend in top of the line, luxury pontoon boats with all new deco flair! Tahoe's SIERRA & SIERRA RC are praised for their magnificent blend of form and function. The industry's strongest pontoon hull is the foundation for the retro styling and plush furnishings made with Tahoe's exclusive Matrix 50 seat coverings. Tahoe's custom designed "Comfort-Plush" reclining Admiral's chair, a Garmin color GPS and a classy wine rack are just a few of the other amenities.



Sierra 20' RE



Sierra 22' Elite

## SPECIFICATIONS

	Sierra	Sierra & Sierra RC
<b>LENGTH</b>	20'	22' 24'
Pontoon Diameter	25"	25" 25"
Width	8 1/2'	8 1/2' 8 1/2'
Dry Weight	1,800	2,050 2,250
Max. Weight Cap.	2,130	2,260 2,600
Max. Engine HP	115	125 150
Max. # People	10	11 13
Max. People Lbs.	1,380	1,600 1,850

Some models shown with optional equipment.

## STANDARD FEATURES

**Commander Fiberglass Helm Including:**

- Level 5 dash package – high profile automotive style vinyl wrapped dash with woodgrain panels, lighted stainless toggle switches and windshield
- Lighted cup holder
- Full gauge panel featuring black sterling tachometer, voltmeter and fuel gauge
- MP3 player storage bin with smoked glass cover and plug
- Surface storage trays for cell phone and other personal items
- Sea Star hydraulic easy-to-turn tilt steering
- Woodgrain steering wheel with brilliant aluminum non-directional spokes
- Smoked glass side door and storage with fuse panel

**Electronics**

- Garmin full color GPS with built-in inland maps, Fishfinder water temp, depth gauge, speedometer
- Jensen MSR2107 high power waterproof stereo with 1 GB storage and memory stick input. Includes four Marine Audio high power speakers and stainless logo speaker covers.
- Two 12 volt power points – helm and bow

- Reserve battery system with Start Now protection

**Lighting**

- SST docking lights built into front walls in heavy duty reinforced chrome housing
- Stainless amber floor mood lighting
- Bimini top light
- Stainless courtesy light on side of Admiral's stand
- USCG navigation and stern lighting

**Performance**

- Waveglider™ system – high performance pontoons – includes 25" triple pontoons and Tahoe's exclusive Waveglider™ – high performance lifting strakes and 42 gallon fuel tank for center pontoon
- Ski tow bar

**Furnishings**

- Plush radius designer furnishings
- Plush deluxe lounge arms
- Exclusive Comfort-Plush™ high back reclining Admiral's chair with slide and swivel
- Starboard radius bow bench
- Port bow dinette with Commander low back recliners

- Umbrella with exclusive stylish round smoked glass table with wine glass holders and stainless decorative cup holder
- Port side bench
- Port privacy station
- Furnishings are created using Tahoe's exclusive heavy duty 50 gauge Matrix 50 marine upholstery. Stain, tear and puncture resistant.
- Upholstered aluminum seat frames with dry floor matting and flow through ventilation

- Portable SST cup holders

**Entertainment Areas**

- Culinary center including: Refrigerator – DC electric stainless steel with slide out top loading cooling compartment in special housing with Corian style surface
- Stainless steel gas grill
- Refreshment center COMMANDER with sink, electric SST faucet, two gallon water reservoir, trash can liner and stainless drawer
- Large rear swim platform area with simulated teak non-skid flooring

- One port and one starboard rear swim platform ladder
- Rear bar and music center includes cup holders, remote stereo controls, 12 volt outlet, storage and cube cooler
- Two rear Sandbar recliner chairs with footrest
- Exclusive stylish round smoked glass cocktail table with wine glass holders and stainless decorative cup holder
- Telescoping flag pole with American flag

**Styling**

- Front radius walls
- SST front gate with smoked glass insert
- Exclusive Deco two tone wall panels with 29" high 1 1/4" diameter .090" anodized railings SST Deco polished wall element
- SST Deco side wall air vents
- HI Flex bold chrome logos
- Custom Art Deco graphics package
- Engraved interior door panels with net
- Stainless steel non-skid strips for doorways

- Plush 28 oz. Islands carpet

**Convenience**

- Fire extinguisher
- Four eye straps to mount fenders
- Four stainless pop up cleats

**Canvas and Top**

- 10' Bimini top featuring round polished aluminum frame and logo boot
- Six stainless steel easy to twist lock Bimini quick connect
- Transport position support brackets for Bimini top
- Color matched full mooring cover with vented pole supports

**Construction**

- 8 1/2' wide
- Double full riser connections
- Exclusive side protector keels
- Heavy duty 4" reinforced deck rail with black rubber bumper
- Heavy duty 3" C-channel crossbeams
- Bolted deck with stainless bolts and lock nuts
- Stainless steel corner castings all four corners
- Extra heavy duty motor pod integrated into center pontoon

## RAISE YOUR FLAG!

TAHOE'S SANDBAR model is the ultimate party platform. Park at your favorite beach or sandbar and use the entire boat from end to end for swimming, partying, listening to tunes, lounging and enjoying refreshments. When you're done with that, crank her up and charge across the water on the standard Waveglider™ high performance pontoons for skiing, tubing or just enjoying the warm breeze.

ATI heavy duty aluminum walls available as an option on Paradise Sandbar.



## SIERRA SANDBAR



Sierra Sandbar 26' ATI

Sierra Sandbar 26'

## OPTIONS

**Wall and Furniture Color Options**

- See page 39

**Deck Options**

- Aluminum decking

**Flooring Options**

- Additional simulated teak flooring – see page 38
- Vinyl flooring (n/a on aluminum deck)
- Snap-in carpet (upgrade to vinyl flooring also required)

**Captain's Chair Options**

- See pages 36 and 37

**Dash/Electronics Options**

- Garmin 441S Coastal GPS (upgrade exchange)
- Premium sound system upgrade (six coaxial speakers, subwoofer, amp.)
- Battery dual selector switch

**Steering Options**

- Electric power assist steering

**Bimini and Hard Top Options**

- Second Bimini top – factory pre-installed only
- Standard walk-on sun roof (8' or 10') with ladder (ladder at front of roof except 8' on Elite models) available factory installed only
- 12' aluminum hard top (factory installed only)

**Performance Options**

- Aluminum Waveshield

**Watersports Options**

- Waterski/wakeboard tower

**Camper Enclosure Options – Factory Pre-installed Only**

- See page 36

**Misc. Options**

- Livewell under port bow bench
- Wash down kit with sprayer and pump
- Seat covers in place of, or in addition to, mooring cover
- Docklines retractable built in
- Front radius deck
- Inboard/Outboard (standard only as a Waveglider™ model) see pages 20 and 21

## INTERIOR OPTIONS

## SIERRA SANDBAR

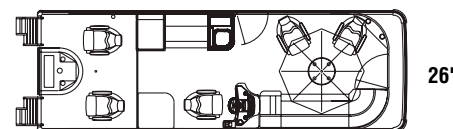

## SPECIFICATIONS

PONTOON LENGTH	26'
Pontoon Diameter	25" x 3
Width	8 1/2'
Dry. Weight	3,125
Max Weight Cap.	3,200
Max. Engine HP	300
Max. # People	17
Or Max. Persons Lbs.	2,400



Some models shown with optional equipment.

Tahoe  
PONTOON BOATS

DECO  
SERIES



## STANDARD FEATURES

**Commander Fiberglass Helm Including:**

- Level 5 dash package – high profile automotive style vinyl wrapped dash with woodgrain panels, lighted stainless toggle switches and windshield
- Lighted cup holder
- Full gauge panel featuring black sterling tachometer, voltmeter and fuel gauge
- MP3 player storage bin with smoked glass cover and plug
- Surface storage trays for cell phone and other personal items
- Sea Star hydraulic easy-to-turn tilt steering
- Woodgrain steering wheel with brilliant aluminum non-directional spokes
- Smoked glass side door and storage with fuse panel

**Electronics**

- Garmin full color GPS with built-in inland maps, Fishfinder water temp, depth gauge, speedometer
- Jensen MSR2107 high power waterproof stereo with 1 GB storage and memory stick input. Includes four Marine Audio high power speakers and stainless logo speaker covers.

- Two 12 volt power points – helm and bow
- Reserve battery system with Start Now protection
- Exclusive fiberglass easy access dual battery box

**Lighting**

- Docking lights built into front walls in heavy duty reinforced housing
- Stainless amber floor mood lighting
- Engine compartment light
- Bimini top light
- Stainless courtesy light on side of Admiral's stand
- USCG navigation and stern lighting

**Performance**

- Waveglider™ system – high performance pontoons – includes 25" triple pontoons and Tahoe's exclusive Waveglider™ – high performance lifting strakes and 42 gallon fuel tank for center pontoon
- Ski tow bar

**Furnishings**

- Plush radius designer furnishings
- Plush deluxe lounge arms
- Exclusive Comfort-Plush™ high back reclining Admiral's chair with slide and swivel

- Furnishings are created using Tahoe's exclusive heavy duty 50 gauge Matrix 50 marine upholstery. Stain, tear and puncture resistant.
- Upholstered aluminum seat frames with dry floor matting and flow through ventilation
- Portable SST cup holders

**Funship Special Equipment**

- Deluxe 10' walk-on sun roof with rear ladder, Waterpark™ slide with waterfall water pump, decorative walls, king size upper deck lounge with backs and cushions, upper deck entertainment center with remote, stereo controls, two speakers and storage
- Convenience center starboard rear with Corian style surface, paper towel holder and storage

**Styling**

- Front radius walls
- SST front gate with smoked glass insert
- Rear entry with simulated teak floor and swim platform ladder
- SST rear entry gate with smoked glass insert
- Exclusive Deco two tone wall panels with 29" high 1 1/4" diameter .090" anodized railings

- SST Deco polished wall element
- SST Deco side wall air vents
- HI Flex bold chrome logos
- Custom Art Deco graphics package
- Engraved interior door panels with net
- Stainless steel non-skid strips for doorways
- Plush 28 oz. Islands carpet

**Convenience**

- Trash can built in
- Deluxe wine rack with ice carafe built in
- Exclusive stylish curved smoked glass table with wine glass holder sand stainless decorative cup holders
- Fire extinguisher

- Four eye straps to mount fenders
- Four stainless pop up cleats

**Canvas**

- Color matched full mooring cover with vented pole supports

**Construction**

- 8 1/2' wide
- Double full riser connections
- Exclusive side protector keels
- Heavy duty 4" reinforced deck rail with black rubber bumper
- Heavy duty 3" C-channel crossbeams
- Bolted deck with stainless bolts and lock nuts
- Stainless steel corner castings all four corners

## INTERIOR OPTIONS

## SIERRA FUNSHIP

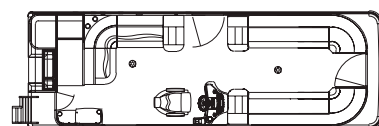

26'

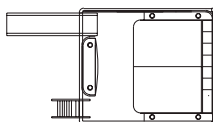

## SPECIFICATIONS

PONTOON LENGTH	26'
Pontoon Diameter	25' x 3
Width	8 1/2'
Dry Weight	3,850
Max. Wt. Cap.	2,990
Max. Engine HP	250
Max. No. People	16
Max. People Lbs.	2,190

**Misc. Options**

- Liveswell under port bow bench
- Wash down kit with sprayer and pump
- Seat covers in place of, or in addition to mooring cover

- Docklines retractable built in
- Front radius deck
- Inboard/Outboard (standard only as a Waveglider™ model) see pages 20 and 21

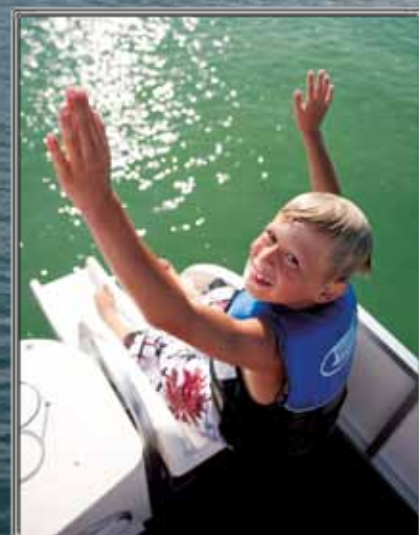

# SIERRA FUNSHIP

Sierra Funship 26'



## A WATER PARK ON THE WATER!

Have the best of family fun every weekend with the all new SIERRA FUNSHIP. Loaded with standard features to make a day on the water complete. Slide, swim, lounge, entertain and even water-ski with the standard triple Waveglider™ high performance pontoons. Do it all—and do it all at once—on the Funship!

# Tahoe

PONTOON BOATS

Some models shown with optional equipment.



DECO  
SERIES

# 2011 Tahoe PONTON BOATS

# WAVEGLIDER™ HIGH PERFORMANCE PACKAGES



WAVEGLIDER™ SPECIFICATIONS									
Boat Size	Pontoon Length	Pontoon Diameter	Deck Width	Dry Weight	Maximum Weight Capacity	Maximum Engine	Maximum Number Persons	Maximum Persons Weight	
<b>DECO SERIES</b>									
<b>VISION</b>									
27'	26'	3-25"	8.5'	4,400	2,910	300	14	1,900	
25'	24'	3-25"	8.5'	3,700	2,930	250	12	1,910	
<b>GRAND TAHOE</b>									
29'	28'	3-25"	8.5'	3,500	3,415	300	19	2,645	
27'	26'	3-25"	8.5'	3,300	3,200	300	17	2,350	
25'	24'	3-25"	8.5'	3,100	2,910	250	15	2,050	
<b>SIERRA</b>									
24'	24'	3-25"	8.5'	3,000	2,850	250	15	2,080	
22'	22'	3-25"	8.5'	2,800	2,650	225	12	1,780	
20'	20'	3-25"	8.5'	2,200	2,460	175	12	1,720	
<b>SIERRA RC</b>									
24'	24'	3-25"	8.5'	3,000	2,940	250	15	2,080	
22'	22'	3-25"	8.5'	2,800	2,650	225	12	1,780	
<b>SIERRA SANDBAR</b>									
26'	26'	3-25"	8.5'	3,125	3,200	300	17	2,400	
<b>SIERRA FUNSHIP</b>									
26'	26'	3-25"	8.5'	3,850	2,990	250	16	2,190	
<b>C SERIES</b>									
<b>VISTA CTS 25" DIAMETER</b>									
24'	24'	3-25"	8.5'	3,000	2,850	250	15	2,080	
22'	22'	3-25"	8.5'	2,800	2,650	225	12	1,780	
20'	20'	3-25"	8.5'	2,200	2,460	150	12	1,720	
18'	18'	3-25"	8.5'	1,950	2,100	115	10	1,440	
<b>VISTA RC</b>									
24'	24'	3-25"	8.5'	3,000	2,850	250	15	2,080	
22'	22'	3-25"	8.5'	2,800	2,650	225	12	1,780	
<b>VISTA SANDBAR CTS</b>									
26'	26'	3-25"	8.5'	3,125	3,200	300	17	2,400	
<b>VISTA FUNSHIP</b>									
26'	26'	3-25"	8.5'	3,850	2,990	250	16	2,190	
24'	24'	3-25"	8.5'	3,750	2,665	225	14	1,910	
<b>BLUE RIDGE</b>									
24'	24'	3-25"	8.5'	3,000	2,850	250	15	2,080	
22'	22'	3-25"	8.5'	2,800	2,650	225	12	1,780	
<b>SE-B FISH</b>									
24'	24'	3-25"	8.5'	3,000	2,850	250	15	2,080	
22'	22'	3-25"	8.5'	2,800	2,650	225	12	1,780	
20'	20'	3-25"	8.5'	2,200	2,460	150	12	1,720	
18'	18'	3-25"	8.5'	1,950	2,100	115	10	1,440	
<b>A SERIES</b>									
<b>CASCADE 23" DIAMETER</b>									
24'	24'	3-23"	8'	2,800	2,520	200	13	1,810	
22'	22'	3-23"	8'	2,600	2,265	150	11	1,560	
20'	20'	3-23"	8'	2,080	2,150	135	10	1,400	
18'	18'	3-23"	8'	1,875	1,890	100	9	1,290	
16'	16'	3-23"	8'	1,600	1,650	75	8	1,100	
<b>CASCADE 25" DIAMETER</b>									
24'	24'	3-25"	8.5'	3,000	2,850	250	15	2,080	
22'	22'	3-25"	8.5'	2,800	2,650	225	12	1,780	
20'	20'	3-25"	8.5'	2,200	2,460	175	12	1,720	
18'	18'	3-25"	8.5'	1,950	2,100	115	10	1,440	
<b>SE-C FNF 23" DIAMETER</b>									
24'	24'	3-23"	8'	2,800	2,520	200	13	1,810	
22'	22'	3-23"	8'	2,600	2,265	150	11	1,560	
20'	20'	3-23"	8'	2,080	2,150	135	10	1,400	
18'	18'	3-23"	8'	1,875	1,890	100	9	1,290	
<b>SE-C FNF 25" DIAMETER</b>									
24'	24'	3-25"	8'	2,800	2,520	200	13	1,810	
22'	22'	3-25"	8'	2,600	2,265	150	11	1,560	
20'	20'	3-25"	8'	2,080	2,150	135	10	1,400	
18'	18'	3-25"	8'	1,875	1,890	100	9	1,290	
16'	16'	3-25"	8'	1,700	1,860	90	9	1,300	
<b>SPORT</b>									
16'	16'	3-23"	7'	1,600	1,650	75	8	1,100	
14'	14'	3-23"	7'	1,400	1,360	60	6	840	

## WAVEGLIDER™ HIGH PERFORMANCE SYSTEM PROVEN PERFORMANCE AND DURABILITY!

Tahoe has tested our High Performance System on trips from Baltimore to Key West, across Lake Michigan and across the ocean from Ft. Lauderdale to Bimini in the Bahamas, and Key West to the Dry Tortugas. So you can be assured of one tough, high performance boat. So go ahead and turn your boat into the fast planing sport boat you want. It will be a blast to drive, a great all around family boat and perfect for pulling skiers, tubes and wakeboards.\*



Waveglider™ High Performance System – 23" or 25" diameter triple pontoons, high performance lifting strakes, Sea Star hydraulic steering and 42 gallon fuel tank for center pontoon.



Waveglider™ with aluminum wavelshield



Some models shown with optional equipment.



## WAVEGLIDER™ WATERSPORTS PACKAGE

Waveglider™ Watersports package includes Waveglider™ High Performance System – plus: ski tow bar and aluminum wavelshield.



## WAVEGLIDER™ 5X7 TURNING PACKAGE

Take it to the next level by equipping your craft with the Tahoe Waveglider™ 5X7 High Performance Turning Package. For O/B models it includes the Waveglider™ Watersports package with 25" outside pontoons PLUS an upgrade to a 27" diameter Waveglider™ center pontoon and electric power assist steering for sharper turns!

Just add a 27" center pontoon on an I/O to go 5X7!

*Note – 5X7 package is not available on Funship models or any model with a walk-on sunroof.*



**OPTIONAL SPORT GRAPHICS PACKAGE! C & A SERIES ONLY**

- **Yellow Fire** – Fire Graphics, yellow interior with black accent, yellow dash, steering wheel and yellow accent sport barrel chair with bolster and stainless steel speaker covers.
- **Red Fire** – Fire Graphics, red interior with black accent, red dash, steering wheel and red accent sport barrel chair with bolster and stainless steel speaker covers.
- **Black Fire** – For black wall skin boats – Fire Graphics, black interior with tan accent, carbon fiber dash, steering wheel and black accent sport barrel chair with bolster and stainless steel speaker covers.



Some models shown with optional equipment.



2011  
**Tahoe**  
PONTOON BOATS

I/O Mercruiser – Deco Series only includes: standard 350 MAG MPI 300 HP Sterndrive with Bravo III outdrive, twin stainless steel propellers, Corsa Captain's choice exhaust, Waveglider™ High Performance System 25" dia. triple pontoons, high performance lifting strakes, Sea Star hydraulic steering and 42 gallon fuel tank for center pontoon, power assist steering, ski tow bar I/O, bilge pump, additional oil and temp gauge, exhaust blower and aluminum waveshield.

**INBOARD/OUTBOARD FEATURES**

**BRAVO 3 DUAL PROP OUTDRIVE**



**CORSA THROUGH HULL EXHAUST**



**POWER ASSIST STEERING**



**ALUMINUM WAVESHIELD**



**OPTIONAL INBOARD/OUTBOARD FIBERGLASS FULL WIDTH REAR SWIM PLATFORM**

Some models shown with optional equipment.

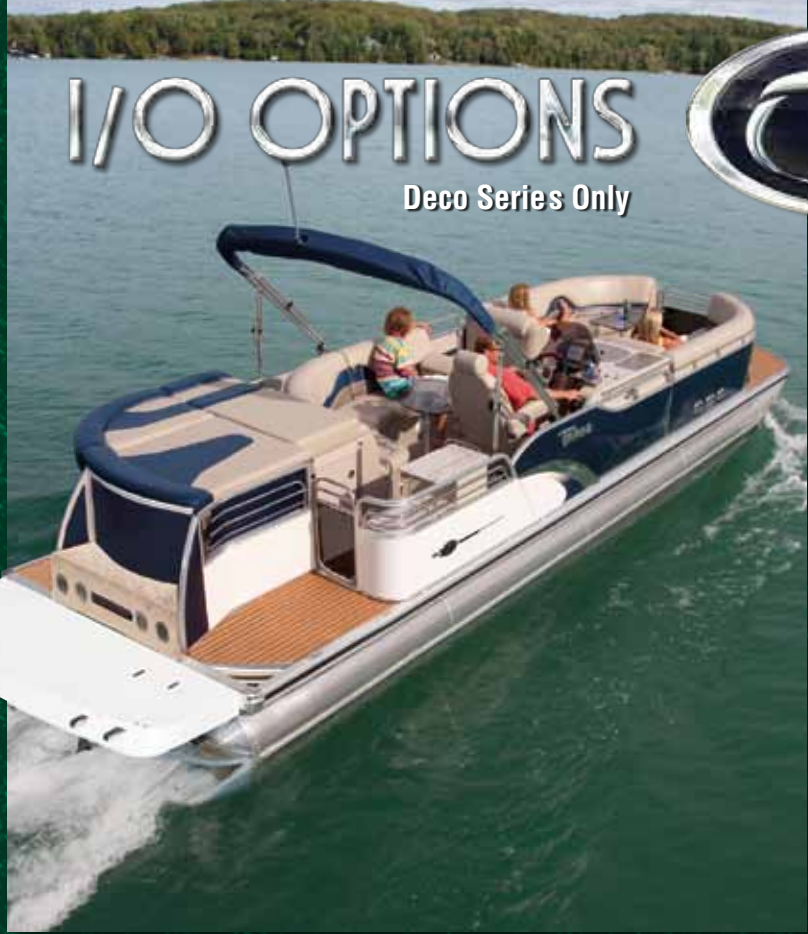

**I/O OPTIONS**

Deco Series Only



**WATERSPORT & PERFORMANCE OPTIONS**

**PERFORMANCE OPTIONS**

**ROUGH WATER PACKAGE** (factory installed only for Waveglider and 5 X 7) – suggested when boat is going to be consistently exposed to very rough water. Adds extra welding and extreme duty riser components

**ALUMINUM WAVESHIELD** (factory installed only) – prevents water from hitting crossbeams and under side of deck while underway

**WATERSPORTS OPTIONS**

**SKI TOW BAR** – allows convenient towing for skiers and tubes

**WATERSKI/WAKEBOARD TOWER** – 8.5' wide only (Includes SS Bimini top) provides preferred elevation of the ski pylon for wakeboarders and advanced skiers.\*

**TOWER OPTIONS**

- High power speakers with microphone
- Spotlight
- Tower racks (four pieces – two sides)

**IN FLOOR STORAGE COMPARTMENT**

– factory installed only in center pontoon models



**POWER ASSIST STEERING**

– Add power assist steering to give your boat even better handling and turning capability – requires upgrade to Sea Star Hydraulic steering



*High performance options are available factory installed only!*



\*Please follow all safety rules when towing watersports equipment. Do not overload ski tow bar or Waterski/wakeboard tower.



## STANDARD FEATURES

### Helmsman Fiberglass Stand

- Level 3 helm package – automotive style vinyl wrapped dash with woodgrain panels, lighted stainless toggle switches, quick release windshield, smoked glass side door, 25 qt. cooler, removable stand access panel and glove box
- Full gauge panel featuring black sterling tachometer, voltmeter and fuel gauge
- Surface storage trays for cell phone and other personal items
- Woodgrain tilt steering wheel with brilliant aluminum non-directional spokes

### Electronics

- Jensen high power MSR3007 CD stereo with MP3 plug
- Two Jensen high power speakers with platinum speaker covers
- 12 volt power point

### Lighting

- Docking lights built into front walls in heavy duty reinforced housing
- Stainless courtesy light on side of Captain's stand
- USCG navigation and stern lighting

### Furnishings

- Furnishings are created using exclusive Matrix 50 marine upholstery
- Upholstered aluminum seat frames with dry floor matting and flow through ventilation
- Pleated plush radius designer furnishings
- Plush deluxe lounge arms
- Captain plush fixed back driver's chair with arms
- Portable cup holders

### Styling

- Front radius wall railings
- Rear entry gate with swim platform rear entry ladder

- External wall skins with .29" high 1 1/4" diameter .090" anodized railings

- Hidden wall seams
- Non-skid strips for doorways
- Plush 28 oz. Escalade Hi-Lo carpet
- Deluxe graphics package
- Three dimensional raised logos

### Convenience

- Fire extinguisher
- Four stainless cleat and lifting eye assembly
- 24 gallon fuel capacity
- Thermoform curved table with locking floor base
- Latched door for privacy station on Elite models

### Canvas and Top

- 10' Bimini top with boot
- Transport position support brackets
- Bimini quick release pull pins

## INTERIOR OPTIONS

### VISTA REAR ENTRY

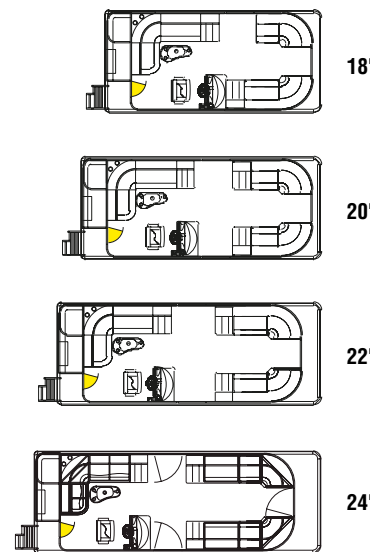

### VISTA ELITE

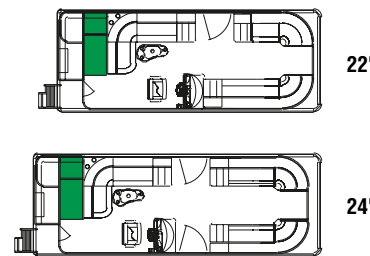

- Color matched full mooring cover with vented pole supports

### Construction

- 8 1/2" wide
- Two - 25" diameter pontoons
- Double full riser connections
- Heavy duty 3" reinforced deck rail
- Heavy duty C-channel crossbeams
- 16" OC crossbeam spacing
- Corner castings all four corners
- Extra heavy duty motor pod double bolted with 3/8" SST bolts attached to seven crossbeams
- Gate latches with stainless steel insert and welded safety tab

### Performance Options

- Waveglider™ high performance pontoons – see pages 18 and 19
- Aluminum Waveshield

### Watersports Options

- Ski tow bar
- Waterski/wakeboard tower

### Camper Enclosure Options – Factory Pre-installed Only

- See page 36

### Misc. Options

- Livewell under port bow bench
- Docklines retractable built in
- Trash can built into lounge arm
- Wine rack built in to lounge arm

### Lighting Options

- Stainless amber floor mood lighting
- Engine compartment light

### Steering Options

- Baystar hydraulic easy-to-turn tilt steering
- Sea Star hydraulic steering for motors over 150 hp
- Electric power assist steering (requires Sea Star upgrade)

### Bimini and Hard Top Options

- Six stainless steel easy to use twist lock Bimini quick connect (available only on 8 1/2' x 10' Bimini top)
- Second Bimini top – factory pre-installed only
- Standard walk-on sun roof (8' or 10') with ladder (ladder at front of roof except 8' on Elite models). Upgrade to 25' pontoons required. Available factory installed only, 22' and up only.
- 12' aluminum hard top (factory installed only) Pontoon Options
- Exclusive side protector keels

## SPECIFICATIONS

LENGTH	18'	20'	22'	24'
Pontoon Diameter	25"	25"	25"	25"
Width	8 1/2'	8 1/2'	8 1/2'	8 1/2'
Dry Weight	1,650	1,800	2,050	2,250
Max. Weight Cap.	1,870	2,130	2,350	2,600
Max. Engine HP	90	115	125	150
Max. # People	9	10	11	13
Max. People Lbs.	1,270	1,380	1,600	1,850



Vista 22' Elite



Vista 24' Elite



Vista 20' RE



Vista 18' RE

## BEAUTIFUL & LUXURIOUS BEST DESCRIBES THE TAHOE VISTA.

It is the smart choice for families looking for an affordable luxury pontoon. Standard features include heavy-duty construction, 16" on-center crossbeams, plush custom-designed furnishings with soft lounge arms, a CD player, a great Captain's chair, ladder, tilt steering, built-in dock lights and a mooring cover. And all for a fantastic price.

**Tahoe**  
PONTOON BOATS

## STANDARD FEATURES

### Helmsman Fiberglass Stand

- Level 3 helm package – automotive style vinyl wrapped dash with woodgrain panels, lighted stainless toggle switches, quick release windshield, smoked glass side door, 25 qt. cooler, removable stand access panel and glove box

- Full gauge panel featuring black sterling tachometer, voltmeter and fuel gauge
- Surface storage trays for cell phone and other personal items
- Woodgrain tilt steering wheel with brilliant aluminum non-directional spokes
- Sea Star hydraulic easy-to-turn tilt steering

### Electronics

- Jensen high power MSR3007 CD stereo with MP3 plug
- Four Jensen high power speakers with platinum speaker covers

- 12 volt power point

### Lighting

- Docking lights built into front walls in heavy duty reinforced housing
- Stainless courtesy light on side of Captain's stand
- USCG navigation and stern lighting

### Performance

- Waveglider™ system – high performance pontoons – includes 25" triple pontoons and Tahoe's exclusive Waveglider™ – high performance lifting strakes and 42 gallon fuel tank for center pontoon
- Ski tow bar

### Furnishings

- Furnishings are created using exclusive Matrix 50 marine upholstery
- Upholstered aluminum seat frames with dry floor matting and flow through ventilation

- Pleated plush radius designer furnishings
- Plush deluxe lounge arms
- Exclusive Comfort-Plush™ high back reclining Admiral's chair with slide and swivel
- Portable cup holders
- Port side bench
- Port privacy station

### Entertainment Areas

- Captain refreshment center with sink, electric SST faucet, two gallon water reservoir, trash can liner and storage
- Large rear swim platform area
- One port and one starboard rear swim platform ladder
- Rear bar and music center includes cup holders, remote stereo controls, 12 volt outlet, storage and cube cooler
- Two rear Admiral recliner chairs

- Round table with locking base at rear chairs

### Styling

- External wall skins with 29" high 1 1/4" diameter .090" anodized railings
- Hidden wall seams
- Non-skid strips for doorways
- Plush 28 oz. Escalade Hi-Lo carpet
- Deluxe graphics package
- Three dimensional raised logos

### Convenience

- Fire extinguisher
- Four stainless cleat and lifting eye assembly
- Latched door for privacy station

### Canvas and Top

- 10' Bimini top with boot
- Transport position support brackets
- Bimini quick release pull pins

- Color matched full mooring cover with vented pole supports

### Construction

- 8 1/2" wide
- Double full riser connections
- Heavy duty 3" reinforced deck rail
- Heavy duty C-channel crossbeams
- 16" OC crossbeam spacing
- Corner castings all four corners
- Extra heavy duty motor pod double bolted with 3/8" SST bolts attached to seven crossbeams
- Gate latches with stainless steel insert and welded safety tab

## OPTIONS

### Wall and Furniture Color Options

- See page 39

### Deck Options

- Aluminum decking

### Flooring Options

- Simulated teak flooring – see page 38
- Vinyl flooring (n/a on aluminum deck)
- Snap-in carpet (upgrade to vinyl flooring also required)
- Plush 28 oz. Islands carpet

### Captain's Chair Options

- See pages 36 and 37

### Furniture Options

- Table Options – see pages 36, 37 and 38
- Luxury umbrella with table (Tan only)

### Entertaining Options

- Refreshment center COMMANDER in place of lounge arm with sink, electric faucet, two gallon water reservoir, trash can liner and stainless drawer with ice cube cooler

- Refrigerator – DC electric stainless steel with slide out top loading cooling compartment in special housing with Corian style surface
- Stainless gas grill

### Dash/Electronics Options

- Fishfinder – GPS options – see page 36
- Premium sound system upgrade (six coaxial speakers, subwoofer, amp.)
- Jensen MSR2107 high power waterproof stereo with 1 GB storage and memory stick input (exchange)
- Additional Jensen speakers
- Marine Audio speakers upgrade
- Stainless logo speaker covers (requires M.A. speaker)
- Reserve battery system with Start Now protection
- Battery selector switch

### Lighting Options

- Stainless amber floor mood lighting

### Steering Options

- Electric power assist steering

### Bimini and Hard Top Options

- Six stainless steel easy to use twist lock Bimini quick connect (available only on 8 1/2' x 10' Bimini top)
- Second Bimini top – factory pre-installed only
- Standard walk-on sun roof (8' or 10') with ladder (ladder at front of roof). Upgrade to 25' pontoons required. Available factory installed only, 22" and up only.
- 12" aluminum hard top (factory installed only)

### Pontoon Options

- Exclusive side protector keels

### Performance Options

- Sport Graphics Package – see page 20
- Aluminum Waveshield

### Watersports Options

- Waterski/wakeboard tower

### Camper Enclosure Options – Factory Pre-installed Only

- See page 36

### Misc. Options

- Livewell under port bow bench
- Wash down kit with sprayer and pump

## INTERIOR OPTIONS

### VISTA SANDBAR

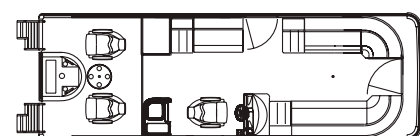

26'

## SPECIFICATIONS

LENGTH	26'
Pontoon Diameter	26" x 3
Width	8 1/2'
Dry Weight	3,125
Max. Weight Cap.	3,200
Max. Engine HP	300
Max. # People	17
Max. People Lbs.	2,400

- Seat covers in place of, or in addition to, mooring cover
- Docklines retractable built in
- Trash can built into lounge arm
- Wine rack built in to lounge arm

### Vista Sandbar Additional Options

- Refreshment center COMMANDER in place of Captain refreshment center
- 27" Center pontoon



Vista Sandbar 26'

Vista Sandbar 26'

Some models shown with optional equipment.



2011  
**Tahoe**  
PONTOON BOATS

**GET READY TO PARTY!**

Park at your favorite cove and watch how a great stereo, the standard rear entertainment bar and the easy access rear deck with plenty of dancing room will have everyone coming to your SANDBAR to party the day away!

C  
SERIES

## STANDARD FEATURES

**Helmsman Fiberglass Stand**

- Level 3 helm package – automotive style vinyl wrapped dash with woodgrain panels, lighted stainless toggle switches, quick release windshield, smoked glass side door, 25 qt. cooler, removable stand access panel and glove box

- Full gauge panel featuring black sterling tachometer, voltmeter and fuel gauge

- Surface storage trays for cell phone and other personal items

- Woodgrain tilt steering wheel with brilliant aluminum non-directional spokes

- Sea Star hydraulic easy-to-turn tilt steering

**Electronics**

- Jensen high power MSR3007 CD stereo with MP3 plug

- Two Jensen high power speakers with platinum speaker covers
- 12 volt power point

**Lighting**

- Docking lights built into front walls in heavy duty reinforced housing

- Stainless courtesy light on side of Captain's stand

- USCG navigation and stern lighting

**Performance**

- Waveglider™ system – high performance pontoons – includes 25" triple pontoons and Tahoe's exclusive

- Waveglider™ – high performance lifting strakes and 42 gallon fuel tank for center pontoon
- Ski tow bar

**Furnishings**

- Furnishings are created using exclusive Matrix 50 marine upholstery

- Upholstered aluminum seat frames with dry floor matting and flow through ventilation

- Pleated plush radius designer furnishings

- Plush deluxe lounge arms
- Captain plush fixed back driver's chair with arms

- Portable cup holders

**Funship Special Equipment**

- Deluxe 10' walk-on sun roof with rear ladder, Waterpark™ slide with waterfall water pump, decorative walls, king size upper deck lounge with backs and cushions, upper deck entertainment center with remote, stereo controls, two speakers and storage

**Styling**

- Front radius wall railings

- Rear entry gate with swim platform rear entry ladder

- External wall skins with 29" high 1 1/4" diameter .090" anodized railings

- Hidden wall seams
- Non-skid strips for doorways

- Plush 28 oz. Escalade Hi-Lo carpet
- Deluxe graphics package

- Three dimensional raised logos

**Convenience**

- Fire extinguisher

- Four stainless cleat and lifting eye assembly

- Thermoform curved table with locking floor base
- Latched door for privacy station

**Canvas and Top**

- Color matched full mooring cover with vented pole supports

**Construction**

- 8 1/2" wide

- 25" diameter pontoons

- Double full riser connections

- Heavy duty 3" reinforced deck rail

- Heavy duty C-channel crossbeams

- 16" OC crossbeam spacing

- Corner castings all four corners

- Extra heavy duty motor pod double bolted with lifting eye assembly

- Gate latches with stainless steel insert and welded safety tab

## OPTIONS

**Wall and Furniture Color Options**

- See page 39

**Deck Options**

- Aluminum decking

**Flooring Options**

- Simulated teak flooring – see page 38
- Vinyl flooring (n/a on aluminum deck)

- Snap-in carpet (upgrade to vinyl flooring also required)
- Plush 28 oz. Islands carpet

**Captain's Chair Options**

- See pages 36 and 37

**Furniture Options**

- Table Options – see pages 36, 37 and 38
- Luxury umbrella with table (Tan only)

**Entertaining Options**

- Refreshment center COMMANDER in place of lounge arm with sink, electric faucet, two gallon water reservoir, trash can liner and stainless drawer with ice cube cooler

- Refreshment center CAPTAIN in place of lounge arm with sink, electric faucet, two gallon water reservoir, trash can liner and smoked glass style door

- Refrigerator – DC electric stainless steel with slide out top loading cooling compartment in special housing with Corian style surface

- Stainless gas grill

**Dash/Electronics Options**

- Fishfinder – GPS options – see page 36
- Premium sound system upgrade (six coaxial speakers, subwoofer, amp.)

- Jensen MSR2107 high power waterproof stereo with 1 GB storage and memory stick input (exchange)

- Additional Jensen speakers
- Marine Audio speakers upgrade

- Stainless logo speaker covers (requires M.A. speaker)
- Reserve battery system with Start Now protection

- Battery selector switch

**Lighting Options**

- Stainless amber floor mood lighting

**Steering Options**

- Electric power assist steering

**Bimini and Hard Top Options**

- Six stainless steel easy-to-use twist lock Bimini quick connect (available only on 8 1/2" x 10' Bimini top)

- Second Bimini top – factory pre-installed only

**Pontoon Options**

- Exclusive side protector keels

**Performance Options**

- Sport Graphics Package – see page 20
- Aluminum Waveshield

- Camper Enclosure Options – Factory Pre-installed Only
- See page 36

**Misc. Options**

- Livewell under port bow bench
- Wash down kit with sprayer and pump

- Seat covers in place of, or in addition to, mooring cover
- Docklines retractable built in

- Trash can built into lounge arm
- Wine rack built in to lounge arm

## INTERIOR OPTIONS

## VISTA FUNSHIP

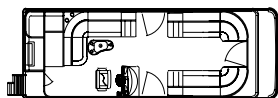

24'

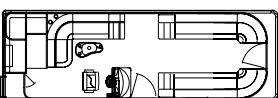
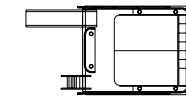

26'

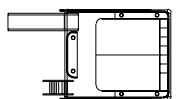

## SPECIFICATIONS

LENGTH	24'	26'
Pontoon Diameter	25" x 3	25" x 3
Width	8 1/2'	8 1/2'
Dry Weight	3,750	3,850
Max. Weight Cap.	2,665	2,990
Max. Engine HP	225	250
Max. # People	14	16
Max. People Lbs.	1,910	2,190

2011  
**Tahoe**  
PONTOON BOATS



# VISTA FUNSHIP



Vista Funship 26'

Vista Funship 24'

## NOW EVERYONE CAN ENJOY A DAY OF SLIDING,

skiing, sunbathing and cruising with the most affordable water park model anywhere! Enjoy all the VISTA FUNSHIP features, including the slide, king-size sunbathing area and Tahoe's Waveglider™ system for a complete do-everything Funship!

Some models shown with optional equipment.



C  
SERIES

## STANDARD FEATURES

**Helmman Fiberglass Stand**

- Level 3 helm package – automotive style vinyl wrapped dash with woodgrain panels, lighted stainless toggle switches, quick release windshield, smoked glass side door, 25 qt. cooler, removable stand access panel and glove box
- Full gauge panel featuring black sterling tachometer, voltmeter and fuel gauge
- Surface storage trays for cell phone and other personal items
- Woodgrain tilt steering wheel with brilliant aluminum non-directional spokes

**Electronics**

- Jensen high power MSR3007 CD stereo with MP3 plug
- Two Jensen high power speakers with platinum speaker covers
- 12 volt power point

**Lighting**

- Docking lights built into front walls in heavy duty reinforced housing

- Stainless courtesy light on side of Captain's stand
- USCG navigation and stern lighting

**Furnishings**

- Furnishings are created using exclusive Matrix 50 marine upholstery
- Upholstered aluminum seat frames with dry floor matting and flow through ventilation
- Plush deluxe lounge arms
- Portable cup holders

**Styling**

- External wall skins with 29" high 1 1/4" diameter .090" anodized railings
- Hidden wall seams
- Non-skid strips for doorways
- Plush 28 oz. Escalade Hi-Lo carpet
- Deluxe graphics package
- Three dimensional raised logos

**Convenience**

- Fire extinguisher
- Four stainless cleat and lifting eye assembly
- 24 gallon fuel capacity

- Thermoform curved table with locking floor base
- 10' Bimini top with boot
- Transport position support brackets
- Bimini quick release pull pins
- Color matched full mooring cover with vented pole supports

**Construction**

- 8 1/2" wide
- Two – 25" diameter pontoons
- Double full riser connections
- Heavy duty 3" reinforced deck rail
- Heavy duty C-channel crossbeams
- 16" OC crossbeam spacing
- Corner castings all four corners
- Extra heavy duty motor pod double bolted with 3/8" SST bolts attached to seven crossbeams
- Gate latches with stainless steel insert and welded safety tab

**Additional Blue Ridge Features**

- Captain plush fixed back driver's chair with arms
- Large bow deck area
- 2' rear deck area with two swim platform ladders
- Privacy station with latched door

**Additional Vista RC Features**

- Two bow commander reclining Comfort-Plush™ chairs
- Exclusive Comfort-Plush™ high back reclining Admiral's chair with slide and swivel
- Pleated plush radius designer furnishings
- Round bow table with locking base at front chairs
- Front radius fishing height wall railings
- Rear entry gate with swim platform rear entry ladder
- Latched door for privacy station on Elite models

## INTERIOR OPTIONS

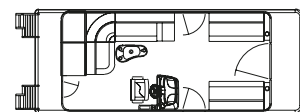
**BLUE RIDGE RD**

22'

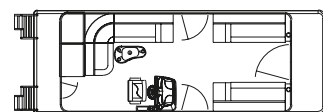

24'

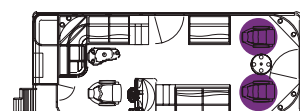
**VISTA RC RE**

22'



24'

**VISTA RC ELITE**

## OPTIONS

**Wall and Furniture Color Options**

- See page 39

**Deck Options**

- Aluminum decking

**Flooring Options**

- Simulated teak flooring – see page 38
- Vinyl flooring (n/a on aluminum deck)
- Snap-in carpet (upgrade to vinyl flooring also required)
- Plush 28 oz. Islands carpet

**Captain's Chair Options**

- See pages 36 and 37

**Furniture Options**

- Table options – see page 36, 37 and 38
- Luxury umbrella with table (Tan only)

**Entertaining Options**

- Refreshment center COMMANDER in place of lounge arm with sink, electric faucet, two gallon water reservoir, trash can liner and stainless drawer with ice cube cooler

- Refreshment center CAPTAIN in place of lounge arm with sink, electric faucet, two gallon water reservoir, trash can liner and smoked glass style door
- Refrigerator – DC electric stainless steel with slide out top loading cooling compartment in special housing with Corian style surface
- Stainless gas grill

- Reserve battery system with Start Now protection
- Battery selector switch

**Lighting Options**

- Stainless amber floor mood lighting

**Steering Options**

- Baystar hydraulic easy-to-turn tilt steering
- Sea Star hydraulic steering for motors over 150 hp
- Electric power assist steering (requires Sea Star upgrade)

**Bimini and Hard Top Options**

- Six stainless steel easy-to-use twist lock Bimini quick connect (available only on 8 1/2' x 10' Bimini top)
- Second Bimini top – factory pre-installed only
- Standard walk-on sun roof (8' or 10') with ladder (ladder at front of roof except 8' on Elite models). Upgrade to 25" pontoons required.
- 12" aluminum hard top (factory installed only)

**Pontoon Options**

- Exclusive side protector keels

**Performance Options**

- Waveglider™ high performance pontoons – see pages 18 and 19
- Sport Graphics Package – see page 20
- Aluminum Waveshield

**Watersports Options**

- Waterski/wakeboard tower

**Camper Enclosure Options – Factory Pre-installed Only**

- See page 36

**Misc. Options**

- Livewell under port bow bench
- Wash down kit with sprayer and pump
- Seat covers in place of, or in addition to, mooring cover
- Docklines retractable built in
- Trash can built into lounge arm
- Wine rack built in to lounge arm

## SPECIFICATIONS

## Vista RC &amp; Blue Ridge

	22'	24'
LENGTH	22'	24'
Pontoon Diameter	25"	25"
Width	8 1/2'	8 1/2'
Dry Weight	2,800	3,000
Max. Weight Cap.	2,650	2,850
Max. Engine HP	225	250
Max. # People	12	15
Max. People Lbs.	1,780	2,080

**Additional Blue Ridge Options**

- RD ski tow bar

**Additional Vista RC Options**

- Convenience center with Corian style surface, paper towel holder and storage (Elite interior only)

- Exclusive fiberglass easy access dual battery box
- Engine compartment light
- Ski tow bar



Vista RC 22' RE



Some models shown with optional equipment.

VISTA RC  BLUE RIDGE

Vista RC 24' Elite



Blue Ridge 24' RD

## A BESTSELLER FOR YEARS

The affordable, durable and feature-packed TAHOE BLUE RIDGE has been a favorite for thousands of families! Enjoy lounge arms, soft plush furnishings, a CD stereo, built-in dock lights and a luxurious Captain's chair all mounted on heavy-duty construction with 16" on-center crossbeams and full riser connectors. It's built to create memories for many years to come.

**Tahoe**  
PONTOON BOATS

C  
SERIES

## STANDARD FEATURES

### Helmsman Fiberglass Stand

- Level 3 helm package – carbon fiber dash with platinum panels, lighted stainless toggle switches, quick release windshield, smoked glass side door, 25 qt. cooler, removable stand access panel and glove box

- Full gauge panel featuring black sterling tachometer, voltmeter and fuel gauge
- Surface storage trays for cell phone and other personal items
- Carbon fiber tilt steering wheel with brilliant aluminum non-directional spokes

### Electronics

- Garmin 400C color Fishfinder
- Jensen high power MSR3007 CD stereo with MP3 plug
- Two Jensen high power speakers with platinum speaker covers
- 12 volt power point

### Lighting

- Docking lights built into front walls in heavy duty reinforced housing
- Stainless courtesy light on side of Captain's stand
- USCG navigation and stern lighting

### Furnishings

- Furnishings are created using exclusive Matrix 50 marine upholstery
- Upholstered aluminum seat frames with dry floor matting and flow through ventilation
- Plush designer furnishings
- Plush deluxe lounge arms
- Captain plush fixed back driver's chair with arms
- Portable cup holders

### Fishing Features

- Two front fishing stations with rod holder (FNF, FNC)
- Two rear fishing stations with rod holder
- Rear rod box
- Tackle trays

### Canvas and Top

- Large livewell over fuel tank
- Small livewell underbow bench (FNF, FNC)

### Styling

- Front fishing height walls (FNF, FNC)
- Rear fishing height walls (FNF, FNC, RF)
- Two bow benches (RF, FNC)
- External wall skins with 29" high 1 1/4" diameter .090" anodized railings
- Hidden wall seams
- Non-skid strips for doorways
- Plush 28 oz. Escalade Hi-Lo carpet
- Deluxe graphics package
- Three dimensional raised logos

### Convenience

- Fire extinguisher
- Four stainless cleat and lifting eye assembly
- 24 gallon fuel capacity
- Thermoform curved table with locking floor base
- Privacy station with latched door

### Construction

- 8 1/2" wide
- Two - 25" diameter pontoons
- Double full riser connections
- Heavy duty 3" reinforced deck rail
- Heavy duty C-channel crossbeams
- 16" OC crossbeam spacing
- Corner castings all four corners
- Extra heavy duty motor pod double bolted with 3/8" SST bolts attached to seven crossbeams
- Gate latches with stainless steel insert and welded safety tab

## INTERIOR OPTIONS

### SE-B FISH FISH N' CRUISE RE

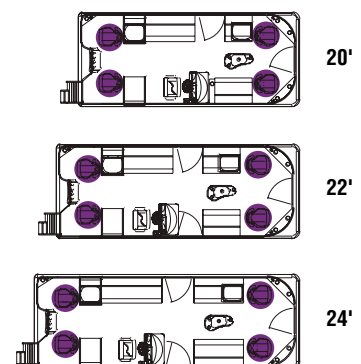

### SE-B FISH REAR FISH RE

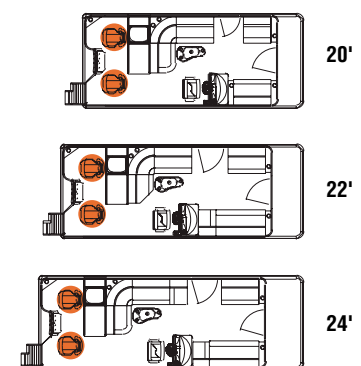

### SE-B FISH FISH N' FUN RE

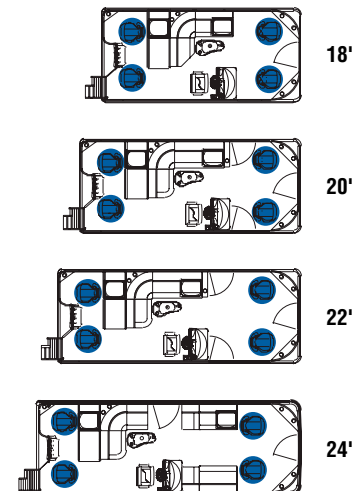

## OPTIONS

### Wall and Furniture Color Options

- See page 39

### Deck Options

- Aluminum decking

### Flooring Options

- Simulated teak flooring – see page 38
- Vinyl flooring (n/a on aluminum deck)
- Snap-in carpet (upgrade to vinyl flooring also required)
- Plush 28 oz. Islands carpet

### Captain's Chair Options

- See pages 36 and 37

### Furniture Options

- Table options – see pages 36, 37 and 38
- Luxury umbrella with table (Tan only)

### Entertaining Options

- Stainless gas grill

### Dash/Electronics Options

- GPS options – see page 36
- Premium sound system upgrade (six coaxial speakers, subwoofer, amp.)

- Jensen MSR2107 high power waterproof stereo with 1 GB storage and memory stick input (exchange)
- Additional Jensen speakers
- Marine Audio speakers upgrade
- Stainless logo speaker covers (requires M.A. speaker)
- Reserve battery system with Start Now protection
- Battery selector switch

- Second Bimini top – factory pre-installed only
- 12' aluminum hard top (factory installed only)

### Lighting Options

- Stainless amber floor mood lighting

### Steering Options

- Baystar hydraulic easy-to-turn tilt steering
- Sea Star hydraulic steering for motors over 150 hp
- Electric power assist steering (requires Sea Star upgrade)

### Bimini and Hard Top Options

- Six stainless steel easy-to-use twist lock Bimini quick connect (available only on 8 1/2' x 10' Bimini top)

## SPECIFICATIONS

LENGTH	18'	20'	22'	24'
Pontoon Diameter	25"	25"	25"	25"
Width	8 1/2"	8 1/2"	8 1/2"	8 1/2"
Dry Weight	1,650	1,800	2,050	2,250
Max. Weight Cap.	1,870	2,130	2,350	2,600
Max. Engine HP	90	115	125	150
Max. # People	9	10	11	13
Max People Lbs.	1,270	1,380	1,600	1,850

- Second Bimini top – factory pre-installed only
- 12' aluminum hard top (factory installed only)

### Pontoon Options

- Exclusive side protector keels

### Performance Options

- Waveglider™ high performance pontoons – see pages 18 and 19
- Sport Graphics Package – see page 20
- Aluminum Waveshield

- Ski tow bar
- Waterski/wakeboard tower

### Camper Enclosure Options – Factory Pre-installed Only

- See page 36

### Misc. Options

- Wash down kit with sprayer and pump
- Seat covers in place of, or in addition to, mooring cover
- Docklines retractable built in
- Trash can built into lounge arm
- Wine rack built in to lounge arm



SE-B Fish 20' FNF

SE-B Fish 20' FNC

SE-B Fish 22' RF

# SE-B FISH

# 2011 Tahoe

PONTOON BOATS

## MORE PEOPLE THAT FISH CHOOSE SE-B FISH

Only Tahoe gives you your choice of five fully loaded fishing models featuring livewells, comfortable fishing chairs and a Garmin Fishfinder graph. Most models include a built in tackle box, rod holders and a rod storage box too. With all of the different fishing layouts available in the TAHOE SE-B FISH, it should be easy to find the fishing set-up that's just right for your family.





## STANDARD FEATURES

**Captain's Deluxe Polished Contoured Stand**

- Smoked glass side door and removable stand access panel
- Full gauge panel featuring black sterling tachometer, voltmeter and fuel gauge
- Surface storage tray for cell phone and other personal items
- Quick release windshield

**Electronics**

- Jensen high power MSR3007 CD stereo with MP3 plug
- Two Jensen high power speakers with platinum speaker covers
- 12 volt power point

**Lighting**

- Stainless courtesy light on side of Captain's stand
- USCG navigation and stern lighting

**Furnishings**

- Furnishings are created using exclusive Matrix 50 marine upholstery

- Upholstered aluminum seat frames with flow through ventilation
- Plush custom furnishings
- Champagne perf accent vinyl
- Lounge arms with storage
- Custom driver's chair

**Styling**

- Front radius walls
- Rear entry gate with swim platform rear entry ladder
- External wall skins with 29" high 1 1/4" diameter .090" anodized railings
- Hidden wall seams
- Non-skid strips for doorways
- Plush 20 oz. textured carpet
- Mural graphics package

**Convenience**

- Four stainless cleat and lifting eye assembly
- Oval table with cup holders
- 12 gallon fuel system

**Canvas and Top**

- 8' Bimini top with boat
- Transport position support brackets

- Bimini quick release pull pins

**Construction**

- Two - 23" standard or optional 25" diameter pontoons
- Heavy duty 3" reinforced deck rail
- Heavy duty C-channel crossbeams
- Corner castings all four corners
- Extra heavy duty motor pod double bolted with 3/8" SST bolts attached to seven crossbeams
- Gate latches with stainless steel insert and welded safety tab

**Additional Cascade Features**

- Level 2 helm package - woodgrain dash panel with lighted rocker switches
- Woodgrain insert steering wheel
- Lounge arms with storage
- Latched door for privacy station on Elite models

- 8' standard or optional 8 1/2' wide

**Additional SE-C Fish Features**

- Level 2 helm package - carbon fiber dash panel with lighted rocker switches
- Huron black steering wheel
- Garmin 145 Fishfinder
- Seat arms with storage
- Two front fishing stations with rod holder (FNF)
- Two rear fishing stations with rod holder (FNF, RF)
- Two fishing chairs on front deck (BF)
- Large livewell over fuel tank (FNF, RF)
- Small livewell under bow bench (BF)
- Front fishing height walls (FNF)
- Rear fishing height walls (FNF, RF)
- Two bow benches
- Latched door for privacy station (FNF, RF)
- 8' wide

## SPECIFICATIONS

Length	SE-C Fish		Cascade		SE-C Fish & Cascade		
	14'	16'	16'	18'	20'	22'	24'
<b>STANDARD PONTOON DIA.</b>	23"	23"	23"	23"	23"	23"	23"
<b>Standard Width</b>	7'	7'	8'	8'	8'	8'	8'
Dry Weight	1150	1350	1,380	1,600	1,750	2,000	2,200
Max. Weight Cap.	1220	1450	1,350	1,575	1,805	2,000	2,210
Max. Engine HP	40	50	50	75	90	100	130
Max. # People	5	6	6	8	9	10	11
Max. People Lbs.	800	950	950	1,070	1,250	1,450	1,530
<b>OPTIONAL PONTOON DIA.</b>	-	-	25"	25"	25"	25"	-
<b>Optional Width</b>	-	-	8 1/2'	8 1/2'	8 1/2'	8 1/2'	8 1/2'
Dry Weight	-	-	1,425	1,650	1,800	2,050	2,250
Max. Weight Cap.	-	-	1,580	1,870	2,130	2,350	2,600
Max. Engine HP	-	-	60	90	115	125	150
Max. # People	-	-	7	9	10	11	13
Max. People Lbs.	-	-	1,050	1,270	1,380	1,600	1,850

## OPTIONS

**Wall and Furniture Color Options**

- See page 39

**Deck Options**

- Aluminum decking

**Flooring Options**

- Simulated teak flooring - see page 38
- Vinyl flooring (n/a on aluminum deck)
- Snap-in carpet (upgrade to vinyl flooring also required)
- Plush 28 oz. Escalade carpet
- Plush 28 oz. Islands carpet

**Captain's Chair Options**

- See pages 36 and 37

**Furniture Options**

- Table options - see pages 36, 37 and 38
- Luxury umbrella with table (Tan only)

**Dash/Electronics Options**

- Fishfinder - GPS options - see page 36
- Premium sound system upgrade (six coaxial speakers, subwoofer, amp.)

- Jensen MSR2107 high power waterproof stereo with 1 GB storage and memory stick input (exchange)
- Additional Jensen speakers
- Marine Audio speakers upgrade
- Stainless logo speaker covers (requires M.A. speaker)
- Battery selector switch

- Additional Jensen speakers

- Marine Audio speakers upgrade

- Stainless logo speaker covers (requires M.A. speaker)

- Battery selector switch

**Lighting Options**

- Stainless amber floor mood lighting
- Docking lights built into front walls (includes standard white docklight housings)
- Chrome housings for docklights

**Steering Options**

- Mechanical tilt steering
- Baystar hydraulic easy-to-turn tilt steering
- Sea Star hydraulic steering for motors over 150 hp
- Electric power assist steering (requires Sea Star upgrade)

**Bimini and Hard Top Options**

- 8' x 10' Bimini top with logo boot
- Second Bimini top - factory pre-installed only
- 12' aluminum hard top (factory installed only)

**Pontoon Options**

- 23" to 25" upgrade
- Exclusive side protector keels

**Performance Options**

- Waveglider™ high performance pontoons - see pages 18 and 19
- Sport Graphics Package - see page 20
- Aluminum Waveshield

**Watersports Options**

- Ski tow bar
- Waterski/wakeboard tower - 8.5' wide only

**Camper Enclosure Options - Factory Pre-installed Only**

- See page 36

**Entertaining Options**

- Stainless gas grill

**Misc. Options**

- Livewell under port bow bench

- Wash down kit with sprayer and pump
- Color matched seat covers
- Color matched full mooring cover
- Docklines retractable built in
- Logo soft cooler
- Portable cup holders
- Six stainless steel easy-to-use twist lock Bimini quick connect (available only on 8 1/2' x 10' Bimini top)

- Color matched seat covers

- Color matched full mooring cover

- Docklines retractable built in

- Logo soft cooler

- Portable cup holders

- Six stainless steel easy-to-use twist lock Bimini quick connect (available only on 8 1/2' x 10' Bimini top)

- Reserve battery system with Start Now protection

- Engine compartment light

- Convenience center with Corian style surface, paper towel holder and storage (Elite interior only)

- Standard walk-on sun roof (8' or 10') with ladder (ladder at front of roof except 8' on Elite models) upgrade to 25" pontoons required. Available factory installed only, 22' and up only.

## INTERIOR OPTIONS

**SE-C FISH N' FUN RE**

18'

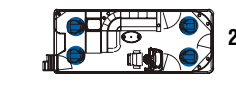

20'



22'

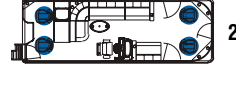

24'

**SE-C BOW FISH RE**

18'

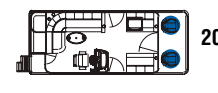

20'



22'

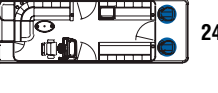

24'

**SE-C REAR FISH**

20'

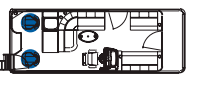

22'

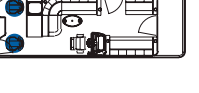

24'

**CASCADE REAR ENTRY**

16'

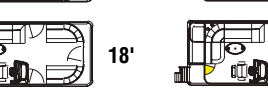

18'

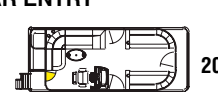
**CASCADE ELITE**

20'

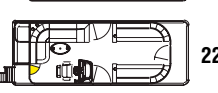

22'

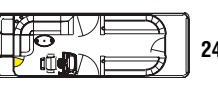

24'



Cascade 22' EL



Cascade 18' RE



Cascade 16' RE

## EVEN THOUGH CASCADE IS TAHOE'S MOST AFFORDABLE

full size model, it sure doesn't look like it. A great way to start boating with high quality and less investment, the TAHOE CASCADE won't disappoint. Cascade is built with the same quality that goes into every Tahoe. Solid structure, plush Matrix 50 seating, CD stereo and gauges provide the right amount of features for years of fun on the water.



SE-C Fish 20' FF



SE-C Fish 18' REBF



SE-C Fish 22' RF

## THE ECONOMICAL

SE-C FNF brings four-point fishing to any budget. Enjoy a livewell and rod holders along with lots of storage in this core fishing model that has plenty of room and fishing power without all the frills.



## STANDARD FEATURES

- Captain's Deluxe Polished Contoured Stand**
- Level 1 helm package – brushed champagne dash panel lighted rocker switches
  - Smoked glass side door and removable stand access panel
  - Non-directional Huron steering wheel
- Electronics**
- 12 volt power point
- Lighting**
- Stainless courtesy light on side of Captain's stand
  - USCG navigation and stern lighting
- Furnishings**
- Furnishings are created using exclusive Matrix 50 marine upholstery
  - Upholstered aluminum seat frames with flow through ventilation

- Radius plush designer furnishings
  - Champagne perf accent vinyl
- Family Models**
- Two front bow benches (Family models)
- Fishing Models**
- Two front fishing chairs
  - Livewell under port bench
- Styling**
- Front radius walls
  - External wall skins with 26" high 1 1/4" diameter .090" anodized railings
  - Hidden wall seams
  - Non-skid strips for doorways
  - Plush 20 oz. textured carpet
  - Mural graphics package

- Convenience**
- Four stainless cleat and lifting eye assembly
- Canvas and Top**
- 8' x 7' Bimini top with boot
  - Bimini quick release pull pins
- Construction**
- 7' wide
  - 23" pontoons
  - Heavy duty 3" reinforced deck rail
  - Heavy duty C-channel crossbeams
  - Corner castings all four corners
  - Extra heavy duty motor pod double bolted with 3/8" SST bolts attached to seven crossbeams
  - Gate latches with stainless steel insert and welded safety tab

## INTERIOR OPTIONS

### SPORT FAMILY

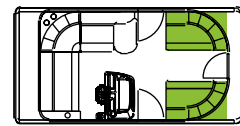

14'

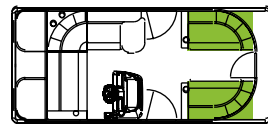

16'

### SPORT 16' OPTIONAL FAMILY RE

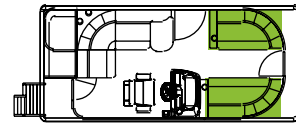

16'

### SPORT FISH

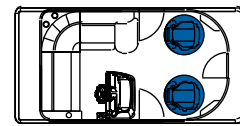

14'

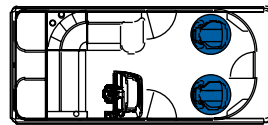

16'

### SPORT 16' OPTIONAL FISH RE

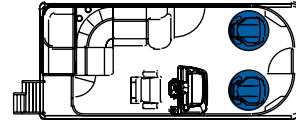

16'

- Wall and Furniture Color Options**
- See page 39
- Deck Options**
- Aluminum decking
- Flooring Options**
- Vinyl flooring (n/a on aluminum deck)
  - Snap-in carpet (upgrade to vinyl flooring also required)
  - Plush 28 oz. Escalade carpet
  - Plush 28 oz. Islands carpet
- Furniture Options**
- Table options – see pages 36, 37 and 38
  - Rear entry gate with ladder and custom Captain's chair (16' only)
- Dash/Electronics Options**
- Tachometer, voltmeter and fuel gauge
  - Jensen high power MSR3007 CD stereo with MP3 plug
  - Jensen waterproof CD stereo MSR7007
  - Jensen high power speakers with platinum speaker covers
  - Additional Jensen speakers
  - Marine Audio speakers exch.
  - Stainless logo speaker covers (requires M.A. speaker)

- Misc. Options**
- Fishfinder – GPS options – see page 36
  - Battery selector switch • Fixed windshield
  - Wash down kit with sprayer and pump
  - Color matched seat covers
  - Color matched full mooring cover
  - Docklines retractable built in
  - Logo soft cooler
  - Portable cup holders
  - Six stainless steel easy-to-use twist lock Bimini quick connect (available only on 8 1/2' x 10' Bimini top)
- Lighting Options**
- Stainless amber floor mood lighting
  - Docking lights built into front walls (includes standard white docklight housings)
  - Chrome housings for docklights
- Steering Options**
- Mechanical tilt steering
- Pontoon Options**
- 23" to 25" upgrade
  - Exclusive side protector keels

## SPECIFICATIONS

LENGTH	14'	16'
Width	7'	7'
Pontoon Diameter	23"	23"
Dry Weight	1,150	1,350
Max. Weight Cap.	1,220	1,450
Max. Engine HP	40	50
Max. # People	5	6
Max. People Lbs.	800	950



Sport Family 14'

# AMERICA'S BEST COMPACT PONTOON

You can take the stylish TAHOE SPORT anywhere. The 7' wide body is easy to trailer, requires only small gas horsepower and is perfect for electric outboards. The plush feel and classy radius look will have you looking smart in this economical pontoon boat.



Sport FAM 16'



Sport Fish 16'



Sport Fish 14'



Sport FAM 16' with optional RE





- 1 Aluminum deck
- 2 Camper enclosure – full (22' & Up)
- 3 Camper enclosure – half with bow cover
- 4 Camper enclosure – half
- 5 Escalade carpet
- 6 Islands carpet
- 7 Chair – custom
- 8 Chair – Captain
- 9 Chair – Commander recliner
- 10 Chair – Admiral recliner
- 11 Chair – Admiral doublewide
- 12 Chair – sport barrel
- 13 Convenience center
- 14 Mooring cover
- 15 Seat covers
- 16 Cup holder lighted
- 17 Cup holder portable
- 18 Dinette port bow – 22' & up (except SE-B & SE-C Fish)
- 19 Fishfinder Garmin 145 (not GPS)
- 20 Fishfinder Garmin 400c (not GPS)
- 21 GPS/Fishfinder Garmin 431S or upgrade to Coastal 441S
- 22 Gas grill
- 23 Light – engine compartment
- 24 Lights – mood
- 25 Lights – rubrail
- 26 Lights – rear underwater
- 27 Livewell under bench
- 28 MSR 2107 stereo
- 29 Refreshment center Captain
- 30 Refreshment center Commander
- 31 Refrigerator center
- 32 Table – round plastic
- 33 Table – oval plastic
- 34 Table – kidney thermal form
- 35 Table – small round cocktail smoked glass
- 36 Table – large round smoked glass

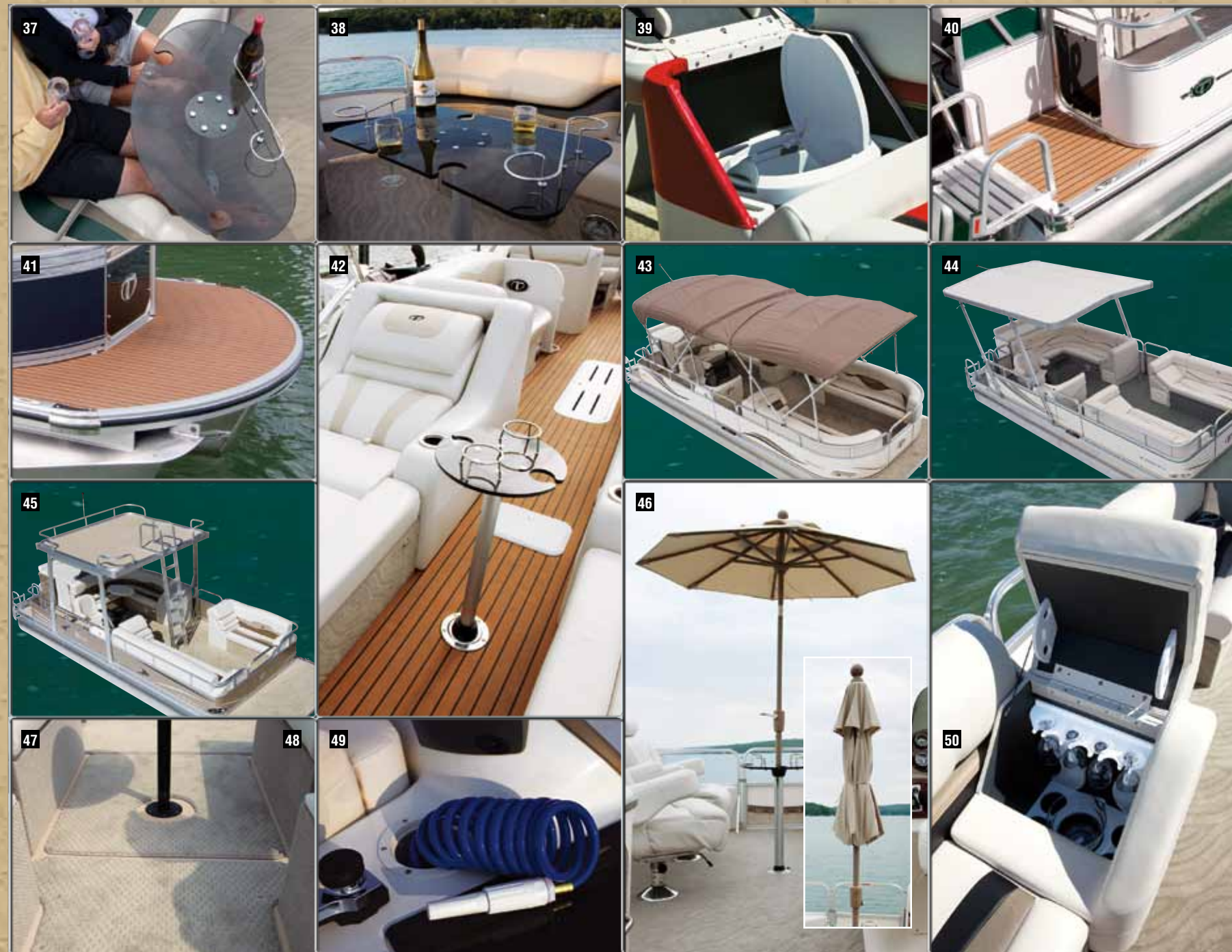

- 37 Table – curved smoked glass
- 38 Table – rectangular smoked glass
- 39 Trash can for lounge arm
- 40 Simulated teak – rear entry
- 41 Simulated teak – front deck
- 42 Simulated teak – full deck
- 43 Top – dual Bimini 22' & up
- 44 Top – 12' aluminum top 20' & up
- 45 Top – 8' or 10' walk on sunroof – 22' & up, 25" pontoons required. Ladder at rear on Elite interior only.
- 46 Umbrella (requires table with receiver)
- 47 Vinyl flooring
- 48 Snap in carpet
- 49 Washdown kit
- 50 Wine Rack for lounge arm

DECO SERIES			
Main	Accent	Pipe Trim	Carpet
<b>BLUEONCE</b>			
<b>SAGE</b>			
<b>BLACK</b>			
<b>RED</b>			
<b>TOPAZ</b>			
<b>YELLOW</b>			
<b>BURGUNDY</b>			
<b>BROWN</b>			
<b>NAVY</b>			
<b>GREEN</b>			

C SERIES / A SERIES			
Main	Accent	Pipe Trim	Carpet
<b>BLUEONCE</b>			
<b>SAGE</b>			
<b>BLACK</b>			
<b>RED</b>			
<b>TOPAZ</b>			
<b>YELLOW</b>			
<b>BURGUNDY</b>			
<b>BROWN</b>			
<b>NAVY</b>			
<b>GREEN</b>			

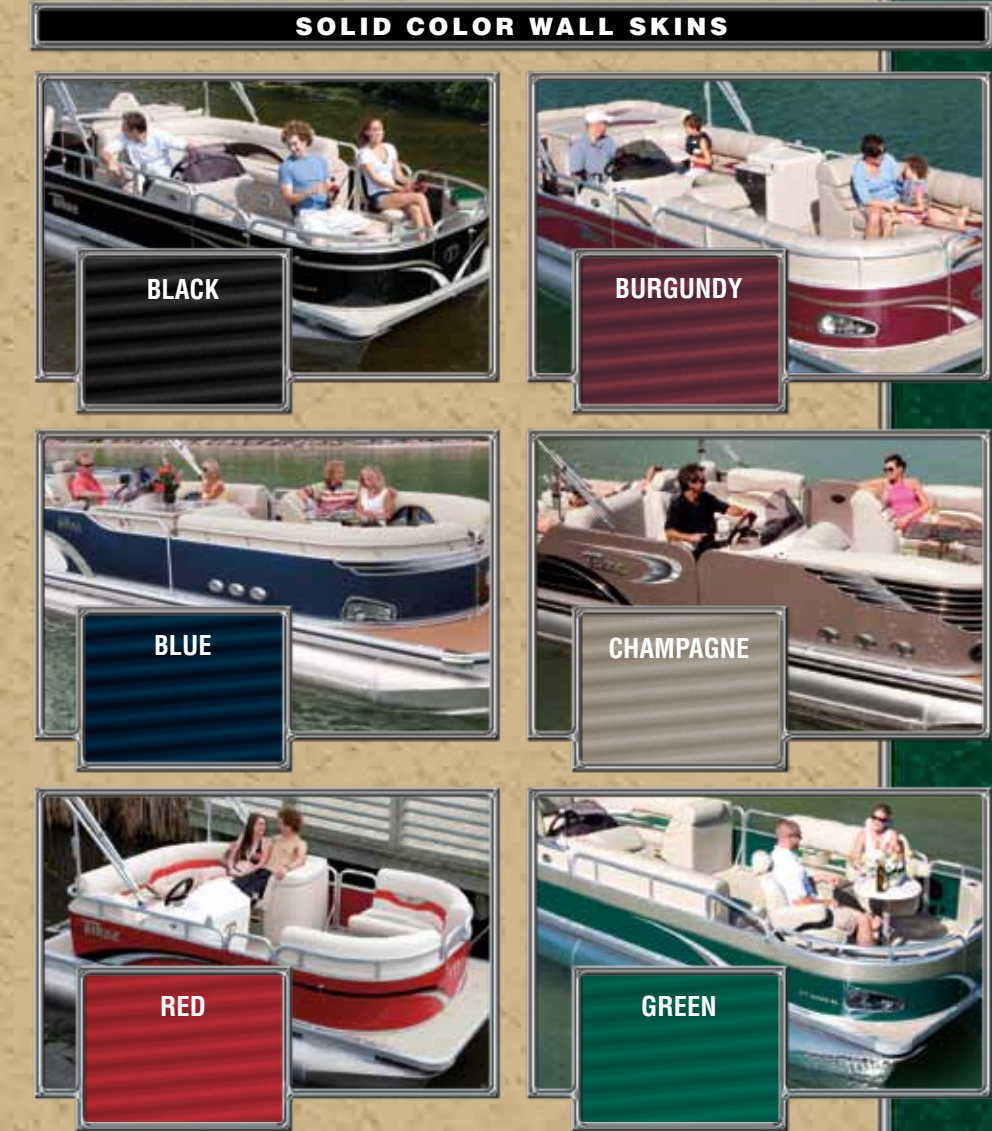

# THE CERTIFIED ADVANTAGE



The NMMA Certified label on a Tahoe Pontoon boat lets you know it was built to meet and often exceed, the industry's strictest quality and safety standards for critical components such as electrical systems, powering, flotation, fuel systems and navigation lights. Certified boats must also pass rigorous annual inspections from independent third-party inspectors. According to U.S. Coast Guard statistics NMMA Certified boats have been shown to be safer than non-certified boats.



**MATRIX-50**  
*Tested Strongest*

Tahoe's exclusive MATRIX 50 heavy duty 50 gauge marine seat coverings with a 24% substructure is tested strongest against tears, punctures and stains.

Dimensions, capacities, ratings and additional specifications plus complete warranty and service information are available from your Tahoe dealer. Product illustrations and data within this catalog are based upon information available at the time of publication. Tahoe reserves the right to make changes without notice or obligation. Ask your local Tahoe dealer for the most current product specifications prior to purchase. Some of the equipment shown separately or on products illustrated in this catalog may be optional at extra cost. All Tahoe boats meet or exceed the standards established by the ABYC and USCG flotation, fuel systems, ventilation, electrical and safety.



Graphic design by  
The F.P. Horak Company  
[www.fphorak.com](http://www.fphorak.com)

[www.tahoe pontoons.com](http://www.tahoe pontoons.com)



Tahoe's superior customer satisfaction is recognized by the **NMMA CSI AWARD** for 2008, 2009 and 2010!

# Tahoe

PONTOONS®

903 Michigan Avenue, Alma, Michigan 48801  
Worldwide: 800.334.2913 • 989.463.2112 • Fax: 989.463.8226

© 2011