



Tahoe

PONTOON BOATS

2012

Tahoe

PONTOON BOATS

LUXURY & STRENGTH.

Our total commitment to making the finest pontoon boats in the world has brought you the exciting Tahoe Pontoons. These luxurious boats are a beautiful composition of the finest elements known to pontoon boating, along with over 40 years of pontoon boat manufacturing experience. The finest construction, the most luxurious designs and the largest group of unique standard features create a distinctly different and clearly superior pontoon boat that will exceed your expectations.

Tahoe is a vertically integrated builder. We manufacture the pontoons, framing, furniture, covers and more right in our own production facility using the latest computer driven equipment such as our Water Jet cutter, Gerber fabric cutter, Tiger saws and the latest in welding technology. As a result we are able to achieve and control the highest degree of quality.

Our number one investment, however, is our people. Tahoe's team of highly experienced welders, furniture makers and assemblers descend from generations of Midwestern craftsmen that have been instrumental in the building of America. Our headquarters based customer service people will make sure your experience is exceptional.

Tahoe is rated as having one of the lowest incidents of warranty claims in the industry and has also won the 2008, 2009, 2010 and 2011 NMMA CSI Award for outstanding customer service.

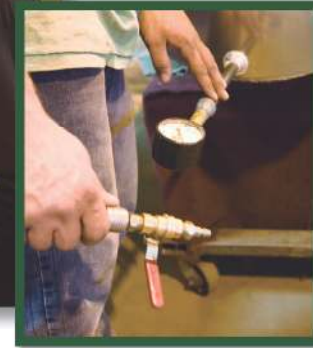

TAHOE PONTOONS OFFERS

MATRIX 50
Tested Strongest

- Tahoe's exclusive MATRIX 50 heavy duty 50 ounce marine seat covering with a 24% substructure is tested strongest against tears, punctures and stains.
- New Herringbone multi-directional stretch backing promotes quicker recovery.
- Greater stitch strength.

Exclusive! Aluminum seat frames and kick panels

Clearly superior. Lifetime warranty. Aluminum seat frames are stronger,

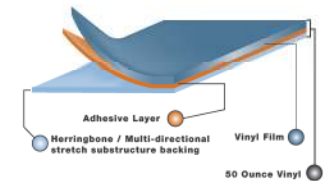

have extra large compartments for maximum storage capacity and have "Flo thru™" ventilation from the outside. "Flo thru™" allows your equipment to dry out, even while the cover is on and keeps the entire compartment drier so mildew or fungus is less likely to develop. Aluminum frames won't crack or hold water like plastic, either!



Tahoe PONTON BOATS

CONSTRUCTION



Five year Bow to Stern Limited Warranty PLUS Limited Lifetime flooring, pontoon weld and seat frame warranty.

CONSTRUCTION



THESE EXCLUSIVE HEAVY DUTY CONSTRUCTION FEATURES

Heavy duty nose cone with our industry-first integrated nose cone splash fins!

The absolute strongest in the industry. The .100" thickness and one-piece construction makes it virtually impossible to break off a splash fin. The double wrapped leading edge provides maximum impact protection.

Stronger! Double full pontoon connectors

Most models feature full riser pontoon connections inside and outside. Unlike our competitor's "small but skirted" riser connectors. Full risers provide continuous strength along the entire pontoon.

Exclusive! Deco Series side keel protection

Special welded keels protect against damage from side impact. They also provide better performance as they limit the flow of water around the pontoon.

Interior drain

Tahoe now exclusively has a drain in the corner of the rear bench where water that would collect from rain during storage is expelled through a drain channel and off the boat. This significantly reduces the potential for stains that develop in the corners over time.

Double vented gas fill

Only Tahoe has solved the issue of fuel fill splash back and slowness. Tahoe's exclusive double fuel vent allows pressure to escape so you can fill quickly with almost no splash back.

Reflective safety striping

Tahoe adds an additional level of night safety with striping that can be seen from a distance when exposed to light.

Industry's strongest double bolted motor pod assembly

.190" thickness with integrated splash fins. 2" thick aluminum sheathed transom is fully welded. The entire pod is double bolted with at least 16 3/8" bolts and supported by more

heavy-duty "C" channels crossbeams than any other pontoon boat.

Superior quality pontoon tube

.090" thickness H5052 marine aluminum alloy. Multi-baffled near each weld for maximum strength and air lock. Hand-welded to rigid standards.

The best crossbeam and deck construction

Tahoe "Deco" Series pontoon boats feature the latest in heavy-duty hull construction. 3" high, extreme thickness "C" channel crossbeams are bolted to the full riser with heavy-duty stainless bolts, nuts and washers. Then 3/4", pressure injected, lifetime

guaranteed flooring is bolted to the crossbeams using superior grade stainless steel bolts secured permanently with stainless nylock lock nuts and washers.

Strongest bow eye

Our standard equipment stainless bow eye is connected across three crossbeams with a 1/4" aluminum reinforcement strap. Excellent strength for haul-out.

Wall joints

Wall joints welded on all four sides for extra strength.



STANDARD FEATURES

25' Model – Commander Fiberglass Helm Stand Including:

- Deco design side door with storage and easy fuse access (n/a on Admiral stand)
- Level 5 dash package – high profile automotive style vinyl wrapped dash with woodgrain panels, lighted stainless toggle switches and windshield
- 4" raised platform for helmstand and drivers chair
- Lighted cup holders
- Full gauge panel featuring black sterling tachometer, voltmeter and fuel gauge
- MP3 player storage bin with smoked glass cover and plug
- Surface storage trays for cell phone and other personal items
- Seastar hydraulic easy-to-turn tilt steering
- Woodgrain steering wheel with brilliant aluminum non-directional spokes

27' Model – Admiral Fiberglass Entertainment Helm Including Above Items Plus:

- Faux Corian countertop with integrated sink, sink cover, electric faucet and two gallon water reservoir

- Electric hidden entertainment bar with wine racks, wine glasses and stainless cup holders that raises and lowers at the touch of a button
- Refrigerator – DC electric stainless steel with slide out top loading cooling compartment
- Stainless steel easy slide drawer system with friction lock

Electronics

- Garmin full color GPS with built-in inland maps, Fishfinder, water temp, depth gauge, speedometer
- Jensen MSR2107 high power waterproof stereo with 1 GB storage and memory stick input. Includes four Marine Audio high power speakers and stainless logo speaker covers
- Two 12 volt power points – helm and bow
- Reserve battery system with Start Now protection

Lighting

- SST docking lights built into front walls in heavy duty reinforced chrome housing

- Stainless amber floor mood lighting
- Lighted cup holders in rear lounges
- Bimini top light
- Stainless courtesy light on side of Admiral's stand
- USCG navigation and stern lighting

Performance

- Waveglider™ high performance pontoons – includes 25" triple pontoons and Tahoe's exclusive Waveglider™ – high performance lifting strakes and 42 gallon fuel tank for center pontoon
- Ski tow bar
- Aluminum Waveshield

Furnishings

- Plush Deco designer furnishings
- Plush dual rear reclining lounges with electric adjustable backs and plush pillows
- Plush bow bench lounge arms
- Admiral's reclining driver's chair with slide, swivel and self leveling arms

- Furnishings are created using Tahoe's exclusive heavy duty 50 ounce Matrix 50 marine upholstery. Stain, tear and puncture resistant.
- Upholstered aluminum seat frames with dry floor matting and flow through ventilation
- Portable SST cup holders

Styling

- Front radius deck with simulated teak flooring, rear deck with simulated teak flooring and twin ladders
- Exclusive Deco two tone ATI painted heavy duty solid aluminum walls
- SST retro grillwork integrated into bow and side walls
- SST front gate with smoked glass insert
- Heavy duty SST front gate latch
- SST Deco side wall air vents
- SST non-skid strips for doorways
- Upholstered decorative interior wall covering
- HI Flex bold chrome logos
- Custom Art Deco graphics package

- Plush 28 oz. Islands designer carpet

Convenience

- Trash can built in
- Smoked glass tables with wine glass holders and SST decorative cup holders. 1 petite round cocktail table rear and 1 rectangular bow
- Fire extinguisher
- Four eye straps to mount fenders
- Four stainless pop up cleats
- SST gas cap and vent
- Privacy station under rear lounge
- Portable cooler in driver's stand (25" only)

Canvas and Top

- 10' Bimini top featuring round polished aluminum frame and logo boot
- Six stainless steel easy-to-use Polished OneTouch™ quick release top locks
- Transport position support brackets for Bimini top
- Color matched full mooring cover with vented pole supports

Construction

- 8 1/2" wide
- Double full riser connections
- Exclusive side protector keels
- Heavy duty 4" reinforced deck rail with black rubber bumper
- Heavy duty 3" C-channel crossbeams

- Bolted deck with stainless bolts and lock nuts
- Stainless steel corner castings all four corners
- Extra heavy duty motor pod double bolted with 3/8" SST bolts

INTERIOR OPTIONS

VISION

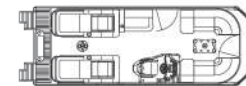

25'

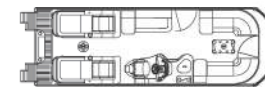

27'

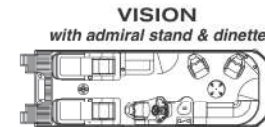

27'

OPTIONS

Wall and Furniture Color Options

- See page 47

Deck Options

- Aluminum decking

Flooring Options

- Additional simulated teak flooring – See page 46
- Vinyl flooring (except rear and bow area) (n/a on aluminum deck)
- Snap-in carpet (except rear and bow area) (upgrade to vinyl flooring also required)

Captain's Chair Options

- See pages 44 and 45

Furniture Options

- Luxury umbrella (Tan only) for table

Entertaining Options

- Stainless gas grill

Dash/Electronics Options

- Garmin 441S Coastal GPS (upgrade exchange)
- Premium sound system upgrade (six coaxial speakers, subwoofer, amp.)
- Battery dual selector switch

Lighting Options

- Rub rail multicolored light system
- Rear underwater lights

Steering Options

- Electric power assist steering

Top Options

- Second Bimini top

Performance Options

- 27" center pontoon

Watersports Options

- Waterski/wakeboard tower

Camper Enclosure Options – Factory Pre-installed Only

- See page 44

Misc. Options

- Livewell under port bow bench
- Wash down kit with sprayer and pump
- Seat covers in place of, or in addition to, mooring cover
- Docklines retractable built in

SPECIFICATIONS

LENGTH	25'	27'
Pontoon Diameter	25" x 3	25" x 3
Width	8 1/2'	8 1/2'
Dry Weight	3,700	4,400
Max. Weight Cap.	2,850	2,840
Max. Engine HP	250	300
Max. # People	12	14
Max. People Lbs.	1,910	1,900



VISION 27'



VISION 25'

Some models shown with optional equipment.



Tahoe



VISION

A RETRO DESIGN WITH ALL NEW 21ST CENTURY CONSTRUCTION!

VISION is the most revolutionary rear lounge model available. Featuring a whole new idea in wall construction that creates a seamless automotive style look. These remarkable heavy duty aluminum walls feature our exclusive Evolution™ high gloss marine quality coating, imbedded stainless steel designer accent wall grills and Deco graphics. Inside you will find the industry's only electric adjustable rear lounge seats that move to your most comfortable position at the touch of a button. Also included in the 27' model is a refrigerator, sink and electric hidden wine rack.

DECO
SERIES

VISION 27'

VISION 27'



2012
Tahoe
PONTON BOATS



STANDARD FEATURES

25' Model – Commander Fiberglass Helm

Standard Including:

- Deco design side door with storage and easy fuse access (n/a on Admiral stand)
- Level 5 dash package – high profile automotive style vinyl wrapped dash with woodgrain panels, lighted stainless toggle switches and windshield
- 4" raised platform for helmstand and drivers chair
- Lighted cup holders
- Full gauge panel featuring black sterling tachometer, voltmeter and fuel gauge
- MP3 player storage bin with smoked glass cover and plug
- Surface storage trays for cell phone and other personal items
- Baystar hydraulic easy-to-turn tilt steering
- Woodgrain steering wheel with brilliant aluminum non-directional spokes

27' & 29' Models – Admiral Fiberglass Entertainment Helm Including Above Items Plus:

- Faux Corian countertop with integrated sink, sink cover, electric faucet and two gallon water reservoir

- Electric hidden entertainment bar with wine racks, wine glasses and stainless cup holders that raises and lowers at the touch of a button
- Refrigerator – DC electric stainless steel with slide out top loading cooling compartment
- Stainless steel easy slide drawer system with friction lock

Electronics

- Garmin full color GPS with built-in inland maps, Fishfinder, water temp, depth gauge, speedometer
- Jensen MSR2107 high power waterproof stereo with 1 GB storage and memory stick input. Includes four Marine Audio high power speakers and stainless logo speaker covers
- Two 12 volt power points – helm and bow
- Reserve battery system with Start Now protection
- Exclusive fiberglass easy access dual battery box

Lighting

- SST docking lights built into front walls in heavy duty reinforced chrome housing
- Stainless amber floor mood lighting

- Engine compartment light
- Bimini top light
- Stainless courtesy light on side of helmstand
- USCG navigation and stern lighting

Furnishings

- Plush Deco designer furnishings
- Plush bow bench lounge arms
- Plush pillowed arm rests port rear bench
- Hideaway flip down cup holders built into seat back
- Admiral's reclining driver's chair with slide, swivel and self leveling arms
- Furnishings are created using Tahoe's exclusive heavy duty 50 ounce Matrix 50 marine upholstery. Stain, tear and puncture resistant.
- Upholstered aluminum seat frames with dry floor matting and flow through ventilation

Styling

- Unique front and rear radius deck with simulated teak flooring
- Unique rear radius walls
- Rear entry with simulated teak floor and swim platform ladder

- SST rear entry gate with smoked glass insert
- SST integrated wall railings elements
- Exclusive Deco two tone wall panels with 29" high 1 1/4" diameter .090" anodized railings
- SST Deco side wall air vents
- HI Flex bold chrome logos
- Custom Art Deco graphics package
- Engraved interior door panels with net
- SST non-skid strips for doorways
- Upholstered decorative interior wall covering
- Plush 28 oz. Islands designer carpet

Convenience

- Convenience center with Corian style surface, paper towel holder and storage
- Trash can built in
- Two exclusive stylish smoked glass tables with wine glass holders and stainless decorative cup holders
- Fire extinguisher
- Four eye straps to mount fenders
- Four stainless pop up cleats
- 30 gallon fuel capacity with SST gas cap and vent
- Portable cooler in helmstand (25' only)

INTERIOR OPTIONS

REAR ENTRY

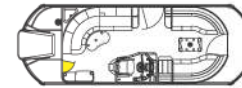

25'



27'

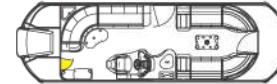

29'

ELITE

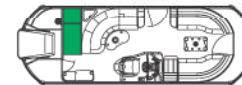

25'

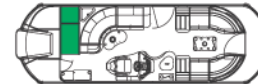

27'

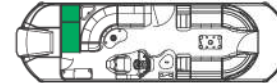

29'

OPTIONS

Wall and Furniture Color Options

- See page 47

Deck Options

- Aluminum decking

Flooring Options

- Additional simulated teak flooring – See page 46
- Vinyl flooring (except rear and bow area) (n/a on aluminum deck)
- Snap-in carpet (except rear and bow area) (upgrade to vinyl flooring also required)

Captain's Chair Options

- See pages 44 and 45

Furniture Options

- Luxury umbrella (Tan only) for table

Entertaining Options

- Stainless gas grill

Dash/Electronics Options

- Garmin 441S Coastal GPS (upgrade exchange)

- Premium sound system upgrade (six coaxial speakers, subwoofer, amp.)
- Battery dual selector switch

Lighting Options

- Rub rail multicolored light system
- Rear underwater lights

Steering Options

- Electric power assist steering (requires Sea Star upgrade)

- Sea Star hydraulic high capacity steering

Top Options

- Second Bimini top

Performance Options

- Waveglider™ high performance pontoons – see pages 16 and 17
- Aluminum Waveshield

Watersports Options

- Ski tow bar
- Waterski/wakeboard tower

Canvas and Top

- 10' Bimini top featuring round polished aluminum frame and logo boot
- Six stainless steel easy-to-use Polished OneTouch™ quick release top locks
- Transport position support brackets for Bimini top
- Color matched full mooring cover with vented pole supports

Construction

- 8 1/2" wide
- 2 – 25" diameter pontoons
- Double full riser connections
- Exclusive side protector keels
- Heavy duty 4" reinforced deck rail with black rubber bumper
- Heavy duty 3" C-channel crossbeams
- Bolted deck with stainless bolts and lock nuts
- Stainless steel corner castings all four corners
- Extra heavy duty motor pod double bolted with 3/8" SST bolts

SPECIFICATIONS

LENGTH	25'	27'	29'
Pontoon Diameter	25"	25"	25"
Width	8 1/2'	8 1/2'	8 1/2'
Dry Weight	2,450	2,650	2,850
Max. Weight Cap.	2,530	2,675	2,920
Max. Engine HP	150	175	200
Max. # People	13	14	16
Max. People Lbs.	1,790	2,030	2,270

Camper Enclosure Options – Factory Pre-installed Only

- See page 44

Misc. Options

- Livewell under port bow bench
- Wash down kit with sprayer and pump
- Seat covers in place of, or in addition to, mooring cover
- Docklines retractable built in
- Inboard/Outboard (standard only as a Waveglider™ model) see page 18

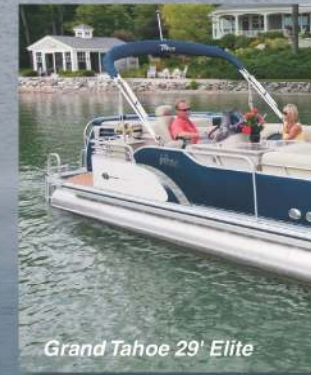

Grand Tahoe 29' Elite

Grand Tahoe 25' Elite



Tahoe PONTON BOATS

GRAND TAHOE

THE BEAUTIFUL & SPORTY GRAND TAHOE IS THE BEST EXHIBIT OF CLASS IN PONTOON BOATING

DECO
SERIES



Grand Tahoe 27' Elite

GRAND TAHOE'S Unique Deco styling features radius walls with stainless steel railing elements encompassing a fabulous, luxuriously appointed designer interior with an almost endless list of standard features. This exquisite luxury and style combined with the industry's strongest hull makes a powerful statement about the distinct character of its owner.

2012
Tahoe
PONTOON BOATS

Some models shown with optional equipment.

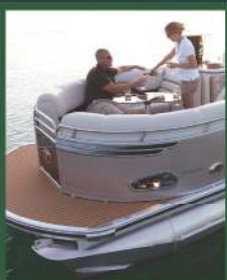

STANDARD FEATURES

Commander Fiberglass Helm Including:

- Level 5 dash package – high profile automotive style vinyl wrapped dash with woodgrain panels, lighted stainless toggle switches and windshield
- Lighted cup holders
- Full gauge panel featuring black sterling tachometer, voltmeter and fuel gauge
- MP3 player storage bin with smoked glass cover and plug
- Surface storage trays for cell phone and other personal items
- Baystar hydraulic easy-to-turn tilt steering
- Woodgrain steering wheel with brilliant aluminum non-directional spokes
- Deco design side door with storage and easy fuse access

Electronics

- Garmin full color GPS with built-in inland maps, Fishfinder water temp, depth gauge, speedometer

- Jensen MSR2107 high power waterproof stereo with 1 GB storage and memory stick input. Includes four Marine Audio high power speakers and stainless logo speaker cover.
- Two 12 volt power points – helm and bow
- Exclusive fiberglass easy access dual battery box

Lighting

- SST docking lights built into front walls in heavy duty reinforced chrome housing
- Stainless amber floor mood lighting
- Engine compartment light
- Bimini top light
- Stainless courtesy light on side of helmstand
- USCG navigation and stern lighting

Furnishings

- Plush radius designer furnishings
- Plush deluxe lounge arms

- Admiral's reclining driver's chair with slide, swivel and self leveling arms
- Furnishings are created using Tahoe's exclusive heavy duty 50 ounce Matrix 50 marine upholstery. Stain, tear and puncture resistant.
- Upholstered aluminum seat frames with dry floor matting and flow through ventilation
- Portable SST cup holders

Styling

- SST front gate with smoked glass insert
- Rear entry with simulated teak floor and swim platform ladder
- SST rear entry gate with smoked glass insert
- Exclusive Deco two tone wall panels with 29" high 1 1/4" diameter .090" anodized railings
- SST Deco polished wall element
- SST Deco side wall air vents
- HI Flex bold chrome logos

- Custom Art Deco graphics package
- Engraved interior door panels with net
- Stainless steel non-skid strips for doorways
- Plush 28 oz. Islands carpet
- Radius front deck

Convenience

- Portable cooler in helmstand
- Trash can built in
- Deluxe wine rack with ice carafe built in
- Exclusive stylish curved smoked glass table with wine glass holders and stainless decorative cup holders
- Fire extinguisher
- Four eye straps to mount fenders
- Four stainless pop up cleats
- 30 gallon fuel capacity with SST gas cap and vent

Canvas and Top

- 10' Bimini top featuring round polished aluminum frame and logo boot

- Six stainless steel easy-to-use Polished OneTouch™ quick release top locks
- Transport position support brackets for Bimini top
- Color matched full mooring cover with vented pole supports

Construction

- 8 1/2' wide
- 2 – 25" diameter pontoons
- Double full riser connections
- Exclusive side protector keels
- Heavy duty 4" reinforced deck rail with black rubber bumper
- Heavy duty 3" C-channel crossbeams
- Bolted deck with stainless bolts and lock nuts
- Stainless steel corner castings all four corners
- Extra heavy duty motor pod double bolted with 3/8" SST bolts

SPECIFICATIONS

LENGTH	21'	23'	25'	27'
Pontoon Diameter	25"	25"	25"	25"
Width	8 1/2'	8 1/2'	8 1/2'	8 1/2'
Dry Weight	1,850	2,240	2,450	2,650
Max. Weight Cap.	2,035	2,150	2,530	2,675
Max. Engine HP	115	125	150	175
Max. # People	10	11	13	14
Max. People Lbs.	1,300	1,540	1,790	2,030

INTERIOR OPTIONS

SIERRA CRUISE

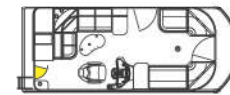

21'

SIERRA REAR ENTRY

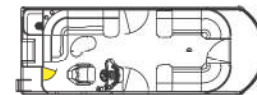

23'

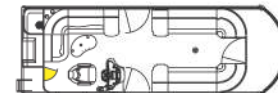

25'

SIERRA ELITE

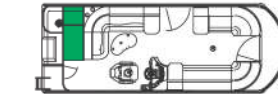

23'

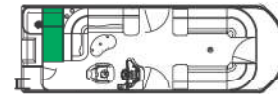

25'

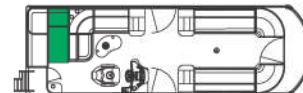

27'

OPTIONS

Wall and Furniture Color Options

- See page 47

Deck Options

- Aluminum decking

Flooring Options

- Additional simulated teak flooring – See page 46
- Vinyl flooring (n/a on aluminum deck)
- Snap-in carpet (upgrade to vinyl flooring also required)

Captain's Chair Options

- See pages 44 and 45

Entertaining Options

- Refreshment center COMMANDER in place of lounge arm with sink, electric faucet, two gallon water reservoir, trash can liner and stainless drawer with ice cube cooler
- Convenience center with Corian style surface, paper towel holder and storage (Elite interior only)
- Refrigerator – DC electric stainless steel with slide out top loading cooling compartment in special housing with Corian style surface
- Stainless gas grill

Dash/Electronics Options

- Garmin 441S Coastal GPS (upgrade exchange)
- Premium sound system upgrade (six coaxial speakers, subwoofer, amp.)
- Reserve battery system with Start Now protection
- Battery dual selector switch

Lighting Options

- Rub rail multi-colored light system
- Rear underwater lights

Steering Options

- Electric power assist steering (requires Sea Star upgrade)
- Sea Star hydraulic high capacity steering

Top Options

- Second Bimini top

Performance Options

- Waveglider™ high performance pontoons – see pages 16 and 17
- Aluminum Waveshield

Watersports Options

- Ski tow bar
- Waterski/wakeboard tower

Camper Enclosure Options – Factory Pre-installed Only

- See page 44

Misc. Options

- 4" raised platform for helmstand and drivers chair
- Livewell under port bow bench
- Wash down kit with sprayer and pump
- Seat covers in place of, or in addition to, mooring cover
- Docklines retractable built in
- Inboard/Outboard (standard only as a Waveglider™ model) see page 18



Sierra 23' Elite

Tahoe PONTON BOATS

SIERRA

A LEGEND IN TOP OF THE LINE PONTOON BOATS



Sierra 25' Elite

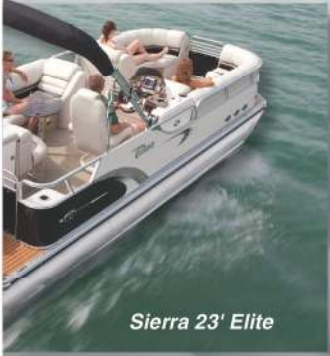

Sierra 23' Elite

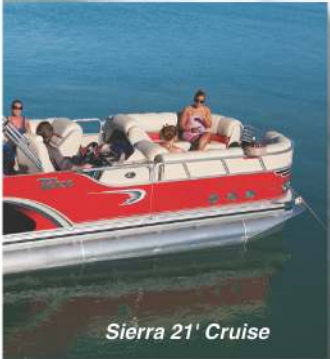

Sierra 21' Cruise

For years the Tahoe **SIERRA** has been praised for its magnificent form and function. Now with the evolution of DECO styling, Sierra is the fabulous unmatched choice for a top of the line, classic layout, pontoon boat. Stainless wall elements, vented seat compartments, plush furniture, and more features than any other brand will give you a pride of ownership you can't find anywhere else.

Some models shown with optional equipment.

2012
Tahoe
PONTOON BOATS



STANDARD FEATURES

Commander Fiberglass Helm Including:

- Level 5 dash package – high profile automotive style vinyl wrapped dash with woodgrain panels, lighted stainless toggle switches and windshield
- Lighted cup holders
- Full gauge panel featuring black sterling tachometer, voltmeter and fuel gauge
- MP3 player storage bin with smoked glass cover and plug
- Surface storage trays for cell phone and other personal items
- Baystar hydraulic easy-to-turn tilt steering
- Woodgrain steering wheel with brilliant aluminum non-directional spokes
- Deco design side door with storage and easy fuse access

Electronics

- Garmin full color GPS with built-in inland maps, Fishfinder water temp, depth gauge, speedometer

- Jensen MSR2107 high power waterproof stereo with 1 GB storage and memory stick input. Includes four Marine Audio high power speakers and stainless logo speaker covers.
- Two 12 volt power points – helm and bow
- Exclusive fiberglass easy access dual battery box

Lighting

- SST docking lights built into front walls in heavy duty reinforced chrome housing
- Stainless amber floor mood lighting
- Engine compartment light
- Bimini top light
- Stainless courtesy light on side of helmstand
- USCG navigation and stern lighting

Furnishings

- Plush designer furnishings
- Plush deluxe lounge arms
- Admiral's reclining driver's chair with slide, swivel and self leveling arms
- 2 bow commander reclining chairs with slide, swivel and self leveling arms

- Bow umbrella with exclusive round smoked glass cocktail table with wine glass holders
- Furnishings are created using Tahoe's exclusive heavy duty 50 ounce Matrix 50 marine upholstery. Stain, tear and puncture resistant.
- Upholstered aluminum seat frames with dry floor matting and flow through ventilation
- Portable SST cup holders

Styling

- Front fishing height radius walls
- SST front gate with smoked glass insert
- Rear entry with simulated teak floor and swim platform ladder
- SST rear entry gate with smoked glass insert
- Exclusive Deco two tone wall panels with 29" high 1 1/4" diameter .090" anodized railings
- SST Deco polished wall element
- SST Deco side wall air vents
- HI Flex bold chrome logos
- Custom Art Deco graphics package

- Engraved interior door panels with net
- Stainless steel non-skid strips for doorways
- Plush 28 oz. Islands carpet
- Radius front deck

Convenience

- Portable cooler in helmstand
- Trash can built in
- Deluxe wine rack with ice carafe built in
- Exclusive stylish curved smoked glass table with wine glass holders and stainless decorative cup holders
- Fire extinguisher
- Four eye straps to mount fenders
- Four stainless pop up cleats
- 30 gallon fuel capacity with SST gas cap and vent

Canvas and Top

- 10' Bimini top featuring round polished aluminum frame and logo boot
- Six stainless steel easy-to-use Polished OneTouch™ quick release top locks

- Transport position support brackets for Bimini top
- Color matched full rising cover with vented pole supports

INTERIOR OPTIONS

SIERRA RC RE

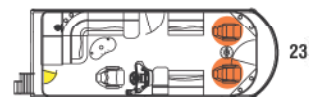

SIERRA RC ELITE

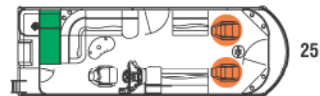

OPTIONS

Wall and Furniture Color Options

- See page 47

Deck Options

- Aluminum decking

Flooring Options

- Additional simulated teak flooring – See page 46
- Vinyl flooring (n/a on aluminum deck)
- Snap-in carpet (upgrade to vinyl flooring also required)

Captain's Chair Options

- See pages 44 and 45

Entertaining Options

- Refreshment center COMMANDER in place of lounge arm with sink, electric faucet, two gallon water reservoir, trash can liner and stainless drawer with ice cube cooler
- Convenience center with Corian style surface, paper towel holder and storage (Elite interior only)
- Refrigerator – DC electric stainless steel with slide out top loading cooling compartment in special housing with Corian style surface
- Stainless gas grill

Dash/Electronics Options

- Garmin 441S Coastal GPS (upgrade exchange)
- Premium sound system upgrade (six coaxial speakers, subwoofer, amp.)
- Reserve battery system with Start Now protection
- Battery dual selector switch

Lighting Options

- Rub rail multi-colored light system
- Rear underwater lights

Steering Options

- Electric power assist steering (requires Sea Star upgrade)
- Sea Star hydraulic high capacity steering

Top Options

- Second Bimini top

Performance Options

- Waveglider™ high performance pontoons – see pages 16 and 17
- Aluminum Waveshield

Watersports Options

- Ski tow bar
- Waterski/wakeboard tower

Camper Enclosure Options – Factory Pre-installed Only

- See page 44

Misc. Options

- 4" raised platform for helmstand and drivers chair
- Livewell under port bow bench

SPECIFICATIONS

LENGTH	23'	25'
Pontoon Diameter	25"	25"
Width	8 1/2'	8 1/2'
Dry Weight	2,240	2,450
Max. Weight Cap.	2,150	2,530
Max. Engine HP	125	150
Max. # People	11	13
Max. People Lbs.	1,540	1,790

- Wash down kit with sprayer and pump
- Seat covers in place of, or in addition to, mooring cover
- Docklines retractable built in
- Inboard/Outboard (standard only as a Waveglider™ model) see page 18

Sierra RC 25' Elite

Sierra RC 23' Cruise

Some models shown with optional equipment

Tahoe PONTON BOATS

SIERRA RC

ROMANTIC RELAXATION

You will cherish your **SIERRA RC** as the place to surround yourself with the luxurious DECO design and construction combined with a front relaxation area featuring two reclining chairs, a cocktail table, and umbrella.

DECO
SERIES

Sierra RC 25' Elite

2012
Tahoe
PONTON BOATS



STANDARD FEATURES

Commander Fiberglass Helm Including:

- Level 5 dash package – high profile automotive style vinyl wrapped dash with woodgrain panels, lighted stainless toggle switches and windshield
- Lighted cup holders
- Full gauge panel featuring black sterling tachometer, voltmeter and fuel gauge
- MP3 player storage bin with smoked glass cover and plug
- Surface storage trays for cell phone and other personal items
- Sea Star hydraulic easy-to-turn tilt steering
- Woodgrain steering wheel with brilliant aluminum non-directional spokes
- Deco design side door with storage and easy fuse access

Electronics

- Garmin full color GPS with built-in inland maps, Fishfinder water temp, depth gauge, speedometer

- Jensen MSR2107 high power waterproof stereo with 1 GB storage and memory stick input. Includes four Marine Audio high power speakers and stainless logo speaker covers.
- Two 12 volt power points – helm and bow
- Reserve battery system with Start Now protection
- Exclusive fiberglass easy access dual battery box

Lighting

- Docking lights built into front walls in heavy duty reinforced housing
- Stainless amber floor mood lighting
- Engine compartment light
- Ceiling light
- Stainless courtesy light on side of helmstand
- USCG navigation and stern lighting

Performance

- Waveglider™ system – high performance pontoons – includes 25" triple pontoons and Tahoe's exclusive Waveglider™ – high performance lifting strakes and 42 gallon fuel tank for center pontoon
- Ski tow bar

Furnishings

- Plush radius designer furnishings
- Plush deluxe lounge arms
- Admiral's reclining driver's chair with slide, swivel and self leveling arms
- Furnishings are created using Tahoe's exclusive heavy duty 50 ounce Matrix 50 marine upholstery. Stain, tear and puncture resistant.
- Upholstered aluminum seat frames with dry floor matting and flow through ventilation
- Portable SST cup holders

Funship Special Equipment

- Deluxe 10' walk-on sun roof with rear ladder, Waterpark™ slide with waterfall water pump, decorative walls, king size upper deck lounge with backs and cushions, upper deck entertainment center with remote, stereo controls, two speakers and storage
- Convenience center starboard rear with Corian style surface, paper towel holder and storage

Styling

- Front radius walls
- Radius front deck
- SST front gate with smoked glass insert
- Rear entry with simulated teak floor and swim platform ladder
- SST rear entry gate with smoked glass insert
- Exclusive Deco two tone wall panels with 29" high 1 1/4" diameter .090" anodized railings
- SST Deco side wall air vents
- HI Flex bold chrome logos
- Custom Art Deco graphics package
- Engraved interior door panels with net
- Stainless steel non-skid strips for doorways
- Plush 28 oz. Islands carpet

Convenience

- Portable cooler in helmstand
- Trash can built in
- Deluxe wine rack with ice carafe built in

- Exclusive stylish curved smoked glass table with wine glass holder and stainless decorative cup holders
- Fire extinguisher
- Four eye straps to mount fenders
- Four stainless pop up cleats

Canvas

- Color matched full mooring cover with vented pole supports

Construction

- 8 1/2" wide
- Double full riser connections
- Exclusive side protector keels
- Heavy duty 4" reinforced deck rail with black rubber bumper
- Heavy duty 3" C-channel crossbeams
- Bolted deck with stainless bolts and lock nuts
- Stainless steel corner castings all four corners

INTERIOR OPTIONS

SIERRA FUNSHIP

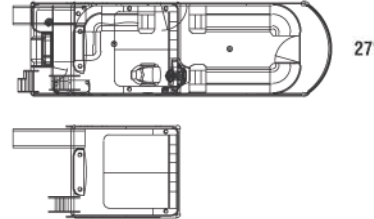

OPTIONS

Wall and Furniture Color Options

- See page 47

Deck Options

- Aluminum decking

Flooring Options

- Additional simulated teak flooring – See page 46
- Vinyl flooring (n/a on aluminum deck)
- Snap-in carpet (upgrade to vinyl flooring also required)

Captain's Chair Options

- See pages 44 and 45

Furniture Options

- Luxury umbrella (Tan only) with round smoked glass table

Entertaining Options

- Refreshment center COMMANDER in place of lounge arm with sink, electric faucet, two gallon water reservoir, trash can liner and stainless drawer with ice cube cooler
- Refrigerator – DC electric stainless steel with slide out top loading cooling compartment in special housing with Corian style surface
- Stainless gas grill

Dash/Electronics Options

- Garmin 441S Coastal GPS (upgrade exchange)
- Premium sound system upgrade (six coaxial speakers, subwoofer, amp.)

- Battery dual selector switch
- Premium sound system upgrade (six coaxial speakers, subwoofer, amp.)

Lighting Options

- Rub rail multi-colored light system
- Rear underwater lights

Steering Options

- Electric power assist steering

Top Options

- Bimini top for upper roof
- Front Bimini top – factory pre-installed only

Performance Options

- Aluminum Waveshield

Watersports Options

- Ski tow bar

Camper Enclosure Options – Factory Pre-installed Only

- See page 44

Misc. Options

- 4" raised platform for helmstand and drivers chair
- Livewell under port bow bench
- Wash down kit with sprayer and pump
- Seat covers in place of, or in addition to mooring cover
- Docklines retractable built in
- Inboard/Outboard (standard only as a Waveglider™ model) see page 18

SPECIFICATIONS

PONTOON LENGTH	27'
Pontoon Diameter	25" x 3
Width	8 1/2'
Dry Weight	3,950
Max. Wt. Cap.	3,110
Max. Engine HP	250
Max. No. People	15
Max. People Lbs.	2,100



Some models shown with optional equipment.

Tahoe PONTON BOATS

SIERRA FUNSHIP

A WATER PARK ON THE WATER!

DECO
SERIES

Have the best of family fun every weekend with the all new **SIERRA FUNSHIP**.

Loaded with standard features to make a day on the water complete. Slide, swim, lounge, entertain and even water-ski with the standard triple Waveglider™ high performance pontoons. Do it all – and do it all at once – on the Funship!



Sierra Funship 27' Elite

2012
Tahoe
PONTON BOATS



STANDARD FEATURES

Commander Fiberglass Helm Including:

- Level 5 dash package – high profile automotive style vinyl wrapped dash with woodgrain panels, lighted stainless toggle switches and windshield
- Lighted cup holders
- Full gauge panel featuring black sterling tachometer, voltmeter and fuel gauge
- MP3 player storage bin with smoked glass cover and plug
- Surface storage trays for cell phone and other personal items
- Sea Star hydraulic easy-to-turn tilt steering
- Woodgrain steering wheel with brilliant aluminum non-directional spokes
- Deco design side door with storage and easy fuse access

Electronics

- Garmin full color GPS with built-in inland maps, Fishfinder water temp, depth gauge, speedometer
- Jensen MSR2107 high power waterproof stereo with 1 GB storage and memory stick input. Includes four Marine Audio high power speakers and stainless logo speaker covers.

- Two 12 volt power points – helm and bow
- Reserve battery system with Start Now protection

Lighting

- SST docking lights built into front walls in heavy duty reinforced chrome housing
- Stainless amber floor mood lighting
- Bimini top light
- Stainless courtesy light on side of helmstand
- USCG navigation and stern lighting

Performance

- Waveglider™ system – high performance pontoons – includes 25" triple pontoons and Tahoe's exclusive Waveglider™ – high performance lifting strakes and 42 gallon fuel tank for center pontoon
- Ski tow bar

Furnishings

- Plush radius designer furnishings
- Plush deluxe lounge arms
- Admiral's reclining driver's chair with slide, swivel and self leveling arms
- Starboard radius bow bench

- Port bow dinette with Commander reclining chairs with slide, swivel and self leveling arms

- Umbrella with exclusive stylish round smoked glass table with wine glass holders and stainless decorative cup holder

- Port side bench

- Port privacy station

- Furnishings are created using Tahoe's exclusive heavy duty 50 ounce Matrix 50 marine upholstery. Stain, tear and puncture resistant.

- Upholstered aluminum seat frames with dry floor matting and flow through ventilation
- Portable SST cup holders

Entertainment Areas

- Culinary center including: Refrigerator – DC electric stainless steel with slide out top loading cooling compartment in special housing with Corian style surface
- Stainless steel gas grill
- Refreshment center COMMANDER with sink, electric SST faucet, two gallon water reservoir, trash can liner and stainless drawer

- Large rear swim platform area with simulated teak non-skid flooring

- One port and one starboard rear swim platform ladder

- Rear bar and music center includes cup holders, remote stereo controls, 12 volt outlet, storage and cube cooler

- Two rear Sandbar recliner chairs with footrest

- Exclusive stylish round smoked glass cocktail table with wine glass holders and stainless decorative cup holder

- Telescoping flag pole with American flag

Styling

- Front radius walls
- Radius front deck
- SST front gate with smoked glass insert
- Exclusive Deco two tone wall panels with 29" high 1 1/4" diameter .090" anodized railings SST Deco polished wall element
- SST Deco side wall air vents
- HI Flex bold chrome logos
- Custom Art Deco graphics package

- Engraved interior door panels with net
- Stainless steel non-skid strips for doorways
- Plush 28 oz. Islands carpet

Convenience

- Portable cooler in helmstand
- Fire extinguisher
- Four eye straps to mount fenders
- Four stainless pop up cleats

Canvas and Top

- 10' Bimini top featuring round polished aluminum frame and logo boot
- Six stainless steel easy-to-use Polished OneTouch™ quick release top locks

- Transport position support brackets for Bimini top
- Color matched full mooring cover with vented pole supports

Construction

- 8 1/2" wide
- Double full riser connections
- Exclusive side protector keels
- Heavy duty 4" reinforced deck rail with black rubber bumper
- Heavy duty 3" C-channel crossbeams
- Bolted deck with stainless bolts and lock nuts
- Stainless steel corner castings all four corners
- Extra heavy duty motor pod integrated into center pontoon

INTERIOR OPTIONS

SIERRA SANDBAR

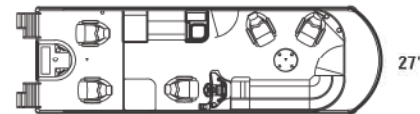

OPTIONS

Wall and Furniture Color Options

- See page 47

Deck Options

- Aluminum decking

Flooring Options

- Additional simulated teak flooring – See page 46
- Vinyl flooring (n/a on aluminum deck)
- Snap-in carpet (upgrade to vinyl flooring also required)

Captain's Chair Options

- See pages 44 and 45

Dash/Electronics Options

- Garmin 441S Coastal GPS (upgrade exchange)
- Premium sound system upgrade (six coaxial speakers, subwoofer, amp.)
- Battery dual selector switch

Lighting Options

- Rub rail multi-colored light system
- Rear underwater lights

Steering Options

- Electric power assist steering

Top Options

- Bimini top for upper roof
- Front Bimini top

Performance Options

- Aluminum Waveshield

Watersports Options

- Waterski/wakeboard tower

Camper Enclosure Options – Factory Pre-installed Only

- See page 44

Misc. Options

- 4" raised platform for helmstand and drivers chair
- Livewell under port bow bench
- Wash down kit with sprayer and pump
- Seat covers in place of, or in addition to, mooring cover
- Docklines retractable built in
- Inboard/Outboard (standard only as a Waveglider™ model) see page 18
- ATI solid painted Vision style Deco walls with stainless grillwork

SPECIFICATIONS

PONTOON LENGTH	27'
Pontoon Diameter	25" x 3
Width	8 1/2'
Dry Weight	3,300
Max Weight Cap.	3,200
Max. Engine HP	300
Max. # People	15
Max. Persons Lbs.	2,350



Sierra Sandbar 27' with ATI walls

Some models shown with optional equipment.

Tahoe PONTOON BOATS

SIERRA SANDBAR

RAISE YOUR FLAG!

DECO
SERIES

Race to your favorite beach or cove on **SANDBAR'S** standard Waveglider™ triple pontoons! Then raise your flag and spend the day enjoying your Sierra Sandbar from end to end for swimming, listening to tunes, lounging and partying at the rear bar!



Sierra Sandbar 27' with ATL walls

2012
Tahoe
PONTON BOATS



WAVEGLIDER™ HIGH PERFORMANCE PACKAGES

**WAVEGLIDER™ HIGH PERFORMANCE SYSTEM
PROVEN PERFORMANCE
AND DURABILITY!**



Tahoe has tested our High Performance System on trips from Baltimore to Key West, across Lake Michigan and across the ocean from Ft. Lauderdale to



Bimini in the Bahamas, and Key West to the Dry Tortugas. So you can be assured of one tough, high performance boat. So go ahead and turn your boat into the fast planing sport boat you want. It will be a blast to drive, a great all around family boat and perfect for pulling skiers, tubes and wakeboards.*

Waveglider™ High Performance System – 23" or 25" diameter triple pontoons, high performance lifting strakes, Sea Star hydraulic steering and 42 gallon fuel tank for center pontoon.



Waveglider™ with aluminum waveshield



**WAVEGLIDER™
WATERSPORTS PACKAGE**

Waveglider™ Watersports package includes Waveglider™ High Performance System – plus: ski tow bar and aluminum waveshield.



Some models shown with optional equipment.



Tahoe PONTON BOATS

WAVEGLIDER™ SPECIFICATIONS

Boat Size	Pontoon Length	Pontoon Diameter	Deck Width	Dry Weight	Maximum Weight Capacity	Maximum Engine	Maximum Number Persons	Maximum Passenger Weight
DECO SERIES								
VISION								
27'	27'	3-25"	8.5'	4,400	2,840	300	14	1,900
25'	25'	3-25"	8.5'	3,700	2,850	250	12	1,910
GRANDTAHOE								
29'	29'	3-25"	8.5'	3,500	3,415	300	19	2,645
27'	27'	3-25"	8.5'	3,300	3,200	300	17	2,350
25'	25'	3-25"	8.5'	3,100	2,910	250	14	2,050
SIERRA								
27'	27'	3-25"	8.5'	3,300	3,200	300	17	2,350
25'	25'	3-25"	8.5'	3,100	2,910	250	14	2,250
23'	23'	3-25"	8.5'	2,900	2,620	225	12	1,800
21'	21'	3-25"	8.5'	2,250	2,365	175	12	1,740
SIERRA RC								
25'	25'	3-25"	8.5'	3,100	2,910	250	14	2,050
23'	23'	3-25"	8.5'	2,900	2,620	225	12	1,800
SIERRA FUNSHIP								
27'	27'	3-25"	8.5'	3,950	3,110	250	15	2,100
SIERRA SANDBAR								
27'	27'	3-25"	8.5'	3,300	3,200	300	15	2,350
C SERIES								
VISTA CTS 25" DIAMETER								
26'	26'	3-25"	8.5'	3,125	3,200	300	17	2,400
24'	24'	3-25"	8.5'	3,000	2,850	250	15	2,080
22'	22'	3-25"	8.5'	2,800	2,650	225	12	1,780
20'	20'	3-25"	8.5'	2,200	2,460	175	12	1,720
VISTA RC								
24'	24'	3-25"	8.5'	3,000	2,850	250	15	2,080
22'	22'	3-25"	8.5'	2,800	2,650	225	12	1,780
VISTA RL								
26'	26'	3-25"	8.5'	3,125	3,200	300	17	2,400
24'	24'	3-25"	8.5'	3,000	2,850	250	15	2,080
VISTA FUNSHIP								
26'	26'	3-25"	8.5'	3,850	2,990	250	16	2,190
24'	24'	3-25"	8.5'	3,750	2,665	225	14	1,910
VISTA SANDBAR CTS								
26'	26'	3-25"	8.5'	3,125	3,200	300	15	2,400
BLUE RIDGE								
24'	24'	3-25"	8.5'	3,000	2,850	250	15	2,080
22'	22'	3-25"	8.5'	2,800	2,650	225	12	1,780
C-FISH								
24'	24'	3-25"	8.5'	3,000	2,850	250	15	2,080
22'	22'	3-25"	8.5'	2,800	2,650	225	12	1,780
20'	20'	3-25"	8.5'	2,200	2,460	175	12	1,720
18'	18'	3-25"	8.5'	1,950	2,100	115	10	1,440
A SERIES								
CASCADE 23" DIAMETER								
24'	24'	3-23"	8'	2,800	2,520	200	13	1,810
22'	22'	3-23"	8'	2,600	2,265	150	11	1,560
20'	20'	3-23"	8'	2,150	2,080	135	10	1,400
18'	18'	3-23"	8'	1,875	1,850	100	9	1,290
16'	16'	3-23"	8'	1,600	1,650	75	8	1,100
CASCADE 25" DIAMETER								
24'	24'	3-25"	8.5'	3,000	2,850	250	15	2,080
22'	22'	3-25"	8.5'	2,800	2,650	225	12	1,780
20'	20'	3-25"	8.5'	2,200	2,460	175	12	1,720
18'	18'	3-25"	8.5'	1,950	2,100	115	10	1,440
16'	16'	3-25"	8.5'	1,700	1,860	90	9	1,300
CASCADE DRL 25" DIAMETER								
24'	24'	3-25"	8.5'	3,000	2,850	250	15	2,080
22'	22'	3-25"	8.5'	2,800	2,650	225	12	1,780
A FISH 23" DIAMETER								
24'	24'	3-23"	8'	2,800	2,520	200	13	1,810
22'	22'	3-23"	8'	2,600	2,265	150	11	1,560
20'	20'	3-23"	8'	2,150	2,080	135	10	1,400
18'	18'	3-23"	8'	1,875	1,850	100	9	1,290
A FISH 25" DIAMETER								
24'	24'	3-25"	8'	3,000	2,850	250	15	2,080
22'	22'	3-25"	8'	2,800	2,650	225	12	1,780
20'	20'	3-25"	8'	2,200	2,460	175	12	1,720
18'	18'	3-25"	8'	1,950	2,100	115	10	1,440
SPORT								
16'	16'	3-23"	7'	1,600	1,650	75	8	1,100
14'	14'	3-23"	7'	1,400	1,360	60	6	840

WAVEGLIDER™ 5X7 TURNING PACKAGE

Take it to the next level by equipping your craft with the Tahoe Waveglider™ 5 X 7 High Performance Turning Package. For O/B models it includes the Waveglider™ Watersports package with 25" outside pontoons PLUS an upgrade to a 27" diameter Waveglider™ center pontoon and electric power assist steering for sharper turns! Just add a 27" center pontoon on an I/O to go 5 X 7!



Note - 5X7 Package is not available on Funship models or any model with a walk on sunroof.

WAVEGLIDER HIGH PERFORMANCE

INBOARD/OUTBOARD

DECO SERIES ONLY

I/O Mercruiser – Deco Series only includes: standard 350 MAG MPI 300 HP Sterndrive with Bravo III outdrive, twin stainless steel propellers, Corsa Captain's choice exhaust, Waveglider™ High Performance System 25" dia. triple pontoons, high performance lifting strakes, Sea Star hydraulic steering, and 42 gallon fuel tank for center pontoon, power assist steering, ski tow bar I/O, bilge pump, additional oil and temp gauge, exhaust blower and aluminum waveshield.

Optional Rear Swim Platform

Corsa Through Hull Exhaust

Tahoe

Power Assist Steering



Aluminum Waveshield



Some models shown with optional equipment.

Tahoe PONTON BOATS

WATERSPORT OPTIONS



BLACK FIRE GRAPHIC PACKAGE



PERFORMANCE OPTIONS

Rough Water Package

(factory installed only for Waveglider™ and 5 X 7) – suggested when boat is going to be consistently exposed to very rough water. Adds extra welding and extreme duty riser components

Aluminum Waveshield

(factory installed only) – prevents water from hitting crossbeams and under side of deck while underway

WATERSPORTS OPTIONS

Ski Tow Bar – allows convenient towing for skiers and tubes

Waterski/Wakeboard Tower – 8.5' wide only (Includes SS Bimini top) provides preferred elevation of the ski pylon for wakeboarders and advanced skiers.*

TOWER OPTIONS

- High power speakers with microphone
- Spotlight
- Tower racks (four pieces – two sides)

High performance options are available factory installed only!



In Floor Storage Compartment – factory installed only in center pontoon models



Power Assist Steering – Add power assist steering to give your boat even better handling and turning capability – requires upgrade to Sea Star Hydraulic steering



*Please follow all safety rules when towing watersports equipment. Do not overload ski tow bar or Waterski/wakeboard tower.

STANDARD FEATURES

Helmsman Fiberglass Stand

- Level 3 helm package – automotive style vinyl wrapped dash with woodgrain panels, lighted stainless toggle switches, quick release windshield, smoked glass side door, 25 qt. cooler, removable stand access panel and glove box
- Full gauge panel featuring black sterling tachometer, voltmeter and fuel gauge
- Surface storage trays for cell phone and other personal items
- Woodgrain tilt steering wheel with brilliant aluminum non-directional spokes

Electronics

- Jensen high power MSR3007 CD stereo with MP3 plug
- Four Jensen high power speakers with platinum speaker covers
- 12 volt power point

Lighting

- Docking lights built into front walls in heavy duty reinforced housing
- Stainless courtesy light on side of helmstand
- USCG navigation and stern lighting

Furnishings

- Furnishings are created using exclusive Matrix 50 marine upholstery

- Upholstered aluminum seat frames with dry floor matting and flow through ventilation
- Plated plush radius designer furnishings
- Plush deluxe lounge arms
- Commander reclining driver's chair with slide, swivel and self leveling arms
- Portable cup holders

Styling

- Front radius wall railings
- Rear entry gate with swim platform rear entry ladder
- External wall skins with 29" high 1 1/4" diameter .090" anodized railings
- Hidden wall seams
- Non-skid strips for doorways

- Plush 28 oz. Escalade Hi-Lo carpet
- Deluxe graphics package
- Three dimensional raised logos

Convenience

- Fire extinguisher
- Four stainless cleat and lifting eye assembly
- 24 gallon fuel capacity
- Thermoform curved table with locking floor base
- Privacy station - Elite and Cruise only

Canvas and Top

- 10' Bimini top with logo boot
- Transport position support brackets
- Brushed OneTouch™ quick release top locks

- Color matched full mooring cover with vented pole supports

Construction

- 8 1/2" wide
- Two - 25" diameter pontoons
- Double full riser connections
- Heavy duty 3" reinforced deck rail with rubber bumper
- Heavy duty C-channel crossbeams
- 16" OC crossbeam spacing
- Corner castings all four corners
- Extra heavy duty motor pod double bolted with 3/8" SST bolts attached to seven crossbeams
- Gate latches with stainless steel insert and welded safety tab

INTERIOR OPTIONS

VISTA CRUISE

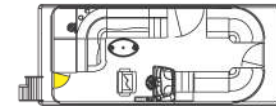

20'

VISTA REAR ENTRY

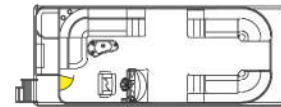

22'

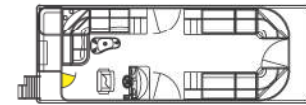

24'

VISTA ELITE

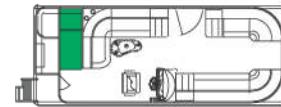

22'

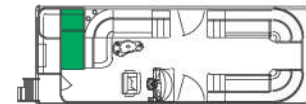

24'

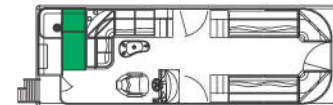

26'

OPTIONS

Wall and Furniture Color Options

- See page 47

Deck Options

- Aluminum decking

Flooring Options

- Simulated teak flooring – See page 46
- Vinyl flooring (n/a on aluminum deck)
- Snap-in carpet (upgrade to vinyl flooring also required)
- Plush 28 oz. Islands carpet

Captain's Chair Options

- See pages 44 and 45

Furniture Options

- Table options – see pages 44, 45 and 46
- Luxury umbrella for table (Tan only)

Entertaining Options

- Refreshment center COMMANDER in place of lounge arm with sink, electric faucet, two gallon water reservoir, trash can liner and stainless drawer with ice cube cooler

- Convenience center with Corian style surface, paper towel holder and storage (Elite interior only)

- Refrigerator – DC electric stainless steel with slide out top loading cooling compartment in special housing with Corian style surface
- Stainless gas grill

Dash/Electronics Options

- Fishfinder – GPS options – see page 44
- Premium sound system upgrade (six coaxial speakers, subwoofer, amp.)
- Jensen MSR2107 high power waterproof stereo with 1 GB storage and memory stick input (exchange)
- Additional Jensen speakers
- Marine Audio speakers upgrade
- Stainless logo speaker covers (requires M.A. speaker)
- Exclusive fiberglass easy access dual battery box (Elite, RE only)

- Reserve battery system with Start Now protection
- Battery dual selector switch

Lighting Options

- Rear underwater lights
- Stainless amber floor mood lighting
- Engine compartment light

Steering Options

- Baystar hydraulic easy-to-turn tilt steering
- Sea Star hydraulic steering for motors over 150 hp
- Electric power assist steering (requires Sea Star upgrade)

Top Options

- Second Bimini top

Performance Options

- Waveglider™ high performance pontoons – see pages 16 and 17
- Aluminum Waveshield

Watersports Options

- Ski tow bar
- Waterski/wakeboard tower

Camper Enclosure Options – Factory Pre-installed Only

- See page 44

Misc. Options

- 4" raised platform for helmstand and drivers chair
- Exclusive side protector keels
- Livewell under port bow bench

- Wash down kit with sprayer and pump
- Seat covers in place of, or in addition to, mooring cover
- Docklines retractable built in
- Trash can built into lounge arm
- Wine rack built in to lounge arm

SPECIFICATIONS

LENGTH	20'	22'	24'	26'
Pontoon Diameter	25"	25"	25"	25"
Width	8 1/2'	8 1/2'	8 1/2'	8 1/2'
Dry Weight	1,800	2,050	2,250	2,475
Max. Weight Cap.	2,130	2,260	2,600	2,840
Max. Engine HP	115	125	150	175
Max. # People	10	11	13	14
Max. People Lbs.	1,380	1,600	1,850	2,000



Vista 22' Elite



Tahoe PONTON BOATS

VISTA

MORE THAN YOU EXPECTED!

C
SERIES

Vista 24' Elite

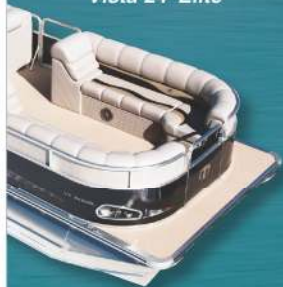

Vista 20' Cruise



The classic beauty and versatile design of the luxurious **VISTA** is great for those who desire a classic design, high quality, cruiser or a transformed model that can be a high powered family sport boat that will be more than you are used to and way more than you expected!

Vista 22' Elite



2012
Tahoe
PONTON BOATS

Some models shown with optional equipment.



STANDARD FEATURES

Helmman Fiberglass Stand

- Level 3 helm package – automotive style vinyl wrapped dash with woodgrain panels, lighted stainless toggle switches, quick release windshield, smoked glass side door, 25 qt. cooler, removable stand access panel and glove box
- Full gauge panel featuring black sterling tachometer, voltmeter and fuel gauge
- Surface storage trays for cell phone and other personal items
- Woodgrain tilt steering wheel with brilliant aluminum non-directional spokes

Electronics

- Jensen high power MSR3007 CD stereo with MP3 plug
- Four Jensen high power speakers with platinum speaker covers
- 12 volt power point

Lighting

- Docking lights built into front walls in heavy duty reinforced housing
- Stainless courtesy light on side of helmstand
- USCG navigation and stern lighting

Furnishings

- Admiral's reclining driver's chair with slide, swivel and self leveling arms
- Two bow commander reclining chairs with slide, swivel and self leveling arms
- Pleated plush designer furnishings
- Round bow table with locking base at front chairs
- Furnishings are created using exclusive Matrix 50 marine upholstery
- Upholstered aluminum seat frames with dry floor matting and flow through ventilation
- Plush deluxe lounge arms
- Portable cup holders

Styling

- Front radius fishing height wall railings
- Rear entry gate with swim platform rear entry ladder
- External wall skins with 29" high 1 1/4" diameter .090" anodized railings
- Hidden wall seams
- Non-skid strips for doorways
- Plush 28 oz. Escalade Hi-Lo carpet
- Deluxe graphics package
- Three dimensional raised logos

Convenience

- Privacy station
- Fire extinguisher
- Four stainless cleat and lifting eye assembly
- 24 gallon fuel capacity
- Thermoform curved table with locking floor base

Canvas and Top

- 10' Bimini top with logo boot
- Transport position support brackets
- Brushed OneTouch™ quick release top locks
- Color matched full mooring cover with vented pole supports

Construction

- 8 1/2" wide
- Two – 25" diameter pontoons
- Double full riser connections
- Heavy duty 3" reinforced deck rail with rubber bumper
- Heavy duty C-channel crossbeams
- 16" OC crossbeam spacing
- Corner castings all four corners
- Extra heavy duty motor pod double bolted with 3/8" SST bolts attached to seven crossbeams
- Gate latches with stainless steel insert and welded safety tab

OPTIONS

Wall and Furniture Color Options

- See page 47

Deck Options

- Aluminum decking

Flooring Options

- Simulated teak flooring – See page 46
- Vinyl flooring (n/a on aluminum deck)
- Snap-in carpet (upgrade to vinyl flooring also required)
- Plush 28 oz. Islands carpet

Captain's Chair Options

- See pages 44 and 45

Furniture Options

- Table options – see pages 44, 45 and 46
- Luxury umbrella for table (Tan only)

Entertaining Options

- Refreshment center COMMANDER in place of lounge arm with sink, electric faucet, two gallon water reservoir, trash can liner and stainless drawer with ice cube cooler

- Convenience center with Corian style surface, paper towel holder and storage (Elite interior only)
- Refrigerator – DC electric stainless steel with slide out top loading cooling compartment in special housing with Corian style surface
- Stainless gas grill

Dash/Electronics Options

- Fishfinder – GPS options – see page 44
- Premium sound system upgrade (six coaxial speakers, subwoofer, amp.)
- Jensen MSR2107 high power waterproof stereo with 1 GB storage and memory stick input (exchange)
- Additional Jensen speakers
- Marine Audio speakers upgrade
- Stainless logo speaker covers (requires M.A. speaker)
- Reserve battery system with Start Now protection

- Battery dual selector switch
- Exclusive fiberglass easy access dual battery box (24' Elite only)

Lighting Options

- Rear underwater lights
- Stainless amber floor mood lighting
- Engine compartment light

Steering Options

- Baystar hydraulic easy-to-turn tilt steering
- Sea Star hydraulic steering for motors over 150 hp
- Electric power assist steering (requires Sea Star upgrade)

Top Options

- Second Bimini top

Performance Options

- Waveglider™ high performance pontoons – see pages 16 and 17
- Sport Graphics Package – see page 19
- Aluminum Waveshield

Watersports Options

- Ski tow bar
- Waterski/wakeboard tower

Camper Enclosure Options – Factory Pre-installed Only

- See page 44

Misc. Options

- 4" raised platform for helmstand and drivers chair
- Exclusive side protector keels
- Livewell under port bow bench
- Wash down kit with sprayer and pump
- Seat covers in place of, or in addition to, mooring cover
- Docklines retractable built in
- Trash can built into lounge arm
- Wine rack built in to lounge arm

INTERIOR OPTIONS

VISTA RC CRUISE

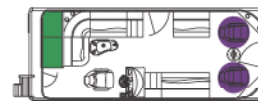

22'

VISTA RC ELITE

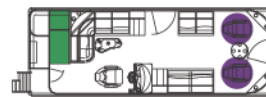

24'

SPECIFICATIONS

LENGTH	22'	24'
Pontoon Diameter	25"	25"
Width	8 1/2'	8 1/2'
Dry Weight	2,050	2,250
Max. Weight Cap.	2,260	2,600
Max. Engine HP	125	150
Max. # People	11	13
Max. People Lbs.	1,600	1,850



Vista RC 22' Cruise

Some models shown with optional equipment.

Tahoe PONTON BOATS

VISTA RC

A PATIO WITH A GREAT VIEW!

VISTA RC has luxury and comfort with the versatility of front reclining chairs and table. This front patio area provides a comfortable space to relax and enjoy the natural beauty that surrounds you while boating.

C
SERIES



Vista RC 24' Elite

2012
Tahoe
PONTON BOATS



STANDARD FEATURES

Helmsman Fiberglass Stand

- Level 3 helm package – Automotive style vinyl wrapped dash with woodgrain panels, lighted stainless toggle switches, quick release windshield, smoked glass side door, 25 qt. cooler, removable stand access panel, and glove box
- Full gauge panel featuring black sterling tachometer, voltmeter, and fuel gauge
- Surface storage trays for cell phone and other personal items
- Woodgrain tilt steering wheel with brilliant aluminum non-directional spokes
- Seastar hydraulic easy to turn tilt steering

Electronics

- Jensen high power MSR3007 CD stereo with MP3 plug
- 4 Jensen high power speakers with platinum speaker covers
- 12 volt power point

Lighting

- Docking lights built into front walls in heavy duty reinforced housing
- Stainless courtesy light on side of helmstand
- USCG navigation and stern lighting

Performance

- Waveglider™ system – high performance pontoons Includes 25" triple pontoons and Tahoe's exclusive Waveglider™ – high performance lifting strakes and 42 gallon fuel tank for center pontoon

Furnishings

- Furnishings are created using exclusive Matrix 50 marine upholstery
- Upholstered aluminum seat frames with dry floor matting and flow through ventilation
- Pleated plush radius designer furnishings
- Plush deluxe lounge arms
- Commander reclining drivers chair with self leveling arms

- Portable cup holders
- Port side bench

Entertainment Areas

- Carpeted rear swim platform area
- One port and one starboard rear swim platform ladder
- Plush dual rear reclining lounges with electric adjustable backs and plush pillows
- Rear Stainless steel railings (or optional rear walls with gates)

Styling

- External wall skins with 29" high 1 1/4" diameter .090" anodized railings
- Hidden wall seams
- Non-skid strips for doorways

- Plush 28 oz. Escalade Hi-Lo carpet
- Deluxe graphics package
- Three dimensional raised logos

Convenience

- Fire extinguisher
- Four stainless cleat and lifting eye assembly
- Thermoform curved table with locking floor base
- Privacy station under rear lounge

Construction

- 8 1/2" wide
- 3 -25" diameter pontoon
- Double full riser connections
- Reinforced deck rail with rubber bumper
- Heavy duty 3" reinforced deck rail with rubber bumper

- Heavy duty C-channel crossbeams
- 16" OC crossbeam spacing
- Corner castings all four corners
- Extra heavy duty motor pod double bolted with 3/8" SST bolts attached to seven crossbeams
- Gate latches with stainless steel insert and welded safety tab

Canvas and Top

- 10' bimini top with logo boot
- Transport position support brackets
- Brushed OneTouch™ quick release top locks
- Color matched full mooring cover with vented pole

OPTIONS

Wall and Furniture Color Options

- See page 47

Deck Options

- Aluminum decking

Flooring Options

- Simulated teak flooring – See page 46
- Vinyl flooring (n/a on aluminum deck)
- Snap-in carpet (upgrade to vinyl flooring also required)
- Plush 28 oz. Islands carpet

Captain's Chair Options

- See pages 44 and 45

Furniture Options

- Table options – see pages 44, 45 and 46
- Luxury umbrella for table (Tan only)

Entertaining Options

- Refreshment center COMMANDER in place of lounge arm with sink, electric faucet, two gallon water reservoir, trash can liner and stainless drawer with ice cube cooler
- Refrigerator – DC electric stainless steel with slide out top loading cooling compartment in special housing with Corian style surface
- Stainless gas grill

Dash/Electronics Options

- Fishfinder – GPS options – see page 44
- Premium sound system upgrade (six coaxial speakers, subwoofer, amp.)
- Jensen MSR2107 high power waterproof stereo with 1 GB storage and memory stick input (exchange)
- Additional Jensen speakers

Marine Audio speakers upgrade

- Stainless logo speaker covers (requires M.A. speaker)
- Reserve battery system with Start Now protection
- Battery dual selector switch

Lighting Options

- Rear underwater lights
- Stainless amber floor mood lighting
- Engine compartment light

Steering Options

- Electric power assist steering

Top Options

- Second Bimini top

Performance Options

- 27" center pontoon
- Sport Graphics Package – see page 19
- Aluminum Waveshield

Watersports Options

- Ski tow bar
- Waterski/wakeboard tower

Camper Enclosure Options – Factory Pre-installed Only

- See page 44

Misc. Options

- Rear walls with gates in place of stainless rails
- 4" raised platform for helmstand and drivers chair
- Exclusive side protector keels
- Livewell under port bow bench
- Wash down kit with sprayer and pump
- Seat covers in place of, or in addition to, mooring cover
- Docklines retractable built in
- Trash can built into lounge arm
- Wine rack built in to lounge arm

INTERIOR OPTIONS

VISTA RL

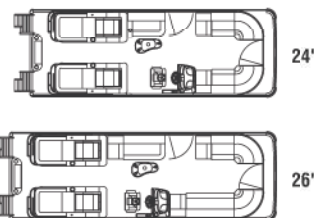

SPECIFICATIONS

LENGTH	24	26
Pontoon Diameter	25"x3	25"x3
Width	8 1/2'	8 1/2'
Dry Weight	3,000	3,125
Max Weight Cap.	2,850	3,200
Max Engine HP	250	300
Max # People	15	17
Max People Lbs.	2,080	2,400



Vista RL 26'



Vista RL 24'

Some models shown with optional equipment.



Tahoe PONTON BOATS

VISTA RL

A LUXURIOUS REAR LOUNGE MODEL WITH
PLUSH POWER ADJUSTABLE SEAT BACKS!

Glide over waves and comfortably sunbathe in the most fully equipped rear lounge model in its class. This triple pontoon Waveglider™ high performance equipped craft features two oversize rear lounges that are extra long and wide enough for two!

Vista RL 24'

2012
Tahoe
PONTON BOATS

C
SERIES



STANDARD FEATURES

Helmman Fiberglass Stand

- Level 3 helm package – automotive style vinyl wrapped dash with woodgrain panels, lighted stainless toggle switches, quick release windshield, smoked glass side door, 25 qt. cooler, removable stand access panel and glove box
- Full gauge panel featuring black sterling tachometer, voltmeter and fuel gauge
- Surface storage trays for cell phone and other personal items
- Woodgrain tilt steering wheel with brilliant aluminum non-directional spokes
- Sea Star hydraulic easy-to-turn tilt steering

Electronics

- Jensen high power MSR3007 CD stereo with MP3 plug
- Six Jensen high power speakers with platinum speaker covers
- 12 volt power point

Lighting

- Docking lights built into front walls in heavy duty reinforced housing
- Stainless courtesy light on side of helmstand
- USCG navigation and stern lighting

Performance

- Waveglider™ system – high performance pontoons – includes 25" triple pontoons and Tahoe's exclusive Waveglider™ – high performance lifting strakes and 42 gallon fuel tank for center pontoon
- Ski tow bar

Furnishings

- Furnishings are created using exclusive Matrix 50 marine upholstery
- Upholstered aluminum seat frames with dry floor matting and flow through ventilation
- Pleated plush radius designer furnishings
- Plush deluxe lounge arms

- Commander's reclining driver's chair with slide, swivel and self leveling arms
- Portable cup holders

Funship Special Equipment

- Deluxe 10' walk-on sun roof with rear ladder, Waterpark™ slide with waterfall water pump, decorative walls, king size upper deck lounge with backs and cushions, upper deck entertainment center with remote, stereo controls, two speakers and storage

Styling

- Front radius wall railings
- Rear entry gate with swim platform rear entry ladder
- External wall skins with 29" high 1 1/4" diameter .090" anodized railings
- Hidden wall seams
- Non-skid strips for doorways
- Plush 28 oz. Escalade Hi-Lo carpet
- Deluxe graphics package
- Three dimensional raised logos

Convenience

- Fire extinguisher
- Four stainless cleat and lifting eye assembly
- Thermoform curved table with locking floor base
- Privacy station

Canvas and Top

- Color matched full mooring cover with vented pole supports

Construction

- 8 1/2" wide
- 25" diameter pontoons
- Double full riser connections
- Heavy duty 3" reinforced deck rail with rubber bumper
- Heavy duty C-channel crossbeams
- 16" OC crossbeam spacing
- Corner castings all four corners
- Extra heavy duty motor pod double bolted with 3/8" SST bolts attached to seven crossbeams
- Gate latches with stainless steel insert and welded safety tab

INTERIOR OPTIONS

VISTA FUNSHIP

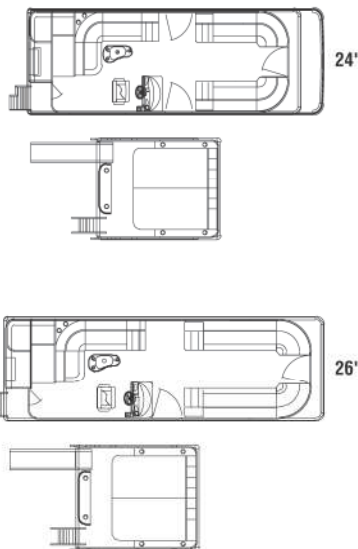

OPTIONS

Wall and Furniture Color Options

- See page 47

Deck Options

- Aluminum decking

Flooring Options

- Simulated teak flooring – See page 46
- Vinyl flooring (n/a on aluminum deck)
- Snap-in carpet (upgrade to vinyl flooring also required)
- Plush 28 oz. Islands carpet

Captain's Chair Options

- See pages 44 and 45

Furniture Options

- Table options – see pages 44, 45 and 46
- Luxury umbrella for table (Tan only)

Entertaining Options

- Convenience center with Corian style surface, paper towel holder and storage
- Refreshment center COMMANDER in place of lounge arm with sink, electric faucet, two gallon water reservoir, trash can liner and stainless drawer with ice cube cooler
- Refrigerator – DC electric stainless steel with slide out top loading cooling compartment in special housing with Corian style surface
- Stainless gas grill

Dash/Electronics Options

- Fishfinder – GPS options – see page 44
- Premium sound system upgrade (six coaxial speakers, subwoofer, amp.)

- Jensen MSR2107 high power waterproof stereo with 1 GB storage and memory stick input (exchange)
- Additional Jensen speakers
- Marine Audio speakers upgrade
- Stainless logo speaker covers (requires M.A. speaker)
- Reserve battery system with Start Now protection
- Exclusive fiberglass easy access dual battery box
- Battery dual selector switch

Lighting Options

- Rear underwater lights
- Stainless amber floor mood lighting
- Engine compartment light

Steering Options

- Electric power assist steering

Top Options

- Bimini top for upper roof
- Front Bimini top

Performance Options

- Sport Graphics Package – see page 19
- Aluminum Waveshield

Camper Enclosure Options – Factory Pre-installed Only

- See page 44

Misc. Options

- 4" raised platform for helmstand and drivers chair
- Exclusive side protector keels
- Rear gates
- Livewell under port bow bench
- Wash down kit with sprayer and pump

SPECIFICATIONS

LENGTH	24'	26'
Pontoon Diameter	25" x 3	25" x 3
Width	8 1/2'	8 1/2'
Dry Weight	3,750	3,850
Max. Weight Cap.	2,665	2,990
Max. Engine HP	225	250
Max. # People	14	16
Max. People Lbs.	1,910	2,190

- Seat covers in place of, or in addition to, mooring cover
- Docklines retractable built in
- Trash can built into lounge arm
- Wine rack built in to lounge arm



Vista Funship 26' Elite



Tahoe PONTON BOATS

VISTA FUNSHIP

NOW EVERYONE CAN ENJOY A DAY OF SLIDING, SKIING, SUNBATHING AND CRUISING WITH THE MOST AFFORDABLE WATER PARK MODEL ANYWHERE!

C
SERIES

Enjoy all the **VISTA FUNSHIP** features, including the slide, king-size sunbathing area and Tahoe's Waveglider™ system for a complete do-everything Funship!



Some models shown with optional equipment.

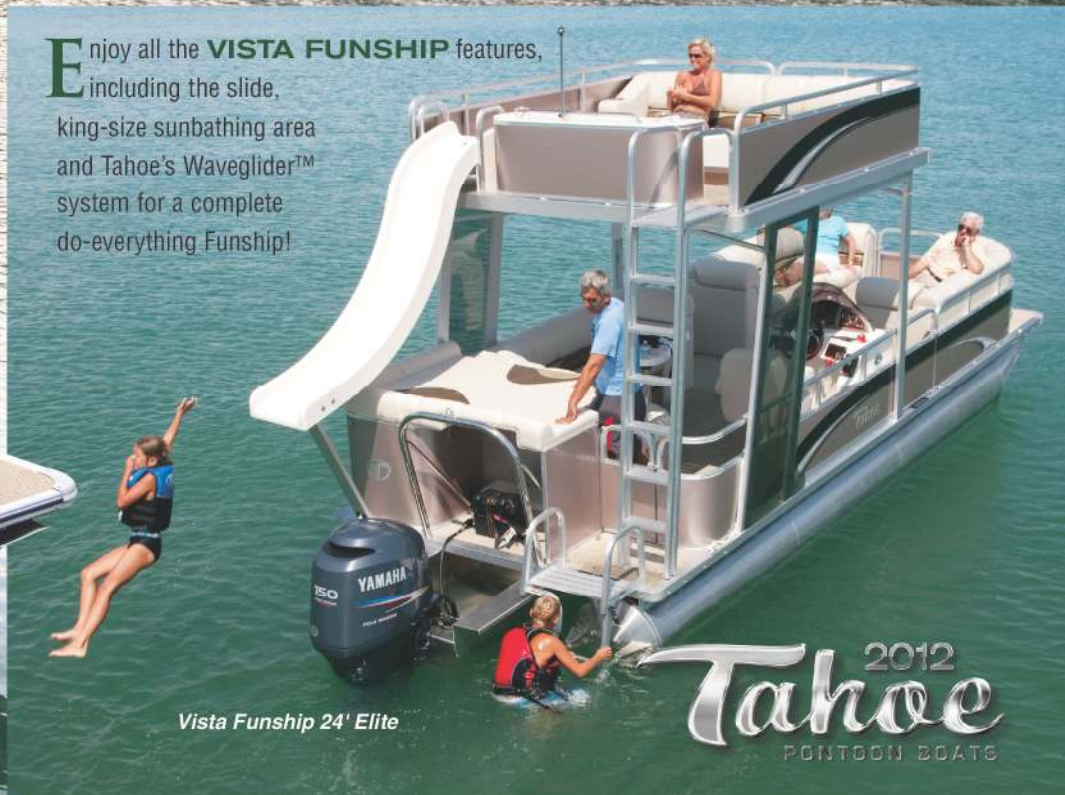

Vista Funship 24' Elite

2012
Tahoe
PONTON BOATS



STANDARD FEATURES

Helmsman Fiberglass Stand

- Level 3 helm package – automotive style vinyl wrapped dash with woodgrain panels, lighted stainless toggle switches, quick release windshield, smoked glass side door, 25 qt. cooler, removable stand access panel and glove box
- Full gauge panel featuring black sterling tachometer, voltmeter and fuel gauge
- Surface storage trays for cell phone and other personal items
- Woodgrain tilt steering wheel with brilliant aluminum non-directional spokes
- Sea Star hydraulic easy-to-turn tilt steering

Electronics

- Jensen high power MSR3007 CD stereo with MP3 plug
- Six Jensen high power speakers with platinum speaker covers
- 12 volt power point

Lighting

- Docking lights built into front walls in heavy duty reinforced housing
- Stainless courtesy light on side of helmstand
- USCG navigation and stern lighting

Performance

- Waveglider™ system – high performance pontoons – includes 25" triple pontoons and Tahoe's exclusive Waveglider™ – high performance lifting strakes and 42 gallon fuel tank for center pontoon
- Ski tow bar

Furnishings

- Furnishings are created using exclusive Matrix 50 marine upholstery
- Upholstered aluminum seat frames with dry floor matting and flow through ventilation
- Pleated plush radius designer furnishings
- Plush deluxe lounge arms

- Admiral's reclining driver's chair with slide, swivel and self leveling arms
- Portable cup holders
- Port side bench

Entertainment Areas

- Commander refreshment center with arm with sink, electric faucet, two gallon water reservoir, trash can liner and stainless drawer with ice cube cooler
- Large rear swim platform area
- One port and one starboard rear swim platform ladder
- Rear bar and music center includes cup holders, remote stereo controls, 12 volt outlet, storage and cube cooler
- Two rear Admiral recliner chairs
- Round table with locking base at rear chairs

Styling

- External wall skins with 29" high 1 1/4" diameter .090" anodized railings
- Hidden wall seams
- Non-skid strips for doorways
- Plush 28 oz. Escalade Hi-Lo carpet
- Deluxe graphics package
- Three dimensional raised logos

Convenience

- Fire extinguisher
- Four stainless cleat and lifting eye assembly
- Privacy station

Canvas and Top

- 10' Bimini top with logo boot
- Transport position support brackets
- Brushed OneTouch™ quick release top locks
- Color matched full mooring cover with vented pole supports

Construction

- 8 1/2" wide
- Double full riser connections
- Heavy duty 3" reinforced deck rail with rubber bumper
- Heavy duty C-channel crossbeams
- 16" OC crossbeam spacing

- Corner castings all four corners

- Extra heavy duty motor pod double bolted with 3/8" SST bolts attached to seven crossbeams
- Gate latches with stainless steel insert and welded safety tab

INTERIOR OPTIONS

VISTA SANDBAR

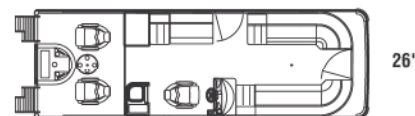

26'

OPTIONS

Wall and Furniture Color Options

- See page 47

Deck Options

- Aluminum decking

Flooring Options

- Simulated teak flooring – See page 46
- Vinyl flooring (n/a on aluminum deck)
- Snap-in carpet (upgrade to vinyl flooring also required)
- Plush 28 oz. Islands carpet

Captain's Chair Options

- See pages 44 and 45

Furniture Options

- Table options – see pages 44, 45 and 46
- Luxury umbrella for table (Tan only)

Entertaining Options

- Refrigerator – DC electric stainless steel with slide out top loading cooling compartment in special housing with Corian style surface
- Stainless gas grill

Dash/Electronics Options

- Fishfinder – GPS options – see page 44
- Premium sound system upgrade (six coaxial speakers, subwoofer, amp.)
- Jensen MSR2107 high power waterproof stereo with 1 GB storage and memory stick input (exchange)
- Additional Jensen speakers
- Marine Audio speakers upgrade

Stainless logo

- speaker covers (requires M.A. speaker)
- Reserve battery system with Start Now protection
- Battery dual selector switch

Lighting Options

- Rear underwater lights
- Stainless amber floor mood lighting

Steering Options

- Electric power assist steering

Top Options

- Second Bimini top

Performance Options

- 27" center pontoon
- Sport Graphics Package – see page 19
- Aluminum Waveshield

Watersports Options

- Waterski/wakeboard tower

Camper Enclosure Options – Factory Pre-installed Only

- See page 44

Misc. Options

- 4" raised platform for helmstand and drivers chair
- Exclusive side protector keels
- Livewell under port bow bench
- Wash down kit with sprayer and pump
- Seat covers in place of, or in addition to, mooring cover
- Docklines retractable built in
- Trash can built into lounge arm
- Wine rack built in to lounge arm

SPECIFICATIONS

LENGTH	26'
Pontoon Diameter	25' x 3
Width	8 1/2'
Dry Weight	3,125
Max. Weight Cap.	3,200
Max. Engine HP	300
Max. # People	15
Max. People Lbs.	2,400

Vista Sandbar 26'

Some models shown with optional equipment.



Tahoe PONTON BOATS

VISTA SANDBAR

GET READY TO PARTY!

C
SERIES

Park at your favorite cove and watch how a great stereo, the standard rear entertainment bar and the easy access rear deck with plenty of dancing room will have everyone coming to your **SANDBAR** to party the day away!



Vista Sandbar 26'

2012
Tahoe
PONTON BOATS



STANDARD FEATURES

Helmman Fiberglass Stand

- Level 3 helm package – automotive style vinyl wrapped dash with woodgrain panels, lighted stainless toggle switches, quick release windshield, smoked glass side door, 25 qt. cooler, removable stand access panel and glove box
- Full gauge panel featuring black sterling tachometer, voltmeter and fuel gauge
- Surface storage trays for cell phone and other personal items
- Woodgrain tilt steering wheel with brilliant aluminum non-directional spokes

Electronics

- Jensen high power MSR3007 CD stereo with MP3 plug
- Four Jensen high power speakers with platinum speaker covers
- 12 volt power port

Lighting

- Docking lights built into front walls in heavy duty reinforced housing
- Stainless courtesy light on side of helmstand
- USCG navigation and stern lighting

Furnishings

- Commander's reclining driver's chair with slide, swivel and self leveling arms
- Furnishings are created using exclusive Matrix 50 marine upholstery
- Upholstered aluminum seat frames with dry floor matting and flow through ventilation
- Plush deluxe lounge arms
- Portable cup holders

Styling

- Large bow deck area
- 2' rear deck area with two swim platform ladders
- External wall skins with 29" high 1 1/4" diameter .090" anodized railings
- Hidden wall seams

- Non-skid strips for doorways
- Plush 28 oz. Escalade Hi-Lo carpet
- Deluxe graphics package
- Three dimensional raised logos

Convenience

- Privacy station with latched door
- Fire extinguisher
- Four stainless cleat and lifting eye assembly
- 24 gallon fuel capacity
- Thermoform curved table with locking floor base

Canvas and Top

- 10' Bimini top with logo boot
- Transport position support brackets
- Brushed OneTouch™ quick release top locks

- Color matched full mooring cover with vented pole supports

Construction

- 8 1/2" wide
- Two – 25" diameter pontoons
- Double full riser connections
- Heavy duty 3" reinforced deck rail with rubber bumper
- Heavy duty C-channel crossbeams
- 16" OC crossbeam spacing
- Corner castings all four corners
- Extra heavy duty motor pod double bolted with 3/8" SST bolts attached to seven crossbeams
- Gate latches with stainless steel insert and welded safety tab

INTERIOR OPTIONS

BLUE RIDGE RD

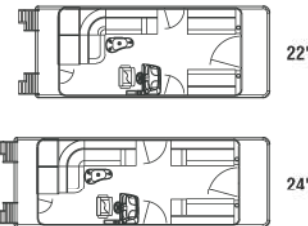

SPECIFICATIONS

LENGTH	22'	24'
Pontoon Diameter	25"	25"
Width	8 1/2'	8 1/2'
Dry Weight	2,050	2,250
Max. Weight Cap.	2,260	2,600
Max. Engine HP	125	150
Max. # People	11	13
Max. People Lbs.	1,600	1,850

OPTIONS

Wall and Furniture Color Options

- See page 47

Deck Options

- Aluminum decking

Flooring Options

- Simulated teak flooring – See page 46
- Vinyl flooring (n/a on aluminum deck)
- Snap-in carpet (upgrade to vinyl flooring also required)
- Plush 28 oz. Islands carpet

Captain's Chair Options

- See pages 44 and 45

Furniture Options

- Table options – see pages 44, 45 and 46
- Luxury umbrella for table (Tan only)

Entertaining Options

- Refreshment center COMMANDER in place of lounge arm with sink, electric faucet, two gallon water reservoir, trash can liner and stainless drawer with ice cube cooler
- Refrigerator – DC electric stainless steel with slide out top loading cooling compartment in special housing with Corian style surface
- Stainless gas grill

Dash/Electronics Options

- Fishfinder – GPS options – see page 44
- Premium sound system upgrade (six coaxial speakers, subwoofer, amp.)
- Jensen MSR2107 high power waterproof stereo with 1 GB storage and memory stick input (exchange)
- Additional Jensen speakers
- Marine Audio speakers upgrade
- Stainless logo speaker covers (requires M.A. speaker)

- Reserve battery system with Start Now protection
- Battery dual selector switch

Lighting Options

- Stainless amber floor mood lighting
- Rear underwater lights

Steering Options

- Baystar hydraulic easy-to-turn tilt steering
- Sea Star hydraulic steering for motors over 150 hp
- Electric power assist steering (requires Sea Star upgrade)

Top Options

- Second Bimini top

Performance Options

- Waveglider™ high performance pontoons – see pages 16 and 17
- Aluminum Waveshield

Watersports Options

- RD ski tow bar
- Waterski/wakeboard tower

Camper Enclosure Options – Factory Pre-installed Only

- See page 44

Misc. Options

- 4" raised platform for helmstand and drivers chair
- Exclusive side protector keels
- Livewell under port bow bench
- Wash down kit with sprayer and pump
- Seat covers in place of, or in addition to, mooring cover
- Docklines retractable built in
- Trash can built into lounge arm
- Wine rack built in to lounge arm



Blue Ridge 22' RD

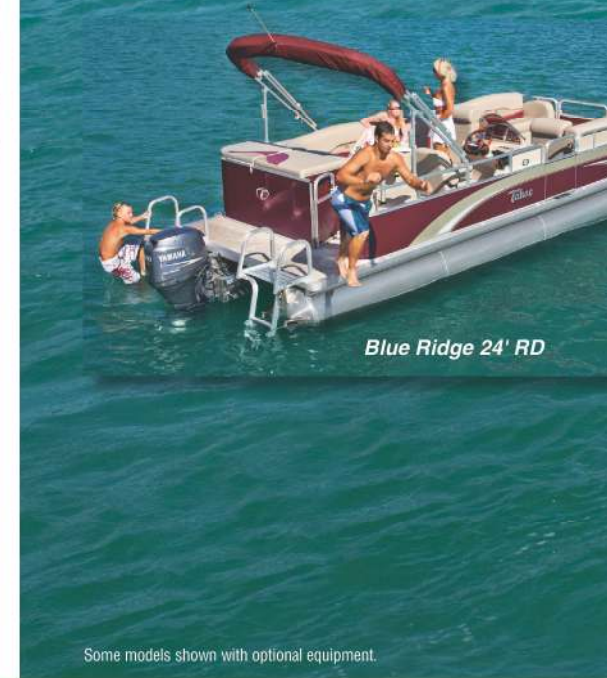

Blue Ridge 24' RD

Some models shown with optional equipment.

Tahoe PONTON BOATS

BLUE RIDGE

AN ISLAND FOR SWIMMING

C
SERIES

BLUE RIDGE features two large recreation areas front and rear for diving, tanning or fishing. The rear deck is great for storing inflatable water toys, too!



Blue Ridge 24' RD

2012
Tahoe
PONTON BOATS



STANDARD FEATURES

Helmman Fiberglass Stand

- Level 3 helm package – carbon fiber dash with platinum panels, lighted stainless toggle switches, quick release windshield, smoked glass side door, 25 qt. cooler, removable stand access panel and glove box
- Full gauge panel featuring black sterling tachometer, voltmeter and fuel gauge
- Surface storage trays for cell phone and other personal items
- Carbon fiber tilt steering wheel with brilliant aluminum non-directional spokes

Electronics

- Garmin 500C color Fishfinder
- Jensen high power MSR3007 CD stereo with MP3 plug
- Four Jensen high power speakers with platinum speaker covers
- 12 volt power point

Lighting

- Docking lights built into front walls in heavy duty reinforced housing
- Stainless courtesy light on side of helmstand
- USCG navigation and stern lighting

Furnishings

- Furnishings are created using exclusive Matrix 50 marine upholstery
- Upholstered aluminum seat frames with dry floor matting and flow through ventilation
- Plush designer furnishings
- Plush deluxe lounge arms (excluded in some interiors)
- Commander's reclining driver's chair with slide, swivel and self leveling arms
- Portable cup holders

Fishing Features

- Two front fishing stations with rod holder (FNF, FNC)
- Two rear fishing stations with rod holder
- Rear rod box
- Tackle trays
- Large livewell over fuel tank

- Small livewell under bow bench (FNF, FNC)

Styling

- Front fishing height walls (FNF, FNC)
- Rear fishing height walls (FNF, FNC, RF)
- Rear entry gate with swim platform ladder
- Two bow benches (RF, FNC)
- External wall skins with 29" high 1 1/4" diameter .090" anodized railings
- Hidden wall seams
- Non-skid strips for doorways
- Plush 28 oz. Escalade Hi-Lo carpet
- Deluxe graphics package
- Three dimensional raised logos

Convenience

- Fire extinguisher
- Four stainless cleat and lifting eye assembly
- 24 gallon fuel capacity
- Thermoform curved table with locking floor base
- Privacy station with latched door

Canvas and Top

- 10' Bimini top with logo boot
- Transport position support brackets
- Brushed OneTouch™ quick release top locks
- Color matched full mooring cover with vented pole supports

Construction

- 8 1/2" wide
- Two - 25" diameter pontoons
- Double full riser connections
- Heavy duty 3" reinforced deck rail with rubber bumper
- Heavy duty C-channel crossbeams
- 16" OC crossbeam spacing
- Corner castings all four corners
- Extra heavy duty motor pod double bolted with 3/8" SST bolts attached to seven crossbeams
- Gate latches with stainless steel insert and welded safety tab

SPECIFICATIONS

LENGTH	18'	20'	22'	24'
Pontoon Diameter	25"	25"	25"	25"
Width	8 1/2'	8 1/2'	8 1/2'	8 1/2'
Dry Weight	1,650	1,800	2,050	2,250
Max. Weight Cap.	1,870	2,130	2,260	2,600
Max. Engine HP	90	115	125	150
Max. # People	9	10	11	13
Max People Lbs.	1,270	1,380	1,600	1,850

INTERIOR OPTIONS

C-FISH FISH N' CRUISE RE

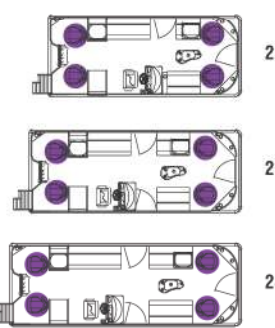

C-FISH FISH N' FUN RE

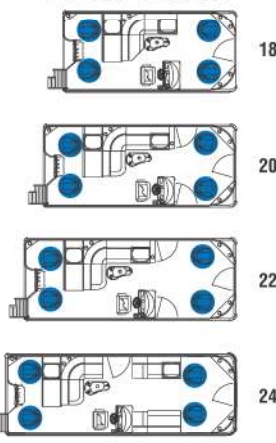

C-FISH REAR FISH RE

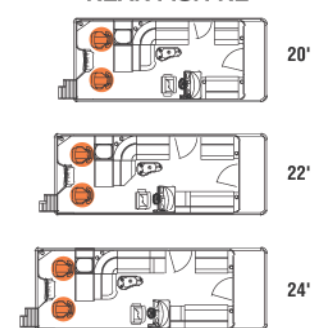

OPTIONS

Wall and Furniture Color Options

- See page 47

Deck Options

- Aluminum decking

Flooring Options

- Simulated teak flooring – See page 46
- Vinyl flooring (n/a on aluminum deck)
- Snap-in carpet (upgrade to vinyl flooring also required)
- Plush 28 oz. Islands carpet

Captain's Chair Options

- See pages 44 and 45

Furniture Options

- Table options – see pages 44, 45 and 46
- Luxury umbrella for table (Tan only)

Entertaining Options

- Stainless gas grill

Dash/Electronics Options

- GPS options – see page 44
- Premium sound system upgrade (six coaxial speakers, subwoofer, amp.)
- Jensen MSR2107 high power waterproof stereo with 1 GB storage and memory stick input (exchange)
- Additional Jensen speakers
- Marine Audio speakers upgrade
- Stainless logo speaker covers (requires M.A. speaker)
- Reserve battery system with Start Now protection
- Battery dual selector switch

Lighting Options

- Rear underwater lights
- Stainless amber floor mood lighting

Steering Options

- Baystar hydraulic easy-to-turn tilt steering
- Sea Star hydraulic steering for motors over 150 hp
- Electric power assist steering (requires Sea Star upgrade)

Top Options

- Second Bimini top

Performance Options

- Waveglider™ high performance pontoons – see pages 16 and 17
- Sport Graphics Package – see page 19
- Aluminum Waveshield

Watersports Options

- Ski tow bar
- Waterski/wakeboard tower

Camper Enclosure Options – Factory Pre-installed Only

- See page 44

Misc. Options

- 4" raised platform for helmstand and drivers chair
- Exclusive side protector keels
- Wash down kit with sprayer and pump
- Seat covers in place of, or in addition to, mooring cover
- Docklines retractable built in
- Trash can built into lounge arm
- Wine rack built in to lounge arm
- 1/2 front gate with trolling motor plug (factory installed only)



C-Fish 24' FF



Tahoe PONTON BOATS

C-FISH

MORE PEOPLE THAT FISH
CHOOSE TAHOE C-FISH!

C
SERIES



C-Fish 20' FF



C-Fish 22' RF



C-Fish 22' FNC

Only Tahoe gives you your choice of three fully loaded fishing models featuring livewells, comfortable fishing chairs and a Garmin Fishfinder graph.

Most models include a built in tackle box, rod holders and a rod storage box, too. With all of the different fishing layouts available in the **TAHOE C-FISH**, it should be easy to find the fishing set-up that's just right for your family.

2012
Tahoe
PONTON BOATS

Some models shown with optional equipment.



STANDARD FEATURES

Captain's Deluxe Polished Contoured Stand

- Level 2 helm package – woodgrain dash panel with lighted rocker switches
 - 8' standard or optional 8 1/2' wide
 - Smoked glass side door and removable stand access panel
 - Full gauge panel featuring black sterling tachometer, voltmeter and fuel gauge
 - Surface storage tray for cell phone and other personal items
 - Quick release windshield
 - Woodgrain insert steering wheel
- Electronics**
- Jensen high power MSR3007 CD stereo with MP3 plug
 - Two Jensen high power speakers with platinum speaker covers
 - 12 volt power point

Lighting

- Stainless courtesy light on side of helmstand
- USCG navigation and stern lighting

Furnishings

- Furnishings are created using exclusive Matrix 50 marine upholstery
- Upholstered aluminum seat frames with flow through ventilation
- Plush custom furnishings
- Champagne perf accent vinyl
- Lounge arms with storage
- Captain driver's chair with moveable arms

Styling

- Front radius walls
- Rear entry gate with swim platform rear entry ladder
- External wall skins with 29" high 1 1/4" diameter .090" anodized railings

- Hidden wall seams
- Non-skid strips for doorways
- Plush textured carpet
- Mural graphics package

Convenience

- Large rear storage compartment with door
- Four stainless cleat and lifting eye assembly
- Upholstered aluminum oval table with cup holders
- 12 gallon tank (24 gallon tank when upgraded to 8.5 wide)

Canvas and Top

- 8' Bimini top with boot
- Transport position support brackets
- Brushed OneTouch™ quick release top locks

Construction

- Two – 23" standard or optional 25" diameter pontoons
- Heavy duty 3" reinforced deck rail with rubber bumper
- Heavy duty C-channel crossbeams
- Corner castings all four corners
- Extra heavy duty motor pod double bolted with 3/8" SST bolts attached to seven crossbeams
- Gate latches with stainless steel insert and welded safety tab

SPECIFICATIONS

Length	16'	18'	20'	22'	24'
STANDARD PONTOON DIA.	23"	23"	23"	23"	23"
Standard Width	8'	8'	8'	8'	8'
Dry Weight	1,350	1,600	1,750	2,000	2,200
Max. Weight Cap.	1,380	1,575	1,805	2,000	2,210
Max. Engine HP	50	75	90	100	125
Max. # People	6	8	9	10	11
Max. People Lbs.	950	1,070	1,250	1,450	1,530
OPTIONAL PONTOON DIA.	25"	25"	25"	25"	25"
Optional Width	8 1/2'	8 1/2'	8 1/2'	8 1/2'	8 1/2'
Dry Weight	1,425	1,650	1,800	2,050	2,250
Max. Weight Cap.	1,580	1,870	2,130	2,260	2,600
Max. Engine HP	60	90	115	125	150
Max. # People	7	9	10	11	13
Max. People Lbs.	1,050	1,270	1,380	1,600	1,850

OPTIONS

Base Boat Options

- 8.5' option includes: 24 gallon fuel system, 25" diameter pontoons, 8 1/2' x 10' Bimini top, privacy curtain and frame
- Premium Package – 8.5' option PLUS: color wall skin, chrome DL, Island's carpet, Commander's chair, tilt steering, SST cup holders, kidney table, playpen cover

Wall and Furniture Color Options

- See page 47

Deck Options

- Aluminum decking

Flooring Options

- Simulated teak flooring – See page 46
- Vinyl flooring (n/a on aluminum deck)
- Snap-in carpet (upgrade to vinyl flooring also required)

- Plush 28 oz. Escalade carpet
- Plush 28 oz. Islands carpet

Captain's Chair Options

- See pages 44 and 45

Furniture Options

- Table options – see pages 44, 45 and 46
- Luxury umbrella for table (Tan only)

Dash/Electronics Options

- Fishfinder – GPS options – see page 44
- Premium sound system upgrade (six coaxial speakers, subwoofer, amp.)
- Jensen MSR2107 high power waterproof stereo with 1 GB storage and memory stick input (exchange)
- Additional Jensen speakers
- Marine Audio speakers upgrade

- Stainless logo speaker covers (requires M.A. speaker)

- Battery dual selector switch
- Reserve battery system with Start Now protection

Lighting Options

- Rear underwater lights
- Stainless amber floor mood lighting
- Docking lights built into front walls (includes standard white docklight housings)
- Chrome housings for docklights
- Engine compartment light

Steering Options

- Mechanical tilt steering
- Baystar hydraulic easy-to-turn tilt steering
- Sea Star hydraulic steering for motors over 150 hp

- Electric power assist steering (requires Sea Star upgrade)

Canvas and Top Options

- Second Bimini top
- Color matched playpen cover
- Color matched seat covers

Pontoon Options

- 23" to 25" upgrade
- Exclusive side protector keels

Performance Options

- Waveglider™ high performance pontoons – see pages 16 and 17
- Sport Graphics Package – see page 19
- Aluminum Waveshield

Watersports Options

- Ski tow bar

- Waterski/wakeboard tower – 8.5' wide only

Camper Enclosure Options – Factory Pre-installed Only

- See page 44

Entertaining Options

- Stainless gas grill

Misc. Options

- Livewell under port bow bench
- Wash down kit with sprayer and pump
- Privacy station curtain and frame conversion for storage area
- Docklines retractable built in
- Logo soft cooler
- Portable cup holders

INTERIOR OPTIONS

CASCADE CRUISE

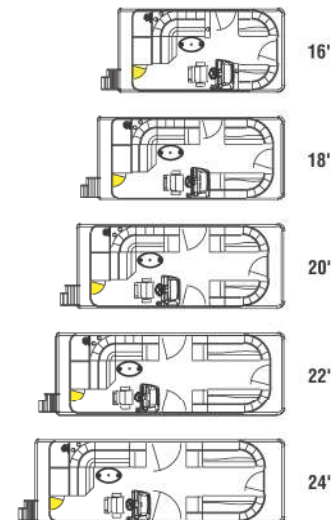

Cascade 20' Cruise



Tahoe PONTOON BOATS

CASCADE

THE POPULAR CHOICE!

A
SERIES



Cascade 24' Cruise



Cascade 16' Cruise



Cascade 22' Cruise



Cascade 18' Cruise

A great way to start boating with high quality and less investment, the **TAHOE CASCADE** won't disappoint. Cascade is built with the same quality that goes into every Tahoe. Solid structure, plush Matrix 50 seating, CD stereo and gauges provide the right amount of features for years of fun on the water.

Some models shown with optional equipment.

2012
Tahoe
PONTON BOATS



STANDARD FEATURES

Captain's Deluxe Polished Contoured Stand

- Level 2 helm package – woodgrain dash panel with lighted rocker switches
- Smoked glass side door and removable stand access panel
- Full gauge panel featuring black sterling tachometer, voltmeter and fuel gauge
- Surface storage tray for cell phone and other personal items
- Quick release windshield
- Sea Star hydraulic easy-to-turn tilt steering
- Woodgrain insert steering wheel

Electronics

- Jensen high power MSR3007 CD stereo with MP3 plug
- Two Jensen high power speakers with platinum speaker covers
- 12 volt power point

Lighting

- Stainless courtesy light on side of helmstand
- USCG navigation and stern lighting

Performance

- Triple 25" pontoons with 42 gallon built in fuel system

Furnishings

- Furnishings are created using exclusive Matrix 50 marine upholstery
- Upholstered aluminum seat frames with flow through ventilation
- Double size plush rear lounge with pillowed head rest, large bed area and rail pillows
- Plush bow benches
- Champagne perf accent vinyl
- Bow bench lounge arm with storage
- Captain driver's chair with moveable arms

Styling

- Front radius walls
- Rear entry gate with swim platform rear entry ladder
- External wall skins with 29" high 1 1/4" diameter .090" anodized railings
- Hidden wall seams
- Non-skid strips for doorways
- Plush textured carpet
- Mural graphics package

Convenience

- Four stainless cleat and lifting eye assembly
- Oval table with cup holders

Canvas and Top

- 8' Bimini top with boot
- Transport position support brackets
- Brushed OneTouch™ quick release top locks

Construction

- 8 1/2" wide
- 25" diameter pontoons

- Heavy duty 3" reinforced deck rail with rubber bumper
- Heavy duty C-channel crossbeams
- Corner castings all four corners

- Extra heavy duty motor pod double bolted with 3/8" SST bolts attached to seven crossbeams
- Gate latches with stainless steel insert and welded safety tab

INTERIOR OPTIONS

CASCADE DRL

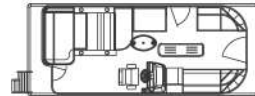

22'

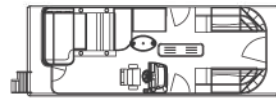

24'

OPTIONS

Wall and Furniture Color Options

- See page 47

Deck Options

- Aluminum decking

Flooring Options

- Simulated teak flooring – See page 46
- Vinyl flooring (n/a on aluminum deck)
- Snap-in carpet (upgrade to vinyl flooring also required)
- Plush 28 oz. Escalade carpet
- Plush 28 oz. Islands carpet

Captain's Chair Options

- See pages 44 and 45

Furniture Options

- Table options – see pages 44, 45 and 46
- Luxury umbrella for table (Tan only)

Dash/Electronics Options

- Fishfinder – GPS options – see page 44

- Premium sound system upgrade (six coaxial speakers, subwoofer, amp.)
- Jensen MSR2107 high power waterproof stereo with 1 GB storage and memory stick input (exchange)
- Additional Jensen speakers
- Marine Audio speakers upgrade
- Stainless logo speaker covers (requires M.A. speaker)
- Battery dual selector switch
- Reserve battery system with Start Now protection

Lighting Options

- Rear underwater lights
- Stainless amber floor mood lighting
- Docking lights built into front walls (includes standard white docklight housings)

- Chrome housings for docklights
- Engine compartment light

Steering Options

- Electric power assist steering

Canvas and Top Options

- Second Bimini top
- Color matched playpen cover
- Color matched seat covers

Performance Options

- Waveglider™ high performance lifting fins for all 3 pontoons
- Sport Graphics Package – see page 19
- Aluminum waveshield

Watersports Options

- Ski tow bar
- Waterski/wakeboard tower

Camper Enclosure Options – Factory Pre-installed Only

- See page 44

Entertaining Options

- Stainless gas grill

Misc. Options

- Exclusive side protector keels

- Livewell under port bow bench
- Wash down kit with sprayer and pump
- Privacy station curtain and frame to fit under rear bed
- Docklines retractable built in
- Portable cup holders

SPECIFICATIONS

LENGTH	22'	24'
Pontoon Diameter	25" x 3	25" x 3
Standard Width	8 1/2'	8 1/2'
Dry Weight	2,800	3,000
Max Weight Cap.	2,650	2,850
Max Engine HP	225	250
Max. # People	12	15
Max. People Lbs.	1,780	2,080

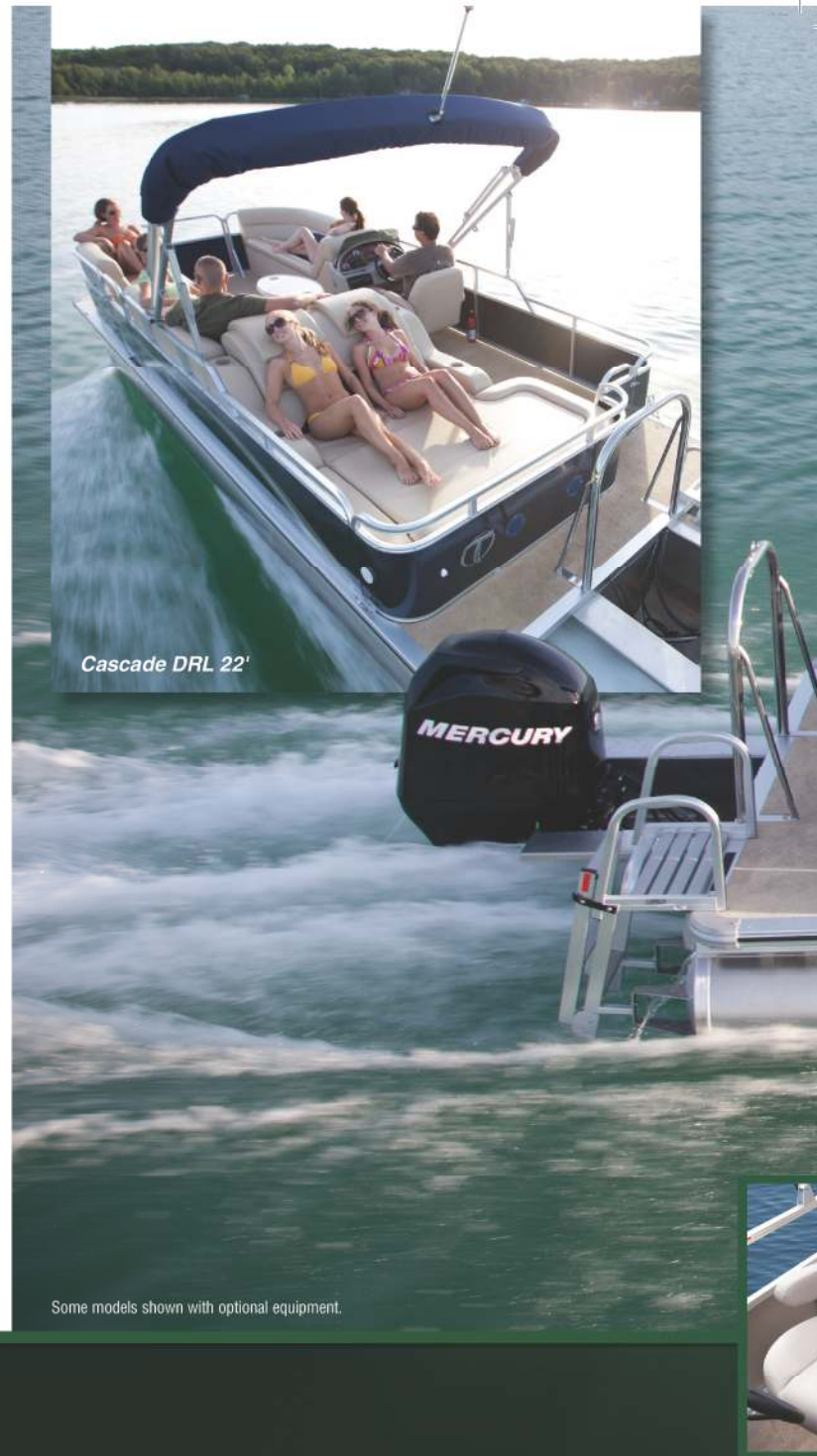

Cascade DRL 22'

Some models shown with optional equipment.

Tahoe PONTON BOATS

CASCADE DRL

A COMFORTABLE SPOT FOR EVERYONE

When you can have the whole family on a craft that has plenty of together room it is the best of times. In addition to lots of traditional seating, **CASCADE DRL** has a huge double wide rear lounge so lots of people can gather and talk, ride, relax and sunbathe.

A
SERIES

Cascade DRL 22'



2012
Tahoe
PONTON BOATS



STANDARD FEATURES

Captain's Deluxe Polished Contoured Stand

- Level 2 helm package – carbon fiber dash panel with lighted rocker switches
- Huron black steering wheel
- Smoked glass side door and removable stand access panel
- Full gauge panel featuring black sterling tachometer, voltmeter and fuel gauge
- Surface storage tray for cell phone and other personal items
- Quick release windshield

Electronics

- Jensen high power MSR3007 CD stereo with MP3 plug
- Two Jensen high power speakers with platinum speaker covers
- Garmin 200 Fishfinder
- 12 volt power point
- Lighting**
- Stainless courtesy light on side of helmstand
- USCG navigation and stern lighting

Furnishings

- Furnishings are created using exclusive Matrix 50 marine upholstery
- Upholstered aluminum seat frames with flow through ventilation
- Hidden wall seams
- Non-skid strips for doorways
- Plush textured carpet
- Mural graphics package
- Convenience**
- Large storage compartment with door (except BF)
- Four stainless cleat and lifting eye assembly

Styling

- Rear entry gate with swim platform rear entry ladder
- External wall skins with 29" high 1 1/4" diameter .090" anodized railings
- Hidden wall seams
- Non-skid strips for doorways
- Plush textured carpet
- Mural graphics package
- Convenience**
- Large storage compartment with door (except BF)
- Four stainless cleat and lifting eye assembly

- Oval table with cup holders
- 12 gallon fuel system
- Canvas and Top**
- 8' Bimini top with boot
- Transport position support brackets
- Brushed OneTouch™ quick release top locks
- Construction**
- 8' wide
- Two – 23" standard or optional 25" diameter pontoons

- Heavy duty 3" reinforced deck rail with rubber bumper
- Heavy duty C-channel crossbeams
- Corner castings all four corners
- Extra heavy duty motor pod double bolted with 3/8" SST bolts attached to seven crossbeams
- Gate latches with stainless steel insert and welded safety tab

Fishing Features

- Two front fishing stations with rod holder (FNF)
- Two rear fishing stations with rod holder (FNF, RF)
- Two fishing chairs on front deck (BF)
- Large livewell over fuel tank (FNF, RF)
- Small livewell under bow bench (BF)
- Front fishing height walls (FNF)
- Rear fishing height walls (FNF, RF)

OPTIONS

Wall and Furniture Color Options

- See page 47

Deck Options

- Aluminum decking

Flooring Options

- Simulated teak flooring – See page 46
- Vinyl flooring (n/a on aluminum deck)
- Snap-in carpet (upgrade to vinyl flooring also required)
- Plush 28 oz. Escalade carpet
- Plush 28 oz. Islands carpet

Captain's Chair Options

- See pages 44 and 45

Furniture Options

- Table options – see pages 44, 45 and 46
- Luxury umbrella for table (Tan only)

Dash/Electronics Options

- Fishfinder – GPS options – see page 44
- Premium sound system upgrade (six coaxial speakers, subwoofer, amp.)
- Jensen MSR2107 high power waterproof stereo with 1 GB storage and memory stick input (exchange)

- Additional Jensen speakers
- Marine Audio speakers upgrade
- Stainless logo speaker covers (requires M.A. speaker)
- Battery dual selector switch
- Reserve battery system with Start Now protection

Lighting Options

- Stainless amber floor mood lighting
- Docking lights built into front walls (includes standard white docklight housings)
- Chrome housings for docklights
- Rear underwater lights

Steering Options

- Mechanical tilt steering
- Baystar hydraulic easy-to-turn tilt steering
- Sea Star hydraulic steering for motors over 150 hp
- Electric power assist steering (requires Sea Star upgrade)

Canvas and Top Options

- Second Bimini top
- Color matched playpen cover
- Color matched seat covers

Pontoon Options

- 23" to 25" upgrade
- Exclusive side protector keels

Performance Options

- Waveglider™ high performance pontoons – see pages 16 and 17
- Sport Graphics Package – see page 19
- Aluminum Waveshield

Watersports Options

- Ski tow bar

Camper Enclosure Options – Factory Pre-installed Only

- See page 44

Entertaining Options

- Stainless gas grill

Misc. Options

- Privacy station curtain and frame conversion for storage area
- Livewell under port bow bench
- Wash down kit with sprayer and pump
- Docklines retractable built in
- Portable cup holders

SPECIFICATIONS

Length	18'	20'	22'	24'
STANDARD PONTOON DIA.	23"	23"	23"	23"
Standard Width	8'	8'	8'	8'
Dry Weight	1,600	1,750	2,000	2,200
Max. Weight Cap.	1,575	1,805	2,000	2,210
Max. Engine HP	75	90	100	125
Max. # People	8	9	10	11
Max. People Lbs.	1,070	1,250	1,450	1,530

INTERIOR OPTIONS

FISH N' FUN RE

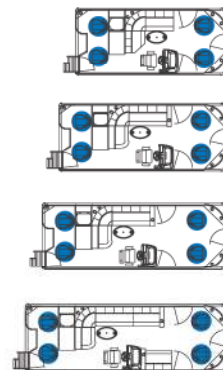

BOW FISH RE

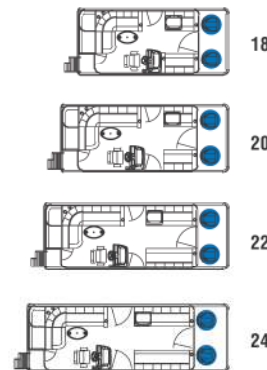

REAR FISH RE

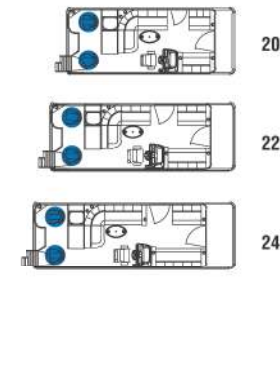

A Fish 20' BF



A Fish 22' RF

Some models shown with optional equipment.

Tahoe PONTOON BOATS

A Fish 22' FNF

A FISH ...BRINGS PONTOON FISHING TO ANY BUDGET

A
SERIES

A Fish 24' FNF

If your type of Fishing doesn't require a lot of complication the **A-FISH** is right for you. A-Fish will provide the livewell, fishfinder and rod holders, you supply the fun!

2012
Tahoe
PONTOON BOATS



STANDARD FEATURES

Captain's Deluxe Polished Contoured Stand

- Level 1 helm package – brushed champagne dash panel lighted rocker switches
- Smoked glass side door and removable stand access panel
- Non-directional Huron steering wheel

Electronics

- 12 volt power point

Lighting

- Stainless courtesy light on side of helmstand
- USCG navigation and stern lighting

Furnishings

- Furnishings are created using exclusive Matrix 50 marine upholstery
- Upholstered aluminum seat frames with flow through ventilation

- Radius plush designer furnishings
- Champagne perf accent vinyl

Family Models

- Two front bow benches (Family models)

Fishing Models

- Two front fishing chairs
- Livewell under port bench

Styling

- Front radius walls
- External wall skins with 26" high 1 1/4" diameter .090" anodized railings
- Hidden wall seams
- Non-skid strips for doorways
- Plush textured carpet
- Mural graphics package

Convenience

- Four stainless cleat and lifting eye assembly

Canvas and Top

- 8' x 7' Bimini top with boot
- Bimini quick release pull pins

Construction

- 7" wide
- 23" pontoons
- Heavy duty 3" reinforced deck rail
- Heavy duty C-channel crossbeams
- Corner castings all four corners
- Extra heavy duty motor pod double bolted with 3/8" SST bolts attached to seven crossbeams
- Gate latches with stainless steel insert and welded safety tab

SPECIFICATIONS

LENGTH	14'	16'
Pontoon Diameter	23"	23"
Width	7'	7'
Dry Weight	1,150	1,350
Max. Weight Cap.	1,170	1,380
Max. Engine HP	40	50
Max. # People	5	6
Max. People Lbs.	800	950

INTERIOR OPTIONS

SPORT FAMILY

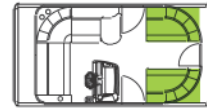

14'

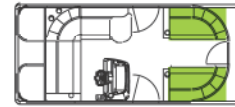

16'

SPORT 16' OPTIONAL FAMILY RE

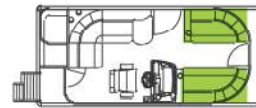

16'

SPORT FISH

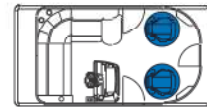

14'

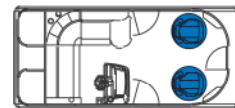

16'

SPORT 16' OPTIONAL FISH RE

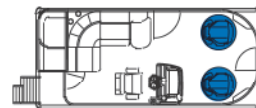

16'

OPTIONS

Wall and Furniture Color Options

- See page 47

Deck Options

- Aluminum decking

Flooring Options

- Vinyl flooring (n/a on aluminum deck)
- Snap-in carpet (upgrade to vinyl flooring also required)
- Plush 28 oz. Escalade carpet
- Plush 28 oz. Islands carpet

Furniture Options

- Table options – see pages 44, 45 and 46
- Rear entry gate with ladder and custom Captain driver's chair with moveable arms (16' only)

Dash/Electronics Options

- Tachometer, voltmeter and fuel gauge
- Jensen high power MSR3007 CD stereo with MP3 plug
- Jensen waterproof CD stereo MSR7007
- Jensen high power speakers with platinum speaker covers
- Additional Jensen speakers
- Marine Audio speakers exch.
- Stainless logo speaker covers (requires M.A. speaker)
- Fishfinder – GPS options – see page 44

- Battery dual selector switch
- Windshield

Lighting Options

- Rear underwater lights
- Stainless amber floor mood lighting
- Docking lights built into front walls (includes standard white docklight housings)
- Chrome housings for docklights

Steering Options

- Mechanical tilt steering

Pontoon Options

- 23" to 25" upgrade

- Exclusive side protector keels

Misc. Options

- Stainless gas grill
- Livewell under port bow bench (Fam)
- Wash down kit with sprayer and pump
- Color matched seat covers
- Color matched playpen cover
- Docklines retractable built in
- Portable cup holders



Sport 14' Fish

Sport 16'

Some models shown with optional equipment.



Tahoe PONTON BOATS

SPORT

AMERICA'S ECONOMICAL
COMPACT PONTOON

A
SERIES



You can take the stylish **TAHOE SPORT** anywhere. The 7' wide body is easy to trailer, requires only small gas horsepower and is perfect for electric outboards. The plush feel and classy radius look will have you looking smart in this economical pontoon boat.

Sport 14'

2012
Tahoe
PUNTOON BOATS



STANDARD FEATURES

Captain's Deluxe Polished Contoured Stand

- Level 2 helm package – Woodgrain dash panel with lighted rocker switches
- Smoked glass side door, removable stand access panel
- Full gauge panel featuring black sterling tachometer, voltmeter
- Surface storage tray for cell phone and other personal items
- Woodgrain insert steering wheel

Electronics

- Jensen high power MSR3007 CD stereo with MP3 plug
- Two Jensen high power speakers with platinum speaker covers
- 12 volt power point

Lighting

- Stainless courtesy light on side of helmstand
- USCG navigation and stern lighting

Furnishings

- Furnishings are created using exclusive Matrix 50 marine upholstery

- Upholstered aluminum seat frames with flow through ventilation
- Plush custom furnishings
- Champagne perf accent vinyl
- Lounge arms
- Captain driver's chair with moveable arms

Styling

- Front radius walls
- Rear entry gate with swim platform rear entry ladder
- 13" rear deck area
- External wall skins with 29" high 1 1/4" diameter .090" anodized railings
- Hidden wall seams
- Non-skid strips for doorways
- Plush textured carpet
- Mural graphics package

Convenience

- Four stainless cleat and lifting eye assembly
- Oval table with cup holders
- 24 gallon fuel system
- Moveable cup holders
- Large rear storage compartment with door

Canvas and Top

- 10' Bimini top with boot
- Transport position support brackets
- Bimini quick release pull pins

Construction

- 8 1/2' wide
- 25" diameter pontoons
- Heavy duty 3" reinforced deck rail
- Heavy duty C-channel crossbeams
- Corner castings all four corners
- Extra heavy duty motor pod double bolted with 3/8" SST bolts attached to seven crossbeams
- Gate latches with stainless steel insert and welded safety tab
- LT Fish Additional Features
- Two fish chairs
- Livewell under bow bench

INTERIOR OPTIONS

CRUISE

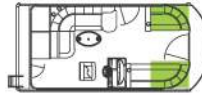

19'

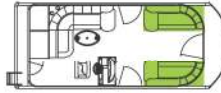

21'

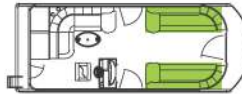

23'

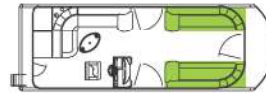

25'

FISH

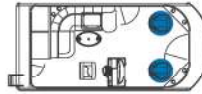

19'

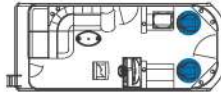

21'

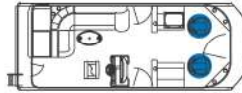

23'

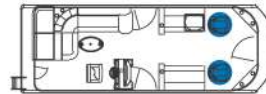

25'

OPTIONS

- Tilt steering
- Baystar steering
- Buckskin vinyl
- Built in docklights
- Chrome housing for built in docklights
- Windshield
- Colored wall skin
- Ski tow bar
- 28 oz. Escalade hi-lo carpet
- Vinyl flooring
- Privacy station curtain and frame conversion for storage area
- Color matched playpen cover
- Seat covers

SPECIFICATIONS

LENGTH	19'	21'	23'	25'
Pontoon Diameter	25"	25"	25"	25"
Width	8 1/2'	8 1/2'	8 1/2'	8 1/2'
Dry Weight	1,700	1,850	2,240	2,450
Max. Weight Cap.	1,930	2,035	2,150	2,530
Max. Engine HP	90	115	125	150
Max. # People	9	10	11	13
Max. People Lbs.	1,270	1,300	1,540	1,790



Some models shown with optional equipment.

Tahoe PONTOON BOATS

LT

THE NEW LT MODEL IS FOR THOSE WHO WANT TAHOE QUALITY AT A GREAT VALUE

This is a beautiful boat that is made with the same care and quality materials used on all Tahoe pontoon boats. We include many of Tahoe's nicest features – plush Matrix 50 furniture, 25" pontoons, 8 1/2 wide body, 10' bimini top, 28 oz. Escalade carpet and radius front deck at an amazing price!

LT 25' Cruise

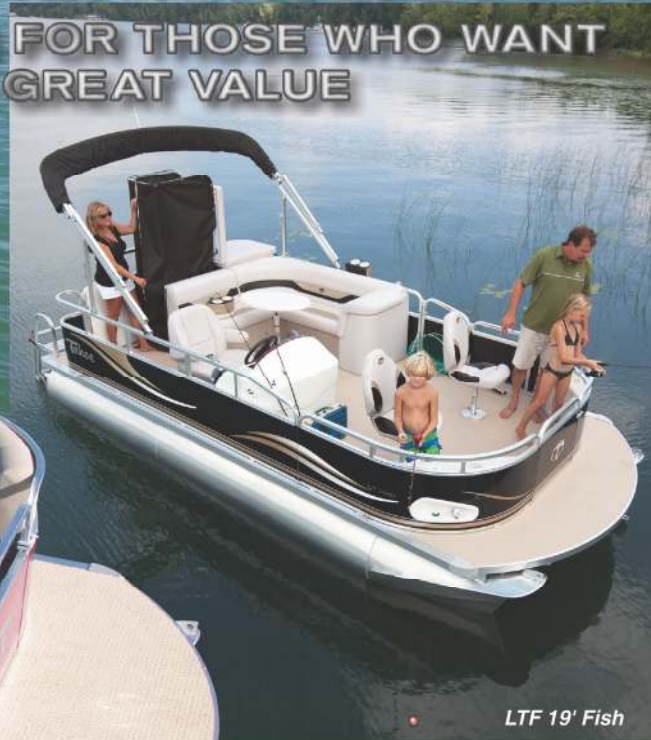

LTF 19' Fish

2012
Tahoe
PONTON BOATS

PROMOTIONAL MODEL





Tahoe PONTON BOATS



- 1 Aluminum deck
- 2 Camper enclosure – full (22' & Up)
- 3 Camper enclosure – half with bow cover
- 4 Camper enclosure – half
- 5 Escalade carpet
- 6 Islands carpet
- 7 Raised platform
- 8 Chair – Captain
- 9 Chair – Commander recliner
- 10 Chair – Admiral recliner
- 11 Chair – Admiral doublewide
- 12 Chair – sport barrel
- 13 Convenience center
- 14 Playpen cover
- 15 Seat covers
- 16 Cup holder lighted
- 17 Cup holder portable
- 18 Dinette port bow – 22' & up (except CF & AF)
- 19 Fishfinder Garmin 200 (not GPS)
- 20 Fishfinder Garmin 500c (not GPS)
- 21 GPS/Fishfinder Garmin 431S or upgrade to Coastal 441S
- 22 Gas grill
- 23 Light – engine compartment
- 24 Lights – mood
- 25 Lights – rubrail
- 26 Lights – rear underwater
- 27 Livewell under bench
- 28 MSR 2107 stereo
- 29 Premium sound system
- 30 Refreshment center Commander
- 31 Refrigerator center
- 32 Table – round plastic
- 33 Table – oval plastic
- 34 Table – kidney thermal form
- 35 Table – small round cocktail smoked glass
- 36 Table – large round smoked glass





- 37 Table – curved smoked glass
- 38 Table – rectangular smoked glass
- 39 Trash can for lounge arm
- 40 Simulated teak – rear entry
- 41 Simulated teak – front deck
- 42 Simulated teak – full deck
- 43 Top – dual Bimini 20' & up
- 44 Top – Funship
- 45 In floor ski locker with light – center pontoon only
- 46 Umbrella for table
- 47 Vinyl flooring
- 48 Snap in carpet
- 49 Washdown kit
- 50 Wine Rack for lounge arm



Tahoe PONTON BOATS

INTERIOR COLORS

Main	Accent	Pipe Trim	Carpet
BLUEONCE			
SAGE			
BLACK			
RED			
TOPAZ			
YELLOW			
BURGUNDY			
BROWN			
NAVY			
GREEN			

BASE VINYL OPTIONS



WALL COLORS

SOLID WALL COLORS



DECO TWO TONE WALL COLORS

VISION ONLY
Color combination cannot be altered

ALL OTHER DECO SERIES
Rear section color can be altered to any color shown

Front Wall		Rear Section	
WHITE		BLACK	
BLACK		WHITE	
BURGUNDY		BLACK	
BLUE		WHITE	
CHAMPAGNE		BLACK	
RED		WHITE	
GREEN		WHITE	
SILVER		BLACK	

Front Wall		Rear Section	
WHITE		WHITE	
WHITE		BLACK	
BLACK		WHITE	
BURGUNDY		BLACK	
BLUE		WHITE	
CHAMPAGNE		BLACK	
RED		BLACK	
GREEN		WHITE	

Tahoe
PONTOON BOATS



THE CERTIFIED ADVANTAGE

The NMMA Certified label on a Tahoe Pontoon boat lets you know it was built to meet and often exceed, the industry's strictest quality and safety standards for critical components such as electrical systems, powering, flotation, fuel systems and navigation lights. Certified boats must also pass rigorous annual inspections from independent third-party inspectors. According to U.S. Coast Guard statistics NMMA Certified boats have been shown to be safer than non-certified boats.

NMMA[®]
CERTIFIED ✓
 using **ABYC** standards

MATRIX 50

Tested Strongest

Tahoe's exclusive MATRIX 50 heavy duty 50 ounce marine seat coverings with a 24% substructure is tested strongest against tears, punctures and stains.



Dimensions, capacities, ratings and additional specifications plus complete warranty and service information are available from your Tahoe dealer. Product illustrations and data within this catalog are based upon information available at the time of publication. Tahoe reserves the right to make changes without notice or obligation. Ask your local Tahoe dealer for the most current product specifications prior to purchase. Some of the equipment shown separately or on products illustrated in this catalog may be optional at extra cost. All Tahoe boats meet or exceed the standards established by the ABYC and USCG flotation, fuel systems, ventilation, electrical and safety.



Graphic design by
 The F.P. Horak Company
www.fphorak.com

www.tahoe pontoons.com

marine industry
CSI
 award
 2011
 Excellence in Customer Satisfaction

Tahoe's superior customer satisfaction is recognized by the **NMMA CSI AWARD** for 2008, 2009, 2010 and 2011!

Tahoe
 Pontoons[®]

903 Michigan Avenue, Alma, Michigan 48801
 Worldwide: 800.334.2913 • 989.463.2112 • Fax: 989.463.8226

© 2012