

# FUSION<sup>®</sup> Apollo<sup>™</sup> MS-RA770

OWNER'S MANUAL



ENGLISH

**FUSION<sup>®</sup>**  
FUSIONENTERTAINMENT.COM

© 2019 Garmin Ltd. or its subsidiaries

All rights reserved. Under the copyright laws, this manual may not be copied, in whole or in part, without the written consent of Garmin. Garmin reserves the right to change or improve its products and to make changes in the content of this manual without obligation to notify any person or organization of such changes or improvements. Go to [www.fusionentertainment.com](http://www.fusionentertainment.com) for current updates and supplemental information concerning the use of this product.

Garmin®, ANT®, Fusion®, and the Fusion logo are trademarks of Garmin Ltd. or its subsidiaries, registered in the USA and other countries. Apollo™, Connect IQ™, Fusion-Link™, Fusion-Link Lite™, and Fusion PartyBus™ are trademarks of Garmin Ltd. or its subsidiaries. These trademarks may not be used without the express permission of Garmin.

Apple®, AirPlay®, iPhone®, and iPod touch® are trademarks of Apple Inc., registered in the USA and other countries. App Store™ is a service mark of Apple Inc., registered in the USA and other countries. Android™ and Google Play™ are trademarks of Google Inc. Bluetooth® word mark and logos are owned by the Bluetooth SIG, Inc. and any use of such marks by Garmin is under license. NMEA 2000®, and the NMEA 2000 logo are registered trademarks of the National Marine Electronics Association. SiriusXM®, SportsFlash™, TuneMix™, TuneStart™, and all related marks and logos are trademarks of Sirius XM Radio Inc. All rights reserved. Wi-Fi® is a registered mark of Wi-Fi Alliance Corporation. Other trademarks and trade names are those of their respective owners.

# Table of Contents

<b>Getting Started</b>	<b>1</b>		
Stereo Controls	1		
Playback Controls	1		
Gesture Screen	1		
Entering Text	1		
Using the Dial to Select Items	1		
Stereo Screen	1		
Control Screen	2		
Status Icons	2		
Naming the Device	2		
Setting the Home Zone	2		
Temporarily Selecting a Stereo to Control	2		
Selecting a Source	2		
Adjusting the Backlight and Dial Brightness	2		
Enabling Standby Mode	2		
<b>Audio Control</b>	<b>2</b>		
Adjusting the Volume	2		
Muting all Connected Stereos	3		
Adjusting the Subwoofer Level	3		
Synchronizing the Source and Zone Volume Levels	3		
Adjusting the Gain for an Auxiliary Device	3		
Speaker Zones	3		
DSP Settings	3		
Configuring the DSP Settings	3		
<b>Media Player Connection</b>	<b>3</b>		
<b>Bluetooth Device Playback</b>	<b>3</b>		
Connecting a Compatible Bluetooth Device	4		
Bluetooth Range Information	4		
Selecting a Different Bluetooth Device	4		
Bluetooth Source Menu and Settings	4		
<b>USB Device Playback</b>	<b>4</b>		
USB Device Compatibility	4		
Connecting a USB Device	4		
Controlling Music Playback on a USB Source	4		
Controlling Music Playback on a Connected Android Device, USB Flash Drive, or Media Player	5		
Controlling Music Playback on a Connected Apple Device	5		
USB Source Menu and Settings	5		
<b>Radio</b>	<b>5</b>		
Setting the Tuner Region	5		
Changing the Radio Station	5		
<b>Apple AirPlay</b>	<b>5</b>		
Connecting an Apple Device Using AirPlay	5		
Setting an AirPlay Password	5		
<b>UPnP Playback</b>	<b>5</b>		
Connecting a UPnP Device	6		
<b>Connecting an Auxiliary Device</b>	<b>6</b>		
<b>Optical Audio Connection</b>	<b>6</b>		
<b>SiriusXM Satellite Radio</b>	<b>6</b>		
Setting the Tuner Region for the SiriusXM Source	6		
Locating the SiriusXM Radio ID	6		
Activating a SiriusXM Subscription	6		
Selecting a Category	6		
Using Replay Mode	6		
Alerts	6		
Adding an Artist or Song Alert	6		
Adding Teams for Game Alerts	6		
Adding Teams from a Live Game	7		
Viewing Active Alerts	7		
Managing Alerts	7		
TuneMix™ Feature	7		
Starting and Stopping a TuneMix Collection	7		
Creating and Customizing a TuneMix Collection	7		
SportsFlash Feature	7		
Adding Teams to Receive SportsFlash Alerts	7		
Changing SportsFlash Team Priority	7		
Enabling the TuneStart™ Feature	7		
Parental Controls	8		
Unlocking the Parental Controls	8		
Locking Channels	8		
Clearing All Locked Channels	8		
Changing the Parental Control Passcode	8		
SiriusXM Troubleshooting	8		
Clearing SiriusXM Data	8		
Connecting an Apple Device Using AirPlay	8		
Setting an AirPlay Password	9		
<b>DAB Playback</b>	<b>9</b>		
Setting the Tuner Region	9		
Scanning for DAB Stations	9		
Changing DAB Stations	9		
Selecting a DAB Station from a List	9		
Selecting a DAB Station from a Category	9		
<b>Presets</b>	<b>9</b>		
Saving a Station as a Preset	9		
Selecting a Preset from a List	9		
Removing Presets	9		
<b>Fusion PartyBus Networking</b>	<b>9</b>		
Creating a Group	9		
Editing a Group	10		
Leaving a Group	10		
Network Source Considerations	10		
<b>General Settings</b>	<b>10</b>		
Speaker Zone Settings	10		
Disabling the Internal Amplifiers	10		
Disabling a Zone	10		
Enabling Volume Control of Zone 3 or 4 from a Connected Amplifier	10		
Linking Zones	10		
Disabling the Loud Setting for a Zone	11		
Adjusting the Tone	11		
Setting a Zone Name	11		
Adjusting the Subwoofer Filter	11		
Adjusting Additional Audio Settings for a Zone	11		
Power Options	11		
Network Settings	11		
Connecting the Fusion PartyBus Device to a Wireless Access Point	11		
Connecting the Device to a Wireless Access Point Using Wi-Fi Protected Setup	12		
Connecting the Device to a Wireless Access Point Using Apple Wireless Accessory Configuration	12		
Setting the Fusion PartyBus Device as a Wireless Access Point	12		
Wireless Access Point Settings	12		
Advanced Network Configuration	12		
Setting the Fusion PartyBus Device as the DHCP Server	12		
Configuring the Stereo for use with a Garmin Marine Network	13		
Setting a Static IP Address	13		
Resetting Network Settings	13		
Update Options	13		
<b>Additional Stereo Control Options</b>	<b>13</b>		
Connecting to a Garmin Watch	13		

Connecting to an ARX70 Remote Control	13
Fusion-Link Wireless Remote Control App	14
FUSION-Link™ Network Technology	14
NMEA 2000 Remote Control and Display	14
Configuring an Optional Wired NRX Remote Control	14
NMEA 2000 Information	14
<b>Appendix</b>	<b>14</b>
Cleaning the Device	14
Software Updates	14
Updating the Software Using a USB Flash Drive	14
Updating the Software Using the Fusion Link App	15
Registering Your Apollo RA770	15
Troubleshooting	15
The stereo does not respond to key presses	15
My Bluetooth audio is interrupted by short breaks	15
The stereo does not display all song information from my Bluetooth source	15
Network Troubleshooting	15
Network Status Icons	15
The stereo keeps locking up when connected to an Apple device	16
The stereo is not finding my connected Apple device	16
My Apple AirPlay audio is interrupted by short breaks	16
Specifications	16
Stereo Dimension Drawings	16
Side Dimensions	16
Top Dimensions	16
<b>Index</b>	<b>17</b>

# Getting Started

## ⚠ WARNING

See the *Important Safety and Product Information* guide in the product box for product warnings and other important information.

## Stereo Controls

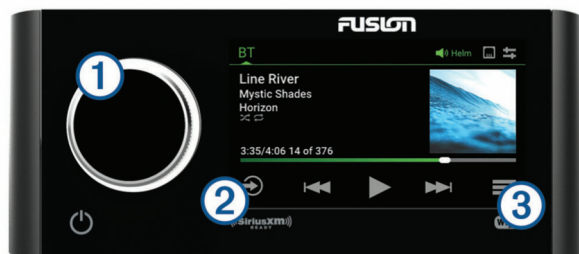

① Dial	<ul style="list-style-type: none"> <li>Turn to adjust the volume.</li> <li>When adjusting the volume, press to switch between zones.</li> <li>Turn or press to open the CONTROL screen to select and group stereos (<a href="#">Control Screen, page 2</a>).</li> <li>Turn to move through the menus or adjust a setting.</li> <li>When in a menu, press to select the highlighted option.</li> <li>Press and hold to activate certain functions such as opening the radio presets or muting all connected stereos from the mute screen (<a href="#">Muting all Connected Stereos, page 3</a>).</li> </ul>
②	<p>Press to change the source.</p> <p><b>TIP:</b> You can turn the dial to browse, and press the dial to select the source. You can also swipe the screen up and down, and touch a source on the screen.</p>
③	<p>Press to open a menu for the current source.</p> <p>Not available on all sources.</p>
⚙️	<p>Press to open the stereo settings menu.</p> <p>Available on the stereo screen or in the menu for some sources.</p>
⏻	<ul style="list-style-type: none"> <li>Press to turn on the stereo.</li> <li>Press to mute the audio.</li> <li>Press and hold to turn off the stereo.</li> </ul>

## Playback Controls

The on-screen playback controls may change depending on the source selected.

**NOTE:** After playing media for about five seconds, the playback controls are hidden by the gesture screen feature. You can swipe down on the screen to view the playback controls ([Gesture Screen, page 1](#)).

⏸	Select to pause media playback.
▶	<ul style="list-style-type: none"> <li>Select to play media or resume media playback.</li> <li>DAB source: press to scan for DAB stations.</li> </ul>
⏮	<ul style="list-style-type: none"> <li>Select to skip to the previous track, when using an applicable source.</li> <li>Hold to rewind the track when using an applicable source.</li> <li>AM, FM, or SiriusXM (in Live Mode) source: <ul style="list-style-type: none"> <li>Select to tune to the previous station or preset.</li> <li>Hold for faster tuning (manual mode only).</li> </ul> </li> <li>SiriusXM (in Replay Mode) source: <ul style="list-style-type: none"> <li>Select to skip to the previous track.</li> <li>Hold to rewind the current track.</li> </ul> </li> <li>DAB source: Select to return to the previous DAB station in the ensemble. When you reach the beginning of the current ensemble, the stereo automatically changes to the last available station in the previous ensemble.</li> </ul>

⏭	<ul style="list-style-type: none"> <li>Select to skip to the next track, when using an applicable source.</li> <li>Hold to fast-forward the track when using an applicable source.</li> <li>AM, FM, or SiriusXM (in Live Mode) source: <ul style="list-style-type: none"> <li>Select to tune to the next station or preset.</li> <li>Hold for faster tuning (manual mode only).</li> </ul> </li> <li>SiriusXM (in Replay Mode) source: <ul style="list-style-type: none"> <li>Select to skip to the next track, if applicable.</li> <li>Hold to fast-forward the current track, if applicable.</li> </ul> </li> <li>DAB source: Select to advance to the next DAB station in the ensemble. When you reach the end of the current ensemble, the stereo automatically changes to the first available station in the next ensemble.</li> </ul>
MA (AM, FM, or DAB sources)	Select to cycle through the tuning modes (auto or manual) and presets. Press and hold to save the current station as a preset.
MIC (SiriusXM source)	Hold to switch between Replay Mode and Live Mode ( <a href="#">Using Replay Mode, page 6</a> ). Replay Mode: press to pause and play the channel. Live Mode: Select to cycle through the tuning modes (manual or category) and presets.
+	On the Aux or Optical source, select to increase the gain for the connected source.
-	On the Aux or Optical source, select to decrease the gain for the connected source.

## Gesture Screen

After playing media for about five seconds, a screen appears showing track information and album art only. You can use the touchscreen to interact with this screen.

- You can swipe left or right to change the track or preset.
- You can touch the screen for about one second to pause playback or mute the audio, depending on the source.
- You can swipe down to return to the playback controls screen.

**NOTE:** You can disable this screen in the settings ([Power Options, page 11](#)).

## Entering Text

- In a field that allows you to enter text, select ✕ to erase the existing characters.
- If necessary, select ◀ or ▶ to use numerals or letters.
- If necessary, select ▲ to change the case.
- Touch a character to select it.
- Select ✓ to save the new text.

## Using the Dial to Select Items

You can use the dial to highlight and select items on the screen.

- Turn the dial to highlight an item on the screen.
- Press the dial to select the highlighted option.

## Stereo Screen

The information displayed on the screen varies depending on the source selected. The on-screen playback controls may change depending on the source selected ([Playback Controls, page 1](#)). This example shows a track playing on a device connected using Bluetooth® wireless technology.

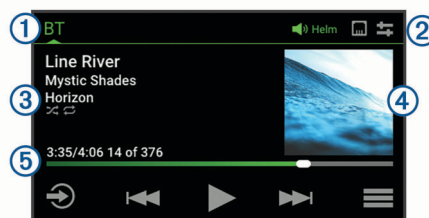

①	Source name
②	Active zone, status icons, and shortcuts ( <i>Status Icons</i> , page 2) <b>TIP:</b> Touch an icon to open the applicable page.
③	Track details (if available)
④	Album art (if available from a compatible source)
⑤	Elapsed time, track duration, and the current track number out of the total number of tracks in the playlist (if available)

## Control Screen

From the CONTROL screen, you can adjust the volume of any zone on the network, create and edit stereo groups, and choose a stereo to control.

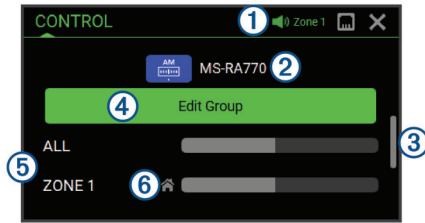

①	Name of the stereo or zone on the network currently being controlled by this device
②	Name and active source of a stereo on the network
③	Indicates that additional zones or stereos can be seen when you scroll through the list
④	Select to add or remove stereos from a group ( <i>Creating a Group</i> , page 9)
⑤	Available speaker zones for network stereos If you scroll down, additional zones are shown under the names of other stereos on the network
⑥	Home zone indicator ( <i>Setting the Home Zone</i> , page 2)

## Status Icons

You can touch a status icon to open the relevant screen.

	Opens the CONTROL screen.
	Opens the PRESET screen.
	Opens the network settings.

## Naming the Device

You should enter a unique name for this device so you can easily identify it when viewing devices on the Fusion PartyBus™ network.

**NOTE:** You should provide unique names to all of the devices and zones on the network to avoid confusion when grouping, controlling, and setting up stereos and zones. You should also turn off zones that are not in use (*Speaker Zone Settings*, page 10).

For further customization, you can provide unique names for the sources on each stereo and turn off unused sources (*General Settings*, page 10).

- 1 Select > .
- 2 Select **DEVICE NAME**, and enter a unique name for the device.

## Setting the Home Zone

The home zone is the speaker zone that you adjust by default when you turn the dial.

- 1 Select > .
- 2 Select **ZONE > ASSIGN HOME ZONE**.
- 3 Select a zone.

## Temporarily Selecting a Stereo to Control

If you have more than one compatible stereo on the Fusion PartyBus network, you can temporarily select one of them to control using this stereo.

**NOTE:** You can also combine compatible stereos on the network into groups for synchronized playback (*Creating a Group*, page 9).

- 1 Press the dial to open the **CONTROL** screen.
- 2 Turn the dial, and select the stereo or zone you want to control using this device.

The name of the stereo or zone appears on the status bar, and you can change sources, settings, and adjust the volume for the selected stereo or zone.

After about 30 seconds of inactivity, the stereo reverts to local control or to the stereo associated with the home zone.

## Selecting a Source

- 1 Select .
- 2 Turn the dial to highlight a source.

**NOTE:** If the device is part of a group on the Fusion PartyBus network, continue turning the dial to access the sources on other devices in group (*Creating a Group*, page 9).

A zone stereo, such as the Apollo SRX400, can create or join a group to control and play sources from other stereos, but it cannot share its sources with the group.

- 3 Press the dial to select the source.

## Adjusting the Backlight and Dial Brightness

**NOTE:** If you connected the dim wire on the wiring harness to the boat's illumination wire, the backlight and dial dim automatically when the boat lights are on. This may affect how you adjust the brightness setting.

- 1 Select > > **BRIGHTNESS**.
- 2 Adjust the brightness level.

## Enabling Standby Mode

By default, when you turn off the ignition (when connected) or hold , the device turns off, and you must press to turn it on again.

You can set the stereo to enter a standby mode when you turn off the ignition (when connected) or hold . When you turn on the ignition or press again, it takes less than the typical 30 seconds to turn on than with standby mode disabled.

You can enable standby mode on the device so you can turn it on using another device on the network instead of pressing .

**NOTE:** When the device is off, it continues to draw approximately 80 mA from the battery. When you enable standby mode, the device draws more current because it is listening for a power-on signal over the network. When the device is off with standby mode enabled, it continues to draw approximately 110 mA.

Select > > **POWER OPTIONS > STANDBY MODE**.

The stereo now enters standby mode when you hold or turn off the ignition. You can turn it on again from the CONTROL screen on any device on the network.

## Audio Control

### Adjusting the Volume

You can control the volume of any zone on any stereo connected to the Fusion PartyBus network.

- 1 Turn the dial to adjust the volume.
- 2 If necessary, press the dial to switch between zones.

**TIP:** You can select ALL to adjust the volume for all zones of all grouped stereos at the same time.

### Muting all Connected Stereos

You can quickly mute the audio from this stereo or from all stereos connected to the Fusion PartyBus network (*Fusion PartyBus Networking, page 9*).

- 1 From any source, press .  
The mute symbol appears and audio from this stereo is silenced.  
**NOTE:** If the stereo is part of a group, the audio from all grouped stereos is silenced.
- 2 Select **MUTE SYSTEM**.  
Audio from all connected stereos is silenced.
- 3 Select **UNMUTE SYSTEM**.  
Audio is restored to all connected stereos.

### Adjusting the Subwoofer Level

You can adjust the subwoofer level for each zone.

- 1 Press the dial to open the **CONTROL** screen.
- 2 Turn the dial to select a zone.
- 3 Press and hold the dial.  
The SUB LEVEL adjustment for the zone appears.
- 4 Turn the dial to adjust the subwoofer level.

### Synchronizing the Source and Zone Volume Levels

You can synchronize the volume levels on one or all zones with some source devices, such as a Bluetooth source.

- 1 Select  >  > **ZONE** > **PHONE VOLUME ZONE SYNC**.
- 2 Select a zone or **ALL**.

When you adjust the volume on the source device, the volume on the selected zone is also adjusted.

### Adjusting the Gain for an Auxiliary Device

You can adjust the gain for a connected auxiliary device to achieve a volume level similar to that of other media sources. You can adjust the gain in 1 dB increments. You can also adjust the gain for digital sources using an optical audio connection.

- 1 Select an auxiliary source.
- 2 Select an option:
  - To increase the gain, select **+**.
  - To decrease the gain, select **-**.

**NOTE:** To achieve the best audio quality when using a portable media player with headphone output, it may be necessary to adjust the volume control on the media player, instead of adjusting the gain.

### Speaker Zones

You can group speakers in one area into a speaker zone. This enables you to control the audio level of the zones individually. For example, you could make the audio quieter in the cabin and louder on deck.

You can set the balance, volume limit, tone, subwoofer level, subwoofer frequency, and name for each zone, and configure other zone-specific settings (*Speaker Zone Settings, page 10*).

### DSP Settings



This stereo features digital signal processing (DSP). You can select pre-configured DSP settings for Fusion® speakers and amplifiers to optimize audio reproduction in their installed locations.

All DSP settings are configured using the Fusion-Link™ remote control app (*Fusion-Link Wireless Remote Control App, page 14*).

### Configuring the DSP Settings

You must download and install the Fusion-Link remote control app on your compatible Apple® or Android™ device before you can configure the DSP settings (*Fusion-Link Wireless Remote Control App, page 14*).

You can configure the DSP settings to optimize the sound on each zone with the installed speakers, amplifiers, and environment.

- 1 From the settings menu on your Apple or Android device, connect to the stereo using Bluetooth technology, or connect to the same wireless network as the stereo.
- 2 Open the Fusion-Link remote control app on your compatible Apple or Android device.
- 3 If necessary, select the stereo you want to configure.
- 4 Select .
- 5 If necessary, select the **MUSIC** tab.
- 6 Select **Zone**.
- 7 Select a zone.
- 8 Select **DSP SETTINGS**.
- 9 Configure the DSP settings as needed, depending on the models of Fusion speakers and amplifiers connected to the zone.
- 10 Repeat these steps for each zone.
- 11 After you have finished configuring the DSP settings for all zones, select an option:
  - On an Apple device, select  > **Zone** > **SETTINGS** > **SEND DSP SETTINGS**
  - On an Android device, select  > **Zone** > **SEND DSP SETTINGS**.

## Media Player Connection

### CAUTION

Always disconnect your media player from the stereo when not in use and do not leave it in your vessel. This helps reduce the risk of theft and damage from extreme temperatures.

Do not remove the media player or use your stereo in a distracting manner while operating the vessel. Check and obey all marine laws in association with use.

The stereo accepts a variety of media players, including smartphones and other mobile devices. You can connect a compatible media player using a Bluetooth wireless connection or a USB connection to the USB port. The stereo can play media from Universal Plug and Play (UPnP) devices, such as a Network Attached Storage (NAS) device connected to the same network. The stereo can play media from a compatible Apple device connected to the same network using the AirPlay® feature.

## Bluetooth Device Playback

You can pair the stereo to up to eight Bluetooth media devices.

You can control the playback using the stereo controls on all Bluetooth devices, and on some devices you can browse the music collection from the menu on the stereo. On Bluetooth devices that do not support media browsing, you should select the song or playlist on the media device.

The availability of song information such as song title, artist name, track duration, and album art depends on the capability of the media player and music application.

## Connecting a Compatible Bluetooth Device

You can play media from a compatible Bluetooth device using the Bluetooth wireless connection.

You can control the music playback with the media app on a Bluetooth device or using the Fusion-Link remote control app (*Fusion-Link Wireless Remote Control App, page 14*).

- 1 Select the **BT** source.
- 2 Select  > **DISCOVERABLE** to make the stereo visible to your compatible Bluetooth device.
- 3 Enable Bluetooth on your compatible Bluetooth device.
- 4 Bring the compatible Bluetooth device within 10 m (33 ft.) of the stereo.
- 5 On your compatible Bluetooth device, search for Bluetooth devices.
- 6 On your compatible Bluetooth device, select the stereo from the list of detected devices.
- 7 On your compatible Bluetooth device, follow the on-screen instructions to pair and connect to the discovered stereo.  
When pairing, your compatible Bluetooth device may ask you to confirm a code on the stereo. The stereo does not display a code, but it does connect correctly when you confirm the message on the Bluetooth device.
- 8 If your compatible Bluetooth device does not immediately connect to the stereo, repeat steps 1 through 7.

The DISCOVERABLE setting is disabled automatically after two minutes.

**NOTE:** On some Bluetooth devices, adjusting the volume on the device affects the volume level on the stereo.

### Bluetooth Range Information

The stereo and Bluetooth wireless devices have a range of 10 m (33 ft.). For optimal performance, the Bluetooth wireless device should also have a clear line of sight to the stereo.

### Selecting a Different Bluetooth Device

When you have more than one Bluetooth device paired to the stereo, you can select a different source when needed. You can pair the stereo with up to eight Bluetooth devices.

- 1 With the **BT** source selected, select .
- 2 Select a Bluetooth device.

### Bluetooth Source Menu and Settings

With the BT source selected, select .

**NOTE:** The options in this menu vary based on the connected device.

**DISCOVERABLE:** Allows the stereo to be visible to Bluetooth devices. You can turn off this setting to prevent possible interruption to audio after pairing a Bluetooth device to the stereo.

**REMOVE DEVICE:** Removes the Bluetooth device from the stereo. To listen to audio from this Bluetooth device again, you must pair the device again.

**REPEAT OFF:** Sets the repeat mode for the current selection. You can repeat the current selection by selecting the REPEAT ONE option. You can repeat all items in the selection by selecting the REPEAT ALL option.

**SHUFFLE OFF:** Shuffles the tracks in the folder, album, or playlist.

**PLAYLIST:** Displays the playlists on the device.

**ARTISTS:** Displays the artists on the device.

**ALBUMS:** Displays the albums on the device.

**GENRES:** Displays the genres of music on the device.

**SONGS:** Displays the songs on the device.

## USB Device Playback

You can connect various USB media players, USB flash drives, and smartphones to the stereo. How you access the USB source depends on the type of connected media player or smartphone.

Media Player	Source Selections
Android device	MTP
Apple device	iPod
USB flash drive	USB
MP3 media player (as a mass-storage device)	USB <b>NOTE:</b> If your MP3 media player does not support mass-storage when connected using USB, you must connect it to the stereo as an auxiliary device ( <i>Connecting an Auxiliary Device, page 6</i> ).

You can control the playback using the stereo controls on all USB devices, and on some devices you can browse the music collection from the menu on the stereo. On USB devices that do not support media browsing, you should select the song or playlist on the media device.

The availability of song information such as song title, artist name, and track duration depends on the capability of the media player and music application.

### USB Device Compatibility

You can use a USB flash drive or the USB cable included with your media player to connect a media player or mobile device to the USB port.

The stereo is compatible with iAP2 Apple devices such as the iPhone® Xs Max, iPhone Xs, iPhone XR, iPhone X, iPhone 8 Plus, iPhone 8, iPhone 7 Plus, iPhone 7, iPhone SE, iPhone 6s Plus, iPhone 6s, iPhone 6 Plus, iPhone 6, iPhone 5s, and iPod touch® (6th generation).

The stereo is compatible with Android devices that support MTP mode.

The stereo is compatible with media players and other USB mass storage devices, including USB flash drives. Music on USB drives must meet these conditions:

- The music files must be formatted as MP3, AAC (.m4a), or FLAC, files.
- If you connect a portable hard drive, you must connect it to an external power source. The USB port on this stereo cannot provide power for a portable hard drive.
- The USB mass storage device must be formatted using one of the following systems:
  - Microsoft®: NTFS, VFAT, FAT<sup>1</sup>, MSDOS
  - Apple: HFS, HFSPLUS
  - Linux: EXT2, EXT3, EX4

### Connecting a USB Device

You can connect a USB device to the USB port on the stereo.

- 1 Locate the USB port on the back of the stereo.
- 2 Connect the USB device to the USB port.
- 3 Select the USB source.

### Controlling Music Playback on a USB Source

- 1 Connect a compatible USB device to the stereo.
- 2 Select the appropriate source.
- 3 If necessary, select  to browse the music on the USB device.

<sup>1</sup> FAT includes most types of FAT file systems except exFAT.



- 4 If necessary, launch a music application on the USB device, and begin playback.

You can use the stereo controls to select, play, pause, and skip tracks.

## Controlling Music Playback on a Connected Android Device, USB Flash Drive, or Media Player

- 1 Connect a compatible Android device, USB flash drive, or media player to the stereo.
- 2 Select the appropriate source on the stereo.
- 3 Select .
- 4 If necessary, select the name of the device or USB drive to view the file structure.
- 5 Select a song to begin music playback.

You can use the stereo controls to select, play, pause, and skip tracks.

## Controlling Music Playback on a Connected Apple Device

- 1 Connect a compatible Apple smartphone or media player to the stereo using USB or Bluetooth (if available).
- 2 Select the appropriate source on the stereo.
- 3 Launch a music application on the connected device, and begin playback.

You can use the music application or the stereo controls to browse the music library and to select, play, pause, and skip tracks.

## USB Source Menu and Settings

With a USB source selected, select .

**NOTE:** You can browse the files on the device using this menu. The options in this menu vary based on the connected device.

**REPEAT OFF:** Sets the repeat mode for the current selection.

You can repeat the current selection by selecting the REPEAT ONE option. You can repeat all items in the selection by selecting the REPEAT ALL option.

**SHUFFLE OFF:** Shuffles the tracks in the folder, album, or playlist.

## Radio

To listen to AM or FM radio, you must have a suitable marine AM/FM antenna properly connected to the stereo and be within range of a broadcasting station. For instructions on connecting an AM/FM antenna, see the stereo installation instructions.

To listen to SiriusXM® radio, you must have the appropriate equipment and subscriptions (*SiriusXM Satellite Radio*, page 6). For instructions on connecting a SiriusXM Connect Vehicle Tuner, see the stereo installation instructions.

To listen to DAB stations, you must have the appropriate equipment (*DAB Playback*, page 9). For instructions on connecting a DAB adapter and antenna, see the installation instructions provided with your adapter and antenna.

## Setting the Tuner Region



You must select the region you are in to receive AM and FM stations properly.

If you are connected to a compatible SiriusXM tuner and antenna, and have a subscription (USA only), you must select the region you are in to receive SiriusXM stations properly.



**NOTE:** SiriusXM is not available in all regions.



If you are connected to a compatible DAB module and antenna (not included), you must select the region you are in to receive DAB stations properly.

**NOTE:** DAB stations are not available in all regions.

- 1 Select  >  > **TUNER REGION**.
- 2 Select the region you are in.

## Changing the Radio Station

- 1 Select an applicable source, such as **FM**.
- 2 Select  repeatedly to move through the tuning modes, and select an option:
  - Select **AUTO** to scan and stop on the next available station.
  - Select **MANUAL** to select a station manually.
  - Select **PRESET** to select a saved station preset.
- 3 Select  or  to tune to the station.



When in MANUAL tuning mode, you can hold  or  to quickly advance through the stations.

## Apple AirPlay

### Connecting an Apple Device Using AirPlay

- 1 From the settings menu on your Apple device, connect to the same wireless network as your compatible Fusion stereo.

**NOTE:** You can connect some Apple devices to the network using a wired Ethernet connection, if applicable. Go to the Apple website for more information.

- 2 On your Apple device, open the music app you want to stream to the stereo.
- 3 From the music app or program, select  or , and select the name of the stereo.
- 4 If necessary, start playing music on the app.

The stereo changes to the AirPlay source automatically and plays audio from your Apple device.



**NOTE:** If your Apple device is using AirPlay 2 software, you can connect to multiple stereos on the same network.

**NOTE:** You cannot stream the AirPlay source to other stereos on the network using the Fusion PartyBus network (*Fusion PartyBus Networking*, page 9). Using AirPlay 2 software, you can play content on multiple stereos on the network, but the stereos must not be grouped.

**NOTE:** On some AirPlay devices, adjusting the volume on the device affects the volume level on the stereo.

### Setting an AirPlay Password

You can set a password that a user must enter when connecting to the stereo using the AirPlay feature.

- 1 Select  >  > **AirPlay PASSWORD**.
- 2 Enter a password.

**NOTE:** The AirPlay password is case-sensitive.

When connecting to this stereo using the AirPlay feature, the user must enter the password on their Apple device.

## UPnP Playback

This stereo can play content from Universal Plug and Play (UPnP) devices connected to the network, such as computers and media servers. You must connect your UPnP device to the same network as the stereo using a wired or wireless connection, and you must configure the device to share media over the network. See the owner's manual from your UPnP device for more information.

After you have connected your UPnP device to the network and configured it to share media, the UPnP source appears on the source selection screen of each stereo on the network (*Selecting a Source*, page 2).

## Connecting a UPnP Device

You must connect your stereo to a network to play media from a UPnP device, such as a NAS device.

- 1 Connect your UPnP device to the same network as the stereo, referring to the instructions provided with your UPnP device and router if necessary.
- 2 Select the UPnP source on the stereo (*Selecting a Source*, page 2).  
You can browse and play media from the UPnP device.

## Connecting an Auxiliary Device

You can connect various auxiliary devices to the stereo. These devices have either RCA connectors, a line output, or a headphone output jack.

- 1 Locate the auxiliary connectors on the wiring harness.
- 2 If necessary, connect an RCA-to-3.5 mm adapter cable to the auxiliary device.
- 3 Connect the auxiliary device to the AUX IN RCA connectors on the wiring harness.
- 4 Select the **Aux** source.

## Optical Audio Connection

You can connect devices with an optical audio output to the stereo using an optical audio cable. Televisions, DVD players, CD players, and other devices may supply digital optical audio output.

This stereo supports PCM audio only. You may have to change the settings on your device to output PCM audio.

**NOTE:** Because streaming audio over the Fusion PartyBus network introduces a slight delay, streaming content from a television or DVD player may not be ideal. You can disable Optical as a streaming source in the settings, if needed (*General Settings*, page 10).

## SiriusXM Satellite Radio

Only SiriusXM brings you more of what you love to listen to, all in one place. Get over 140 channels, including commercial-free music plus the best sports, news, talk, comedy and entertainment. Welcome to the world of satellite radio. A SiriusXM Vehicle Tuner and subscription are required. For more information, go to [www.siriusxm.com](http://www.siriusxm.com).

## Setting the Tuner Region for the SiriusXM Source

You must set the stereo to use the USA tuner region before you can listen to SiriusXM Satellite Radio.

- 1 Select  > .
- 2 Select **TUNER REGIONUSA**.

## Locating the SiriusXM Radio ID

You must have the radio ID of your SiriusXM Connect Tuner before you can activate your SiriusXM subscription. You can locate the SiriusXM Radio ID on the back of the SiriusXM Connect Tuner or its packaging, or by tuning your stereo to channel 0.

With the SiriusXM source selected, select  > **CHANNELS** > **ALL CHANNELS** > **000 RADIO ID**.

The SiriusXM Radio ID does not include the letters I, O, S, or F.

## Activating a SiriusXM Subscription

- 1 With the SiriusXM source selected, tune to channel 1.  
You should be able to hear the preview channel. If not, check the SiriusXM Connect Tuner and antenna installation and connections, and try again.
- 2 Tune to channel 0 to locate the Radio ID.
- 3 Contact SiriusXM listener care by phone at (866) 635-2349 or go to [www.siriusxm.com/activatenow](http://www.siriusxm.com/activatenow) to subscribe in the United States. Contact SiriusXM by phone at (877) 438-9677 or go to [www.siriusxm.ca/activatexm](http://www.siriusxm.ca/activatexm) to subscribe in Canada.
- 4 Provide the Radio ID.  
The activation process usually takes 10 to 15 minutes, but can take up to an hour. For the SiriusXM Connect Tuner to receive the activation message, it must be turned on and receiving the SiriusXM signal.
- 5 If the service is not activated within the hour, go to <http://care.siriusxm.com/refresh> or contact SiriusXM Listener Care by phone at 1-866-635-2349.

## Selecting a Category









You can control which categories of channels are available when using the CATEGORY tuning method.

- 1 With the SiriusXM source selected, select  > **CATEGORY**.
- 2 Select a category.

## Using Replay Mode

You can use Replay Mode to control playback of a SiriusXM broadcast.

**NOTE:** The device enables Replay Mode automatically when playing saved preset channels.

- 1 If necessary, hold  to enable Replay Mode.  
 changes to REPLAY MODE, and a progress bar appears.
- 2 Select an option:
  - Tap  to pause and resume playback.
  - Tap  or  to skip backward or forward in increments.  
**NOTE:** If you fast-forward or skip forward to the end of the progress bar, the stereo exits Replay Mode automatically.
  - Hold  or  to rewind or fast-forward the track.
  - Hold  to exit Replay Mode.

## Alerts

**NOTE:** The Artist, Song, and Game Alerts feature is compatible with the SXV300 tuner (sold separately). Other tuners are compatible, but may limit the features. Review the user manual supplied with your SiriusXM tuner to learn about features available with your tuner module.

### Adding an Artist or Song Alert

You can set alerts for artists and songs so that when a particular song or a song from a particular artist begins to play on any music channel, you can quickly tune to that channel.

- 1 While a particular song or a song from a particular artist is playing, select  > **ADD ALERT** > **SAVE ARTIST/SONG**.
- 2 Select the song or the artist.

### Adding Teams for Game Alerts

You can set alerts for sports teams so that when a game featuring a saved team begins to play on any sports channel, you can quickly tune to that channel.

**NOTE:** A Game Alert is different than a SportsFlash™ alert. A Game Alert lets you know when a game begins, while a

SportsFlash alert lets you know when an exciting play occurs during a game.

- 1 Select **≡** > **ADD ALERT** > **GAME ALERT TEAMS**.
- 2 Select a sports league.
- 3 Select a team to fill the check box and add a Game Alert.
- 4 Repeat steps 2 and 3 for each team you want to add to the list of Game Alerts.

### Adding Teams from a Live Game

While listening to a game, you can quickly add a team playing to your list of Game Alert teams.

- 1 While listening to a game on a channel, select **≡** > **ADD ALERT** > **SAVE TEAM**.  
A list of teams playing in the current game appears.
- 2 Select the team or teams to add to your list of Game Alert teams.

### Viewing Active Alerts

You can review active Artist, Song, and Game Alerts.

- 1 Select **≡** > **ACTIVE ALERTS**.
- 2 Select a category.

### Managing Alerts

You can manage your saved alerts to select which ones you want to receive. You can delete saved alerts you do not want.

- 1 Select **≡** > **SiriusXM SETTINGS** > **ALERT MANAGEMENT**.
- 2 Select an option:
  - To enable saved alerts for songs only, artists only, or games only, select **ENABLE BY TYPES**, and select a type.
  - To enable saved alerts for specific artists only, select **ENABLE ARTISTS**, and select the artists.
  - To enable saved alerts for specific songs only, select **ENABLE SONGS**, and select the songs.
  - To enable saved game alerts for specific teams, select **ENABLE TEAMS**, and select the teams.
  - To delete all saved alerts for songs, artists, or teams, select **DELETE BY TYPES**, and select a type.
  - To delete saved alerts for specific artists, select **DELETE ARTISTS**, and select the artists.
  - To delete saved alerts for specific songs, select **DELETE SONGS**, and select the songs.
  - To delete saved alerts for specific teams, select **DELETE TEAMS**, and select the teams.

### TuneMix™ Feature

**NOTE:** The TuneMix feature is compatible with the SXV300 tuner (sold separately). Other tuners are compatible, but may limit the features. Review the user manual supplied with your SiriusXM tuner to learn about features available with your tuner module.

### Starting and Stopping a TuneMix Collection

Before you can start playing a TuneMix collection, you must create one ([Creating and Customizing a TuneMix Collection, page 7](#)).

The TuneMix feature enables you to mix your favorite music channels to create a custom listening experience.

- 1 Select **≡** > **TUNEMIX**.
- 2 Select a TuneMix collection.  
The stereo begins playing the TuneMix collection.
- 3 To stop playing a TuneMix collection, select **≡** > **CHANNELS**, and select a channel.  
The stereo stops playing the TuneMix collection and begins playing the selected channel.

### Creating and Customizing a TuneMix Collection

You can create up to 10 unique TuneMix collections on the stereo.

**NOTE:** A TuneMix collection must include at least two of your favorite SiriusXM music channels.

- 1 Select **≡** > **SiriusXM SETTINGS** > **TUNEMIX SETUP**.
- 2 Select a TuneMix collection.
- 3 Select a channel to fill the check box and add it to the TuneMix collection.
- 4 After you are finished customizing the TuneMix collection, select **←**.
- 5 Repeat steps 2 through 4 for each TuneMix collection you want to customize.

### SportsFlash Feature

The SportsFlash feature alerts you to key plays from your favorite teams during a live game. When an exciting play happens, a SportsFlash alert appears, and you can tune to the broadcast and hear the play. When the SportsFlash alert ends, you can choose to return to the previous channel, or remain tuned to the game.

To receive SportsFlash alerts, your subscription package must include play-by-play sports channels for the sports leagues you want to include in the alerts.

You can enable, disable, or delete SportsFlash alerts that you have added ([Managing Alerts, page 7](#)).

**NOTE:** A SportsFlash is different than a Game Alert. A SportsFlash alert lets you know when an exciting play occurs during a game, while a Game Alert lets you know when a game begins.

**NOTE:** The SportsFlash feature is compatible with the SXV300 tuner (sold separately). Other tuners are compatible but may limit the features. Review the user manual supplied with your SiriusXM tuner to learn about features available with your tuner module.

### Adding Teams to Receive SportsFlash Alerts

- 1 Select **≡** > **SPORTSFLASH** > **TEAM SELECT**.
- 2 Select a sports league.
- 3 Select a team to fill the check box and add a SportsFlash alert.
- 4 Repeat steps 2 and 3 for each team you want to add to the list of SportsFlash alerts.

### Changing SportsFlash Team Priority

If more than one team for which you have set up SportsFlash alerts are playing at the same time, you can adjust the team priority to hear SportsFlash alerts from your preferred team first.

- 1 Select **≡** > **SPORTSFLASH** > **TEAM PRIORITIES**.  
A list of your selected SportsFlash teams appears, in order of priority.
- 2 Select a team to move it up one priority level in the list.
- 3 Repeat the previous step with each team you want to reorder until the priority list is ordered the way you prefer.

### Enabling the TuneStart™ Feature

When you enable the TuneStart feature and tune to a preset channel, the stereo starts the current song from the beginning of the song instead of starting it from the point it is at in the live broadcast.

**NOTE:** The TuneStart feature is available when tuning to preset channels only. The TuneStart feature is compatible with the SXV300 tuner (sold separately). Other tuners are compatible but may limit the features. Review the user manual supplied with your SiriusXM tuner to learn about features available with your tuner module.

If necessary, select **☰** > **SiriusXM SETTINGS** > **TUNESTART**.

When the TuneStart feature starts a song from the beginning, a progress bar appears and you can control the track using the same controls as Replay Mode (*Using Replay Mode, page 6*).

## Parental Controls

The parental control feature allows you to limit access to any SiriusXM channels, including those with mature content. When the parental control feature is enabled, you must enter a passcode to tune to the locked channels. You can also change the 4-digit passcode.

### Unlocking the Parental Controls

You can unlock the parental controls to access locked channels.

- 1 With the **SiriusXM** source selected, select **☰** > **PARENTAL**.
- 2 Select the **UNLOCK** check box.
- 3 Enter the passcode.

**TIP:** The default passcode is 0000.

The parental controls remain unlocked until you turn off the vehicle or until you lock them again.

### Locking Channels

- 1 With the **SiriusXM** source selected, select **☰** > **PARENTAL**.
- 2 Select the **UNLOCK** check box.

## SiriusXM Troubleshooting

Advisory	Description	Resolutions
Check Antenna	The radio has detected a fault with the SiriusXM antenna. The antenna cable may be disconnected or damaged.	<ul style="list-style-type: none"> <li>• Verify the antenna cable is connected to the SiriusXM Connect Vehicle Tuner.</li> <li>• Inspect the antenna cable for damage and kinks. Replace the antenna if the cable is damaged. SiriusXM products are available at your local car audio retailer, or at <a href="http://www.shop.siriusxm.com">www.shop.siriusxm.com</a>.</li> </ul>
Check Tuner	The stereo is having difficulty communicating with the SiriusXM Connect Vehicle Tuner. The tuner may be disconnected or damaged.	Verify the SiriusXM Connect Vehicle Tuner cable is connected securely to the stereo.
No Signal	The SiriusXM Connect Vehicle Tuner is having difficulty receiving the SiriusXM satellite signal.	<ul style="list-style-type: none"> <li>• Verify the SiriusXM antenna is outdoors with a clear view of the sky.</li> <li>• Verify the SiriusXM antenna is mounted securely.</li> <li>• Remove obstructions above or next to the SiriusXM antenna.</li> <li>• Inspect the cable antenna for damage and kinks. Replace the antenna if the cable is damaged. SiriusXM products are available at your local car audio retailer or at <a href="http://www.shop.siriusxm.com">www.shop.siriusxm.com</a>.</li> <li>• Consult the SiriusXM Connect Vehicle Tuner installation instructions for more information on antenna installation.</li> </ul>
Subscription Updated	The radio has detected a change in your SiriusXM subscription status.	<ul style="list-style-type: none"> <li>• Select any button to clear the message.</li> <li>• Go to <a href="http://www.siriusxm.com">www.siriusxm.com</a> or call 866-635-2349 with questions about your subscription.</li> </ul>
Channel Not Available	The channel you requested is not a valid SiriusXM channel, or the channel that you were listening to is no longer available. You may see this message briefly the first time you connect a new SiriusXM Connect Vehicle Tuner.	Go to <a href="http://www.siriusxm.com">www.siriusxm.com</a> for more information about the SiriusXM channel lineup.
Channel Not Subscribed	The channel you requested is not included in your SiriusXM subscription package, or the channel you were listening to is no longer included in your SiriusXM subscription package.	Go to <a href="http://www.siriusxm.com">www.siriusxm.com</a> or call 866-635-2349 for more information about your subscription package or to subscribe to the channel.
Channel Locked	The channel you requested is locked by the parental control feature.	Refer to the parental control section in the owner's manual to unlock channels.

### Clearing SiriusXM Data

You can clear all entered SiriusXM user information, such as favorite teams and alerts.

Use the **FACTORY RESET** option in the settings menu to reset the stereo (*Update Options, page 13*).

**NOTE:** The factory reset setting resets all data in the stereo, including AM and FM presets, zone settings, etc. in addition to clearing all SiriusXM user information.

- 3 Enter the passcode.

**TIP:** The default passcode is 0000.

- 4 Select **LOCK/UNLOCK**.

A list of available channels appears.

- 5 Select one or more channels to lock, and select **◀**.

- 6 Clear the **UNLOCK** check box to lock the parental controls.

You cannot access the locked channels while the parental controls are locked. You must unlock the parental controls to tune the locked channels.

### Clearing All Locked Channels

- 1 With the **SiriusXM** source selected, select **☰** > **PARENTAL** > **UNLOCK**.
- 2 Enter the passcode.
- 3 Select **☰** > **PARENTAL** > **CLEAR ALL LOCKED**.

### Changing the Parental Control Passcode



- 1 With the **SiriusXM** source selected, select **☰** > **PARENTAL** > **UNLOCK**.
- 2 Enter the passcode.
- 3 Select **☰** > **PARENTAL** > **CHANGE PIN**.
- 4 Follow the on-screen instructions.

### Connecting an Apple Device Using AirPlay

- 1 From the settings menu on your Apple device, connect to the same wireless network as your compatible Fusion stereo.

**NOTE:** You can connect some Apple devices to the network using a wired Ethernet connection, if applicable. Go to the Apple website for more information.

- 2 On your Apple device, open the music app you want to stream to the stereo.

- From the music app or program, select  or , and select the name of the stereo.
- If necessary, start playing music on the app.

The stereo changes to the AirPlay source automatically and plays audio from your Apple device.



**NOTE:** If your Apple device is using AirPlay 2 software, you can connect to multiple stereos on the same network.

**NOTE:** You cannot stream the AirPlay source to other stereos on the network using the Fusion PartyBus network (*Fusion PartyBus Networking*, page 9). Using AirPlay 2 software, you can play content on multiple stereos on the network, but the stereos must not be grouped.

**NOTE:** On some AirPlay devices, adjusting the volume on the device affects the volume level on the stereo.

### Setting an AirPlay Password

You can set a password that a user must enter when connecting to the stereo using the AirPlay feature.

- Select  >  > **AirPlay PASSWORD**.
- Enter a password.

**NOTE:** The AirPlay password is case-sensitive.

When connecting to this stereo using the AirPlay feature, the user must enter the password on their Apple device.



## DAB Playback

When you connect a compatible Digital Audio Broadcasting (DAB) module and antenna, such as the MS-DAB100A to the Apollo RA770 stereo, you can tune in to and play DAB stations.

DAB broadcasts are not available in all regions. When the stereo is not set to a compatible region, the DAB source is not available.

### Setting the Tuner Region

You must select the region you are in to receive DAB stations properly.

- Select  >  > **TUNER REGION**.
- Select the region you are in.

### Scanning for DAB Stations



Before you can scan for DAB stations, you must connect a compatible DAB module and antenna (not included) to the stereo. Because DAB signals are broadcast in select countries only, you must also set the tuner region to a location where DAB signals are broadcast.

- Select the **DAB** source.
- Select  to scan for available DAB stations.

When scanning is complete, the first available station in the first ensemble found begins playing.

**NOTE:** After the first scan is complete, you can select  again to re-scan for DAB stations. When the re-scan is complete, the system starts playing the first station in the ensemble you were listening to when you started the re-scan.

### Changing DAB Stations

- Select the **DAB** source.
- If necessary, select  to scan for local DAB stations.
- Select  or  to change the station.

When you reach the end of the current ensemble, the stereo automatically changes to the first available station in the next ensemble.

**TIP:** You can hold  or  to change the ensemble.

### Selecting a DAB Station from a List



- Select the **DAB** source.

- If necessary, select  to scan for local DAB stations.

- Select  > **BROWSE** > **STATIONS**.

- Select a station from the list.

### Selecting a DAB Station from a Category

- Select the **DAB** source.
- If necessary, select  to scan for local DAB stations.
- Select  > **BROWSE** > **CATEGORIES**.
- Select a category from the list.
- Select a station from the list.

## Presets

You can save your favorite AM stations and FM stations as presets for easy access.

You can save your favorite SiriusXM channels if you are connected to an optional SiriusXM tuner and antenna.

You can save your favorite DAB stations if you are connected to an optional DAB module and antenna.



### Saving a Station as a Preset

- With an applicable source selected, tune the stereo to a station or a channel.
- Press and hold .

### Selecting a Preset from a List

- With an applicable source selected, press and hold the dial.
- Select a preset.

### Removing Presets

- With an applicable source selected, press and hold the dial.
- Select .
- Select each preset you want to remove.
- When you are finished removing presets, select .

## Fusion PartyBus Networking

The Fusion PartyBus networking feature allows you to connect multiple compatible stereos together on a network, using a combination of wired or wireless connections.

You can group a compatible stereo, such as the Apollo RA770 stereo, with other compatible stereos connected to the network. Grouped stereos can share available sources and control media playback on all of the stereos in the group, which allows for a synchronized audio experience across the vessel. You can quickly create, edit, and break up groups as needed from any compatible stereo or remote control on the network.

You can use compatible stereos and remote controls, whether they are grouped or not, to adjust the volume of the available speaker zones for any stereo on the network.

You should refer to the installation instructions provided with your stereo when constructing the Fusion PartyBus network.

You can connect up to eight Fusion PartyBus stereos on a network wirelessly.

### Creating a Group

Before you can create a group, you must connect multiple compatible stereos to the Fusion PartyBus network. See the installation instructions provided with your stereo for information about installing and configuring the network.

- Press the dial to open the **CONTROL** screen.
- Turn the dial and select **EDIT GROUP** under the name of the stereo you want to be the primary stereo in the group.

3 Select the stereos you want to add to the group.

4 Select **GROUP**.

When the stereo is in a group, you can control the volume of all zones in a group at once from the **CONTROL** screen. From the source screen, you can select the source of any stereo in the group, except the Apollo SRX400 stereo and any sources that are not enabled on the Fusion PartyBus network (*General Settings, page 10*).

## Editing a Group

1 Press the dial to open the **CONTROL** screen.

2 Turn the dial, and select **EDIT GROUP**.

3 Select the devices you want to add to or remove from the group.

4 Select **GROUP** or **UNGROUP**.

## Leaving a Group

You can leave the Fusion PartyBus group to play local sources on the stereo.

1 Press the dial to open the **CONTROL** screen.

2 Turn the dial, and select **EDIT GROUP** under the name of the group that you want to leave.

3 Select the devices you want to remove from the group.

4 Select **UNGROUP**.

## Network Source Considerations

When selecting sources to play over the network, you should observe these considerations.

- A zone stereo, such as the Apollo SRX400, can create or join a group to control and play sources from other stereos, but it cannot share its sources with the group.
- You cannot share an AirPlay source with grouped stereos. Using AirPlay 2 software, you can play content on multiple stereos on the network, but the stereos must not be grouped (*Apple AirPlay, page 5*).
- You can disable sharing on most sources by changing the **PARTYBUS ENABLED** setting for the source. When disabled, the source cannot be selected from a grouped stereo (*General Settings, page 10*).
- When audio sources are shared over a data network, there is a slight delay in the synchronized audio that may be noticeable if you are also using an external audio source.
  - If you have a television with an Optical Out connection to the stereo and you continue to use the television speakers, there will be a delay between the audio from the television speakers and the optical audio synchronized on the grouped stereos.
  - If you synchronize a radio station and tune that same radio station on a non-networked stereo, there will be a delay between the audio from the non-networked stereo and the audio from the radio station synchronized on the grouped stereos.
  - You can remove this delay by changing the **PARTYBUS ENABLED** setting for the source, but the source cannot be shared with grouped stereos.

## General Settings

**NOTE:** When the stereo is in a group, not all settings and options are available.

Select  > .

**NOTE:** When a check box is filled, the option is on. When the check box is clear, the option is off.

**ZONE:** Enables you to configure the speaker zones (*Speaker Zone Settings, page 10*).

**BRIGHTNESS:** Adjusts the screen and dial backlight brightness (*Adjusting the Backlight and Dial Brightness, page 2*).

**TUNER REGION:** Sets the region used by the FM, AM, DAB, and SiriusXM sources.

**LANGUAGE:** Sets the language on the device.

**DEVICE NAME:** Sets a name for this stereo.

**TELEMUTE:** Sets the behavior of the mute function when the device is connected to a hands-free mobile phone. When a call is received, the device can either mute the audio or broadcast the call through the Aux1 input. See your hands-free kit instructions.

**SEARCHING:** Enables Fusion Alpha Search Technology (FAST), which allows you to quickly search for tracks by letter or number. You can select a number to enable the FAST menu if your music device contains more than the selected number of items.

**AirPlay PASSWORD:** Sets a password that a user must enter when connecting to the stereo using the AirPlay feature (*Setting an AirPlay Password, page 5*).

**POWER OPTIONS:** Adjusts power settings, such as the power-save mode (*Power Options, page 11*).

**SOURCE:** Allows you to enable sources, enable the Fusion PartyBus network for some sources, and name the sources. You may want to disable streaming for some sources, such as Optical, because streaming over the Fusion PartyBus network introduces a small audio lag that is not desirable in some situations.

**NETWORK:** Enables you to configure the Fusion PartyBus network settings (*Network Settings, page 11*).

**UPDATE:** Updates the stereo or connected devices (*Update Options, page 13*).

**ABOUT:** Shows the software version information for the stereo.

## Speaker Zone Settings

### Disabling the Internal Amplifiers

If you do not connect speakers directly to zones 1 and 2, you can disable the internal amplifiers to reduce power consumption.

1 Select  >  > **ZONE**.

2 Select **INTERNAL AMP ON** to clear the check box.

### Disabling a Zone

You can disable an unused zone and remove it from the audio level pages. When a zone is disabled, you cannot change any of the settings for that zone. You cannot disable zone 1.

1 Select  >  > **ZONE**.

2 Select a zone.

3 Select **ZONE ENABLED** to clear the check box.

### Enabling Volume Control of Zone 3 or 4 from a Connected Amplifier

By default the volume of zones 3 and 4 are controlled by the stereo. You can control the volume of these zones using the connected amplifier instead.

1 Select  >  > **ZONE**.

2 Select zone 3 or zone 4.

3 Select **VOLUME CONTROL** to clear the check box.

The audio signal from the zone is provided to the amplifier as a fixed-line-level output at maximum volume.

### Linking Zones

You can link zones 1 and 2 to keep the volume levels synchronized. Adjusting the volume of either of the linked zones affects both zones.

1 Select  > .

2 Select **ZONE** > **ZONE 2** > **LINK TO ZONE 1**.

**NOTE:** After zones 1 and 2 are linked, you cannot adjust the volume of each zone individually.

### Disabling the Loud Setting for a Zone

The LOUD setting maintains frequency response at low volumes and increases perceived loudness at high volumes. This setting is enabled by default in all zones.

1 Select  >  > **ZONE**.

2 Select a zone.

3 Select **LOUD** to clear the check box.

### Adjusting the Tone

1 Select  > .

2 Select **ZONE**.

3 Select the zone to adjust.

4 Select **TONE**.

5 Press the dial to select to a tone.

6 Turn the dial to adjust the level.

You can drag the slider bar to adjust the level of the tone.

### Setting a Zone Name

You can set a name for a speaker zone to make it easier to identify.

1 Select  >  > **ZONE**.

2 Select a zone.

3 Select **ZONE NAME**.

4 Use the on-screen keyboard to enter a name, and select .

### Adjusting the Subwoofer Filter

You can use the subwoofer filter setting to control the subwoofer cutoff frequency for each zone, which can enhance the blend of the sound produced by the speakers and the subwoofer. Audio signals above the selected frequency are not passed to the subwoofer.

**NOTE:** If a DSP setting has been applied to zone, this setting cannot be changed on the stereo. You can view the DSP setting for the optimal cutoff frequency as calculated by the DSP controller, but cannot adjust it.

1 Select  >  > **ZONE**.

2 Select a zone.

3 Select **SUB. FREQ.**

4 Select a frequency.

### Adjusting Additional Audio Settings for a Zone

1 Select  > .

2 Select **ZONE**.

3 Select a zone.

4 Select **MORE**.

5 Select one or more options:

- To limit the maximum volume output of this zone, select **VOLUME LIMIT**, and adjust the level.
- To set the subwoofer level for this zone, select **SUB LEVEL**, and adjust the level.
- To adjust the right and left speaker balance of this zone, select **BALANCE**, and adjust the balance.

### Power Options

Select  >  > **POWER OPTIONS**.

**POWER SAVE:** Disables the LCD backlight after one minute of inactivity to save battery power.

**STANDBY MODE:** Enables a standby mode instead of turning off the device completely and allows the device to be turned on from a device on the network ([Enabling Standby Mode, page 2](#)). When enabled, the device turns on much faster, but the device uses more battery when in standby mode than when turned off without standby mode enabled. When enabled, the device turns on much faster when you turn on the ignition or press .

**GESTURE SCREEN:** Enables the screen that hides the playback controls to show track info and album art only when playing media ([Gesture Screen, page 1](#)).

**NRX POWER:** Turns on or off the power the stereo provides to optional NRX series wired remote controls not on a NMEA 2000® network ([Configuring an Optional Wired NRX Remote Control, page 14](#)).

**SYSTEM OFF:** Sends a signal to turn off on all devices connected to the network.

## Network Settings

**TIP:** You can select the network status icon from any screen to open the network configuration menu.

Select  >  > **NETWORK**.

**WI-FI OFF:** Turns off all Wi-Fi® wireless functions.

**WI-FI CLIENT:** Configures the stereo as the wireless client, allowing it to wirelessly connect to other devices.

**WI-FI ACCESS POINT:** Configures the stereo as the wireless access point ([Setting the Fusion PartyBus Device as a Wireless Access Point, page 12](#)).

**ADVANCED:** Allows you to set the advanced wireless and wired settings, such as DHCP and SSID.

**RESET:** Resets all network settings for this stereo to the factory default values.

**DHCP CLIENT:** Sets the device as a DHCP client. This is the default setting for all devices that are not configured to be a DHCP server or wireless access point.

**STATIC IP:** Allows you to set a static IP address for the device ([Setting a Static IP Address, page 13](#)).

**GARMIN MARINE NETWORK:** Allows the device to be used on a Garmin® Marine Network so it can be viewed and controlled by connected Garmin chartplotters ([Configuring the Stereo for use with a Garmin Marine Network, page 13](#)).

**DETAILS:** Shows information about the network configuration.

### Connecting the Fusion PartyBus Device to a Wireless Access Point

You can connect this device to a wireless access point on a router or compatible Fusion PartyBus device on the network. This device can connect using Wi-Fi Protected Setup (WPS), if it is supported by your access point ([Connecting the Device to a Wireless Access Point Using Wi-Fi Protected Setup, page 12](#)). This device can connect using Apple Accessory Configuration (WAC) using a supported Apple device ([Connecting the Device to a Wireless Access Point Using Apple Wireless Accessory Configuration, page 12](#)).

1 Select  >  > **NETWORK** > **WI-FI CLIENT** > **SSID**.

A list of wireless access points within range appears.

2 Select the Fusion PartyBus wireless access point.

3 If necessary, select **PASSWORD**, enter the password, and select .

4 Select **SAVE**.

**NOTE:** When you connect the stereo to a wireless access point, you cannot use the wired network connection.

### Connecting the Device to a Wireless Access Point Using Wi-Fi Protected Setup

If it is supported by your wireless access point, you can connect this device using Wi-Fi Protected Setup (WPS) instead of manually selecting the SSID and entering the password.

**NOTE:** You may need to see the owner's manual for your wireless access point for information about enabling WPS.



- 1 Select  >  > **NETWORK** > **WI-FI CLIENT** > **WPS**.
- 2 Enable the WPS connection on your wireless access point.

**NOTE:** When you connect the stereo to a wireless access point, you cannot use the wired network connection.

### Connecting the Device to a Wireless Access Point Using Apple Wireless Accessory Configuration

If it is supported by Apple device, you can connect this device using Wireless Accessory Configuration (WAC) instead of manually selecting the SSID and entering the password.

**NOTE:** You may need to see the owner's manual for your Apple device for information about using WAC.



- 1 Select  >  > **NETWORK** > **WI-FI CLIENT** > **WAC**.
- 2 Use your compatible Apple device to complete the connection.

**NOTE:** When you connect the stereo to a wireless access point, you cannot use the wired network connection.

### Setting the Fusion PartyBus Device as a Wireless Access Point

Before you can connect additional Fusion PartyBus devices or smartphones to a Fusion PartyBus device wirelessly, you must configure one device as a wireless access point. This is not necessary if you installed a wireless router or other wireless access point on the network.

**NOTE:** You should not configure this device as a wireless access point if you have a router installed on the network. Doing so may introduce DHCP conflicts and result in poor network performance.

- 1 Select  >  > **NETWORK** > **WI-FI ACCESS POINT**.
- 2 Select an option:
  - To use factory-assigned default access point settings, select **USE DEFAULTS** and wait for the device to save the network settings.

**NOTE:** After the default settings are saved, you can scroll down to the bottom of the **NETWORK** menu to view the SSID and password assigned to the access point.
  - To customize the access point name and security settings, select **ADVANCED**, and proceed to the next step.
- 3 Select **SSID**, and change the default SSID, or name, for the wireless access point.
- 4 Select **AP SECURITY**, and change the security type for the access point.

**NOTE:** It is strongly recommended that you use WPA2 PERSONAL AP SECURITY setting. It is the most widely-used and secure wireless security protocol.
- 5 Select **PASSWORD**, and change the default password for the access point.
- 6 If necessary, select **COUNTRY**, and select your region.
- 7 Select **CHANNEL**, and select a channel range for the access point (optional).
- 8 Select **SAVE**.

You can adjust the wireless access point configuration at any time ([Wireless Access Point Settings, page 12](#)).

**NOTE:** When you configure the stereo as a wireless access point, you can also use the wired network connection without changing any additional settings. The wired and wireless networks are bridged.

### Wireless Access Point Settings

Select  >  > **NETWORK** > **ADVANCED** > **WI-FI ACCESS POINT**.

**NOTE:** You must configure the device to be a wireless access point before you can change the settings ([Setting the Fusion PartyBus Device as a Wireless Access Point, page 12](#)).

**SSID:** Sets the SSID, or name, for the network.

**AP SECURITY:** Sets the type of wireless security protocol used by the access point.

**NOTE:** It is strongly recommended that you set the AP SECURITY using WPA2 PERSONAL. It is the most widely-used and secure wireless security protocol.

**PASSWORD:** Sets the password for the access point. This is not available when the AP SECURITY setting is set to NONE.

**COUNTRY:** Sets the region where the stereo is located. Different regions may use different channels on the wireless spectrum, so you should set this to best accommodate local wireless devices.

**CHANNEL:** Sets the access point to use a group of channels in the high, low, or middle range of the available spectrum for your region. You may experience better performance if you set the channel in a range with fewer broadcasting access points.

**DHCP SERVER:** Sets the device to act as a wireless access point and the DHCP server on the network ([DHCP Settings, page 13](#)).

**WPS:** Initiates a Wi-Fi Protected Setup (WPS) connection. Devices with a WPS button or setting can connect to the access point on this stereo when the WPS connection is active.

**NOTE:** It can take up to two minutes to successfully connect to the access point after you select WPS.

### Advanced Network Configuration

You can perform advanced networking tasks on a Fusion PartyBus device, such as defining DHCP ranges and setting static IP addresses.

#### Setting the Fusion PartyBus Device as the DHCP Server

If you connected more than two network devices together using a network switch or wireless access point but you did not install a router, you should configure only one Fusion PartyBus stereo to be a DHCP server.

#### NOTICE

Having more than one DHCP server on the network causes instability and poor performance for all devices on the network.

**NOTE:** If you have set up this stereo as a WI-FI ACCESS POINT, it is configured as a DHCP server by default, and no further settings changes are needed ([Setting the Fusion PartyBus Device as a Wireless Access Point, page 12](#)).

**NOTE:** Although the Fusion PartyBus devices can communicate with each other without a DHCP server on the network, the devices take longer to connect to each other when you first turn them on. It is highly recommended to have one properly-configured DHCP server on the network for the best results.

- 1 If the device is connected to the network using an Ethernet cable, select  >  > **NETWORK** > **WI-FI OFF**.

You must turn off Wi-Fi before you can set the stereo as a wired DHCP server.

- 2 If the device is connected to the network using an Ethernet cable, select **STATIC IP** > **SAVE**.

You must set the stereo to use a static IP address before you can set it as a wired DHCP server.

- 3 Select **ADVANCED** > **DHCP SERVER** > **DHCP ENABLED** > **SAVE**.



You can configure the IP address range of the DHCP server ([DHCP Settings, page 13](#)).

### DHCP Settings

Select **≡** > **⚙** > **NETWORK** > **ADVANCED** > **DHCP SERVER**.

**DHCP ENABLED:** Sets the device as the DHCP server on the network.

**START IP:** Sets the first IP address in the IP-address range of the DHCP server.

**END IP:** Sets the final IP address in the IP-address range of the DHCP server.

### Configuring the Stereo for use with a Garmin Marine Network

You can connect this stereo to a Garmin Marine Network in order to view and control the stereo using a compatible Garmin chartplotter.

**NOTE:** When you configure the stereo for use with a Garmin Marine Network, you are limited to using only Garmin and Fusion devices. You cannot use third-party routers, phones, storage devices, or other network products with this stereo.

You cannot use Wi-Fi networking on a stereo configured for use with a Garmin Marine Network. This functionality is compatible with wired network connections only.

Select **≡** > **⚙** > **NETWORK** > **WI-FI OFF** > **GARMIN MARINE NETWORK**.

### Setting a Static IP Address

If the stereo is configured as a DHCP server, it is automatically assigned the IP address of 192.168.0.1. You can change this IP address.

If the stereo is a client on the network and you do not want the DHCP server to automatically assign an IP address to the stereo, you can set a static IP address.

**NOTE:** Every device on the network must have a unique IP address. If you select a static IP address that is the same as the IP address on the network, the devices will not work properly.

1 Select **≡** > **⚙** > **NETWORK** > **ADVANCED**.

2 Select an option:

- If the stereo is connected using an Ethernet cable, select **ETHERNET IP** > **STATIC IP**.
- If the stereo is set as a wireless access point or wireless client, select **WI-FI IP**.

3 Select an option:

- To set the IP address, select **IP**, and enter the IP address.
- To set the subnet mask, select **MASK**, and enter the subnet mask.

**NOTE:** The subnet mask must match all other devices on the network to work properly. A typical subnet mask is 255.255.255.0.

- To set the default gateway IP address, select **GATEWAY**, and enter the gateway IP address.

**NOTE:** The default gateway is typically set as the IP address of the DHCP server on the network.

4 Select **SAVE**.

### Resetting Network Settings

You can reset all network settings for this stereo to the factory default values.

Select **≡** > **⚙** > **NETWORK** > **RESET** > **YES**.

### Update Options

Select **≡** > **⚙** > **UPDATE**.

## NOTICE

Do not turn off the device or disconnect the power during a software update. Turning off the power during a software update may cause the device to become unresponsive.

### NOTE:

- You should update the device software using a USB flash drive.
- If the stereo is connected to a wireless network, you can update the software using the Fusion-Link app on a mobile device.
- The device may restart a few times when updating. This is normal.
- You can program only newer versions of software on the device.

**STEREO:** Updates the stereo.

**NRX REMOTE:** Updates an optional NRX remote connected to the NMEA 2000 port or NMEA 2000 network using a valid software update file on a connected USB flash drive.

**ERX REMOTE:** Updates an optional remote connected to the ETHERNET port or the Fusion PartyBus network using a valid software update file on a connected USB flash drive.

**DAB MODULE:** Updates an optional DAB module connected to the SIRIUS XM port using a valid software update file on a connected USB flash drive.

**FACTORY RESET:** Restores all settings to the factory default values.

**REFRESH NETWORK:** Clears discovered stereos from the device and searches for new stereos on the network.

## Additional Stereo Control Options

### Connecting to a Garmin Watch

For a list of a compatible Garmin watches, go to [www.fusionentertainment.com](http://www.fusionentertainment.com).

For more information about the watch, see the watch manual at [www.garmin.com/manuals](http://www.garmin.com/manuals).

1 Following the instructions in the watch manual, install the Fusion-Link Lite™ app from the Connect IQ™ store onto the watch.

2 On the stereo, select the **BT** source.

3 Select **≡** > **DISCOVERABLE**.

The stereo remains discoverable for two minutes.

4 Bring the watch within 3 m (10 ft.) of the stereo.

**NOTE:** Stay 10 m (33 ft.) away from other ANT® devices while pairing.

5 Open the Fusion-Link Lite app on the watch.

The first time you open the app on the watch, the watch automatically pairs with and connects to the stereo. If you need to pair to another stereo, in the Fusion-Link Lite app, select **Settings** > **Pair new**.

6 Control the audio playback using the Fusion-Link Lite app on the watch.

After the devices are paired, they connect automatically when they are turned on, within range, and the app is open on the watch.

### Connecting to an ARX70 Remote Control

1 On the stereo, select the **BT** source.

2 Select **≡** > **DISCOVERABLE**.

3 Bring the ARX70 remote control within 10 m (33 ft.) of the stereo.

**NOTE:** Stay 10 m (33 ft.) away from other ANT devices while pairing.

- 4 On the ARX70 remote control, press and hold  until the status LED starts alternating green and red.

The remote control searches for the stereo. When the remote control pairs successfully, the status LED turns on green briefly and then turns off.

If the remote control cannot find the stereo, the status LED turns on red briefly and then turns off.

## Fusion-Link Wireless Remote Control App

You can use the Fusion-Link remote control app on your compatible Apple or Android device to adjust the stereo volume, change the source, control playback, select and manage radio presets, and adjust some stereo settings. You can use the app to set up and configure DSP profiles on the stereo. You can use the app to update the stereo software.

The app communicates with the stereo using a wireless connection to the mobile device. You must connect your compatible device to the stereo using Bluetooth or Wi-Fi technology to use the app.

If the stereo is connected to a network with a Wi-Fi access point, the app can communicate with the stereo using the network for greater range than a Bluetooth connection.

**NOTE:** You cannot update the stereo software using a Bluetooth connection. You must connect the app using a Wi-Fi connection to update the stereo software wirelessly.

You can connect an Apple device to the stereo using a USB cable to update the stereo software.

For information about the Fusion-Link remote control app for compatible Apple or Android devices, go to the Apple App Store<sup>SM</sup> or the Google Play<sup>TM</sup> store.

## FUSION-Link™ Network Technology

FUSION-Link network technology allows you to fully control compatible Fusion entertainment systems on compatible multi-function displays installed at the helm, flybridge, or navigation station of the vessel. This provides integrated entertainment control and a less cluttered console.

The partnered multi-function display becomes the portal on which you can control all audio on the vessel, no matter where on the vessel the connected stereo is installed. The FUSION-Link equipped stereo can be installed out of sight if space is an issue and users need to access the stereo only to replace removable media.

FUSION-Link technology on this device can communicate using existing industry-standard network connections including Ethernet and Wi-Fi wireless technology.

FUSION-Link technology offered on this device can communicate using existing industry-standard NMEA 2000 networks.

For a list of FUSION-Link capable products from companies partnered with Fusion, go to [www.fusionentertainment.com](http://www.fusionentertainment.com).

## NMEA 2000 Remote Control and Display

The stereo can be controlled by compatible Fusion wired remote controls installed in the audio zones throughout the vessel. Operating the entertainment system from the remote control is similar to operating it from the main stereo.

Fusion wired remote controls operate over an existing NMEA 2000 network, so wiring the remote controls directly to the stereo is not necessary. All remote controls connected to the same NMEA 2000 network as the stereo can control the stereo.

If your vessel does not have a NMEA 2000 network, you can directly connect a single Fusion remote control or create a Fusion remote control network to connect multiple Fusion wired

remote controls directly to the NMEA 2000 connector on the stereo. See the installation instructions provided with your stereo and remote for more information.



The Fusion wired remote control can also serve as an NMEA<sup>®</sup> display showing NMEA navigation data or vessel performance data from other NMEA devices on an existing NMEA 2000 network. See the instructions provided with your remote control for information on supported NMEA 2000 PGN information.

## Configuring an Optional Wired NRX Remote Control

### NOTICE

The stereo is configured by default to work with a NMEA 2000 network, and the NRX POWER option should be enabled only when an optional wired NRX remote control is connected directly to the stereo. Enabling this option when the stereo is connected to a NMEA 2000 network may damage other devices on the NMEA 2000 network.

If you connect an optional wired NRX remote control directly to the stereo, and not through a NMEA 2000 network, additional configuration is needed.

- 1 Select  >  > **POWER OPTIONS**.
- 2 Select an option:
  - If you connected both your stereo and your optional wired remote to a NMEA 2000 network, make sure the **NRX POWER** option is not selected. This enables the optional remote to receive power from the NMEA 2000 network.
  - If you connected the optional wired remote directly to the stereo through the NMEA 2000 connector, select the **NRX POWER** option. This enables the stereo to supply power to the optional remote.

## NMEA 2000 Information

NMEA 2000 is the most popular marine standard for data communication within vessels. It has become the standard for sending navigation and engine management data within vessels. Fusion introduces an industry-first product by incorporating NMEA 2000 functionality in its audio remote control devices. This enables the user to monitor a series of NMEA sentences available over the NMEA 2000 network on a connected remote control.

Go to [www.fusionentertainment.com](http://www.fusionentertainment.com) for a full list of supported NMEA sentences.

## Appendix

### Cleaning the Device

- 1 Dampen a soft, clean, lint-free cloth with fresh water.
- 2 Gently wipe the device.

### Software Updates

For best results, you should update the software in all Fusion devices at the time of installation to ensure compatibility.

You can update the software using the Fusion-Link remote control app on your compatible Apple or Android device, or using a USB flash drive.

To download the app and update the device software, go to the Apple App Store or the Google Play store. For software updates and instructions on updating the device using the USB flash drive, go to the device product page at [fusionentertainment.com/manuals/ms-ra770](http://fusionentertainment.com/manuals/ms-ra770).

### Updating the Software Using a USB Flash Drive



You can update the device software using a USB flash drive.

## NOTICE

Do not turn off the device or disconnect the power during a software update. Turning off the power during a software update may cause the device to become unresponsive.

### NOTE:

- The device may restart a few times when updating. This is normal.
- You can program only newer versions of software on the device.

- 1 Go to [fusionentertainment.com/manuals/ms-ra770](http://fusionentertainment.com/manuals/ms-ra770), and select **Software Updates > Download**
- 2 Extract contents of the .zip file to the root of your USB storage device.  
The contents of the software update are contained in a folder named Garmin.
- 3 Insert the USB storage device in the USB port of the stereo.
- 4 Select  >  > **UPDATE > STEREO**.

### Updating the Software Using the Fusion Link App

You must connect the Fusion-Link app to the network using a wireless router or wireless access point to update the software. You cannot update the software using a Bluetooth connection.



**NOTE:** If the stereo you want to update is in a group, remove it from the group ([Leaving a Group](#), page 10).

If the Fusion PartyBus network has a wireless router or wireless access point, you can update the stereo software using the Fusion-Link app, available for compatible Apple or Android on the Apple App Store or the Google Play store.

## NOTICE

Do not turn off the device or disconnect the power during a software update. Turning off the power during a software update may cause the device to become unresponsive.

### NOTE:

- The device may restart a few times when updating. This is normal.
  - You can program only newer versions of software on the device.
- 1 Connect your mobile device to a wireless router or wireless access point on the Fusion PartyBus network.
  - 2 Open the Fusion-Link app, and verify that you can see the stereo in the app.
  - 3 If the Fusion PartyBus is not connected to the internet, disconnect the mobile device from the wireless router or access point.
  - 4 In the Fusion-Link app, select  > **CHECK FOR UPDATES**. Select the stereo. Download
  - 5 Select the stereo.
  - 6 Select **Download**.  
The app downloads the software update file.
  - 7 If the Fusion PartyBus is not connected to the internet, after the app finishes downloading the update file, reconnect the mobile device to the wireless router or access point on the Fusion PartyBus network.
  - 8 In the Fusion-Link app, reconnect to the stereo.
  - 9 Select  > **GENERAL > Software Updates > Online Software Update**.  
The app transfers the software update to the stereo over the Wi-Finetwork, the stereo updates the software, and then restarts.

## Registering Your Apollo RA770

Help us better support you by completing our online registration today.

- Go to [www.fusionentertainment.com](http://www.fusionentertainment.com).
- Keep the original sales receipt, or a photocopy, in a safe place.

## Troubleshooting

### The stereo does not respond to key presses

- Hold  until the stereo turns off, and turn it on again to reset the stereo.
- Disconnect power to the stereo for two minutes to reset the stereo.

### My Bluetooth audio is interrupted by short breaks

- Ensure the media player is not covered or obstructed.  
Bluetooth technology performs best with line-of-sight operation.
- Bring the media player within 10 m (33 ft.) of the stereo.
- Turn off the **DISCOVERABLE** setting after pairing a Bluetooth device to the stereo.

### The stereo does not display all song information from my Bluetooth source

The availability of song information such as song title, artist name, track duration, and album cover artwork depends on the capability of the media player and music application.





### Network Troubleshooting

If you cannot see or connect to Fusion PartyBus devices on the network, check the following:

- Verify that only one device, either a stereo or a router, is configured as a DHCP server.
- Verify that all Fusion PartyBus devices, network switches, routers, and wireless access points are connected to the network and turned on.
- Verify that wireless Fusion PartyBus devices are connected to a wireless router or wireless access point on the network.  
**NOTE:** Wired connections are more reliable than wireless connections. If possible, you should connect devices to the network using an Ethernet cable.
- You may experience wireless interference if there are many nearby wireless access points. Change the channel on your router or wireless access point to test for and correct interference.
- Connecting a Bluetooth device to a stereo configured as a wireless access point or client may reduce wireless performance. Disconnect Bluetooth devices to test for and correct interference.
- If you configured static IP addresses, verify that every device has a unique IP address, that the first three sets of numbers in the IP addresses match, and that the subnet masks on every device are identical.
- If you have made configuration changes that might be causing networking issues, reset all network settings to the factory default values.

### Network Status Icons

A network-status icon is shown on some screens of the stereo. You can refer to this table to understand the appearance of the icon and help diagnose issues with the Fusion PartyBus network.

	The stereo is configured for a wired network connection and connected to a wired network using an Ethernet cable.
	The stereo is configured for a wired network connection, but cannot detect the wired network. An Ethernet cable may not be connected or there may be other problems with the network.
	The stereo is in Wi-Fi accessory configuration (WAC) mode, which allows for an easy connection to Apple devices.
	The stereo is configured as a wireless access point.

	The stereo is configured as a wireless client and connected to a wireless access point. The number of bars indicates the signal strength.
	The stereo is configured as a wireless client, but is not connected to a wireless access point. There may be a problem with the connection settings or with the wireless access point.

Output power per channel <sup>1</sup>	4 x 43 W RMS at 14.4 Vdc input, 2 ohm, 10% THD 4 x 26 W RMS at 14.4 Vdc input, 4 ohm, 10% THD
Line output level (max.)	5.5 V (peak to peak)
Aux input level (typical)	1 V RMS

### The stereo keeps locking up when connected to an Apple device

- Press and hold the power button to reset the stereo.
- Reset the Apple device. Go to [www.apple.com](http://www.apple.com) for more information.
- Make sure you have the latest version of iTunes® and the latest operating software on your Apple device.

### The stereo is not finding my connected Apple device

- Make sure your Apple device supports Interface Accessory Protocol 2 (iAP2). This stereo is not compatible with iAP1 devices.
- Make sure you have the latest version of iTunes and the latest operating software on your Apple device.
- Make sure you have the latest version of the Fusion-Link application on your Apple device.
- Reset the Apple device.  
Go to [www.apple.com](http://www.apple.com) for more information.
- Contact your Fusion dealer or send an email to Fusion from [www.fusionentertainment.com](http://www.fusionentertainment.com).

### My Apple AirPlay audio is interrupted by short breaks

- Make sure the Apple device is not covered or obstructed.
- Make sure the Apple device has a good connection to the same Wi-Fi network as the stereo.
- Make sure the Apple device is not connected to the stereo using Bluetooth technology and Wi-Fi.  
Using both a Bluetooth and a Wi-Fi connection may cause playback interruptions.

## Specifications

### General

Weight	750 g (26.5 oz.)
Water resistance	IEC 60529 IPX7 (front of stereo only, when properly installed)
Operating temperature range	From 0 to 50°C (from 32 to 122°F)
Storage temperature range	From -20 to 70°C (from -4 to 158°F)
Input voltage	From 10.8 to 16 Vdc
Current (max.)	15 A
Current (muted)	Less than 900 mA
Current (off, standby mode enabled)	110 mA
Current (off, standby mode disabled)	80 mA
Fuse	15 A mini blade-type
NMEA 2000 LEN @ 9 Vdc	1 (50 mA)
Bluetooth wireless range	Up to 10 m (30 ft.)
ANT wireless range	Up to 3 m (10 ft.)
Wireless frequencies/protocols	Wi-Fi 2.4 GHz @ +15 dBm nominal Bluetooth 2.4 GHz @ +10 dBm nominal ANT 2.4 GHz @ +4 dBm nominal
Compass-safe distance	15 cm (5.9 in.)

### On-board, Class D Amplifier

Output music power per channel	4 x 70 W max. 2 ohm
Total output peak power	280 W max.

### Tuner frequencies

Tuner	Europe and Australasia	USA	Japan
FM radio frequency range	87.5 to 108 MHz	87.5 to 107.9 MHz	76 to 95 MHz
FM frequency step	50 kHz	200 kHz	50 kHz
AM radio frequency range	522 to 1620 kHz	530 to 1710 kHz	522 to 1620 kHz
AM frequency step	9 kHz	10 kHz	9 kHz

## Stereo Dimension Drawings

### Side Dimensions

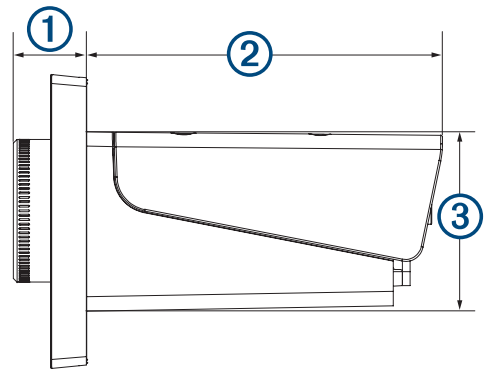

①	20.4 mm (0.8 in.)
②	99 mm (3.9 in.)
③	50 mm (1.97 in.)

### Top Dimensions

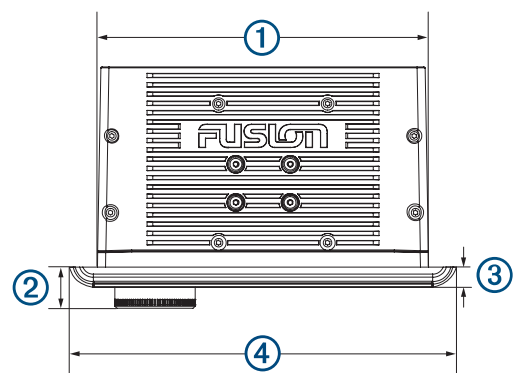

①	164 mm (6.5 in.)
②	20.4 mm (0.8 in.)
③	10 mm (0.39 in.)
④	192 mm (7.56 in.)

<sup>1</sup> The stereo may limit the output power to prevent the amplifier from overheating, and to maintain the audio dynamics.

# Index

## A

AirPlay **5, 8, 9**  
alerts **6, 7**  
AM **5, 9**  
amplifier **10**  
Android **5**  
Android device **4, 5**  
Android devices **4, 14**  
ANT devices **13**  
Apple device **4, 5, 16**  
Apple devices **4, 12, 14**  
auxiliary input **3, 6**

## B

backlight **2**  
bass **11**  
Bluetooth devices **3, 4, 14**  
brightness **2**

## D

DAB **5, 9**  
device  
    cleaning **14**  
    keys **1**  
    registration **15**  
digital audio **6**  
DSP **3**

## F

factory settings **13**  
FM **5, 9**  
Fusion PartyBus network **11, 12**  
FUSION-Link **14**

## G

gain **3**  
Garmin Marine Network **13**  
groups **2, 10**  
    creating **9**  
    editing **10**

## H

home zone **2**

## I

icons **2, 15**

## K

keys **1**

## L

language **10**

## M

media player **1, 4**  
music player **1**  
mute **3**

## N

name **2**  
network **2, 5, 6, 9, 10, 12, 13, 15**  
network configuration **13**  
NMEA 2000 **14**

## O

optical audio **6**

## P

PartyBus **12, 13**  
power key **1**  
presets **9**  
product registration **15**

## R

radio  
    AM **5**  
    FM **5**  
    SiriusXM **6–8**  
registering the device **15**  
remote control **14**

resetting **8, 10**

## S

settings **2, 3, 10, 11, 13**  
SiriusXM **5, 9**  
    parental controls **8**  
    Satellite Radio **6, 8**  
software, updates **14, 15**  
source **1, 2, 5, 8, 10**  
speaker zones **2, 3, 10, 11**  
    home **2**  
standby **2**  
subwoofer **3, 11**

## T

tone **11**  
treble **11**  
troubleshooting **15**

## U

USB **4, 5**  
    flash drive **4, 5**  
USB devices **3, 4**

## V

volume **3, 10**  
    adjusting **2**

## W

watch **13**  
Wi-Fi technology **11, 12**  
wireless devices, network configuration **12**

## Z

zones **2**

## FUSION SUPPORT

New Zealand	09 369 2900
Australia	1300 736 012
Europe	+44 (0) 370 850 1244
USA	623 580 9000
Pacific	+64 9 369 2900



**FUSION**<sup>®</sup>  
FUSIONENTERTAINMENT.COM