

INFPRV450 Owner's Manual



Prospec Electronics
Sound Systems For The Outdoor Enthusiast



This stereo should not be washed with a pressure washer neither should it be washed with chemicals. A wet sponge or damp cloth will suffice.

This product is serviced exclusively by Prospec Electronics Inc. and must be returned to Prospec for in and out of warranty repairs. It can not be serviced under warranty by other Infinity service centers.

For service contact us :
3325 South Morgans Point Road Mt Pleasant SC 29466

Tel 843-849-9037

Or visit: www.prospecelectronics.com



Prospec Electronics
Sound Systems For The Outdoor Enthusiast

3325 South Morgans Point Rd. | Mt. Pleasant, SC 29466

P: 843-849-9037 | www.prospecelectronics.com













Table of Contents

Table of Contents -----	1
Product Description -----	2
Installation Instructions -----	3
Wiring Configuration -----	4
General Function of Buttons -----	5
Sign up Display & Home Menu -----	6
General Operations -----	7
General Settings -----	7
Radio Section Operation -----	10
SiriusXM® Section Operation -----	12
Bluetooth Section Operation -----	16
USB Section Operation -----	18
iPod/iPhone Operation -----	20
AUX Section Operation -----	21
Troubleshooting -----	22

Product Description

This Infinity PRV450 incorporates a 3.5" TFT color screen, ready to complement your day whether you are on the water, motorcycle, UTV trail, or farm. Following the same footprint as the popular INFPRV250, this stereo is synonymous with excellence. ~~In fact, the INFPRV450 was listed as one of the top new products of 2016 by Boating Industry magazine. Check in with us often to see what the next Prospec experience will bring!~~

The INFPRV450 incorporates the following features:

-  AM/FM
-  SiriusXM-Ready™ (SiriusXM connect tuner and subscription required)
-  Bluetooth Audio Streaming with ID tagging
-  USB input and control-for USB drives only
-  Auxiliary input
-  3.5" color TFT screen / Waterproof faceplate
-  50W x 4 amplifier
-  Wired remote option
-  U.S. and European tuning
-  Charging through USB
-  3 pair of RCA output including subwoofer output
-  Can Bus Control via NMEA2000

The Infinity brand is part of Harman International Industries. In 1958, Harman Kardon developed the world's first stereo receiver and we are proud to bring you the world's first Infinity marine color screen receiver!

Sirius, XM and all related marks and logos are trademarks of Sirius XM Radio Inc. All rights reserved.

Troubleshooting

The following information helps you self-diagnose common issues without the need for contacting SiriusXM support.

Advisory Name	Recommended Description
Check Antenna	The radio has detected a fault with the SiriusXM antenna. The antenna cable may be either disconnected or damaged. Verify that the antenna cable is connected to the SiriusXM Connect Vehicle Tuner. Inspect the antenna cable for damage and kinks. Replace the antenna if the cable is damaged. SiriusXM products are available at your local car audio retailer or online at www.shop.siriusxm.com .
Check Tuner	The radio is having difficulty communicating with the SiriusXM Connect Vehicle Tuner. The tuner may be disconnected or damaged. Verify that the SiriusXM Connect Vehicle Tuner cable is securely connected to the radio.
No Signal	The SiriusXM Connect Vehicle Tuner is having difficulty receiving the SiriusXM satellite signal. Verify that your vehicle is outdoors with a clear view of the sky. Verify that the SiriusXM magnetic mount antenna is mounted on a metal surface on the outside of the vehicle. Move the SiriusXM antenna away from any obstructions. Inspect the antenna cable for damage and kinks. Consult the SiriusXM Connect Vehicle tuner installation manual for more information on antenna installation. Replace the antenna if the cable is damaged. SiriusXM products are available at your local car audio retailer or online at www.shop.siriusxm.com .
Subscription Updated	The radio has detected a change in your SiriusXM subscription status. Press ENTER button to clear the message. Visit www.siriusxm.com or call 866-635-2349 in the USA or 877-438-9677 in Canada if you have questions about your subscription.
Channel Not Available	The channel that you have requested is not a valid SiriusXM channel or the channel that you were listening to is no longer available. You may also see this message briefly when first connecting a new SiriusXM Connect Vehicle tuner. Visit www.siriusxm.com for more information about the SiriusXM channel line up.
Channel Not Subscribed	The channel that you have requested is not included in your SiriusXM subscription package or the channel that you were listening to is no longer included in your SiriusXM subscription package. In the U.S.A., visit www.siriusxm.com or call 1-866-635-2349 if you have questions about your subscription package or would like to subscribe to this channel. In Canada, visit www.siriusxm.ca or call 1-877-438-9677.
Channel Locked	The channel that you have requested is Locked by the radio Parental Control feature. See the description on Parental Control, page 14 for more information on the Parental Control feature and how to access locked channels.

Troubleshooting

*Note: In many respects, a stereo acts much like a computer and occasionally requires a reboot. In the unlikely event of product malfunction, a reset can usually fix the issue. For software reset operation, please refer to page 8.

Issue	Cause	Solution
No power	<ol style="list-style-type: none"> 1. Incorrect wiring 2. Fuse is blown 3. Low battery voltage 	<ol style="list-style-type: none"> 1. Double check wiring 2. Replace fuse 3. Check voltage of vehicle battery with multimeter. Voltage must be at least 11V.
No Sound	<ol style="list-style-type: none"> 1. Speaker connection came loose 2. Bad speaker 3. Output blown 4. Volume too low on media device 	<ol style="list-style-type: none"> 1. Double check connections. 2. Replace bad speaker with known good speaker and connect. 3. Send unit in for repair. 4. Increase volume of media device
No Reception	<ol style="list-style-type: none"> 1. Antenna not firmly seated in socket 	<ol style="list-style-type: none"> 1. Insert firmly
USB stick not reading	<ol style="list-style-type: none"> 1. File must be a mp3 or wma file 	<ol style="list-style-type: none"> 1. Convert format to mp3 or mwa.
While in Bluetooth mode:		
No Connection	<ol style="list-style-type: none"> 1. You are not connect to the "PRV" address on your portable media device. 2. Out of range 3. The connection is already in use. 	<ol style="list-style-type: none"> 1. Choose "PRV" 2. Bring portable media device closer to the receiver. Device needs to be within 30'. 3. Ask the person who first paired to drop out.

Installation

A mounting gasket has been added inside the package for convenience. Trace along the outside edge of the gasket thus revealing your cutout.

Mounting Illustration

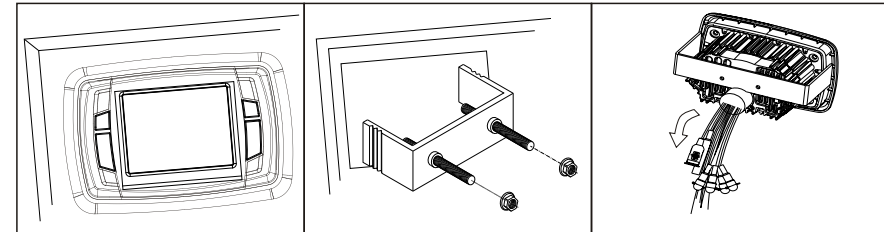

1. Avoid installing stereo below cupholders! Make sure mounting substrate is flat to avoid flexing of the plastic.
2. Use the back bracket and studs to affix the unit. Install the U bracket behind the unit, using two nuts per bolt for ultra hold.
3. To avoid possible water ingress into wire harness area, route the harness in the downward direction as shown above.

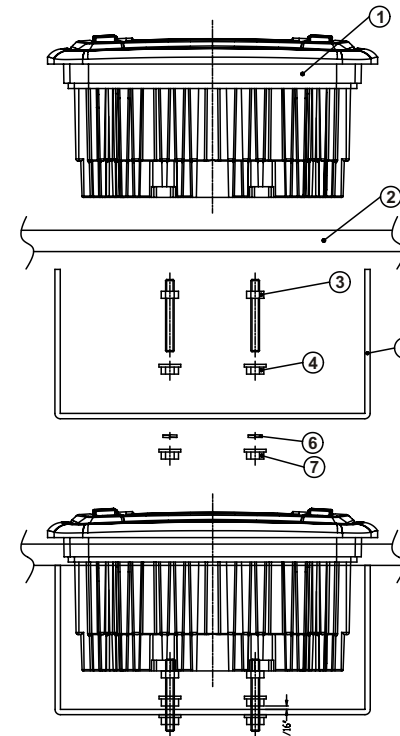

NO.	PART DESCRIPTION
1	RADIO
2	MOUNTING PLATE
3	MOUNTING STUDS
4	JAMB NUTS
5	MOUNTING BRACKET
6	SPRING WASHER
7	OUTER NUTS

Instructions:

1. Install jamb nuts (4) loosely on mounting studs (3), so they will not touch mounting brackets (5) when installed.
2. Slip mounting bracket (5) on and make flush with mounting surface (2). **DO NOT TIGHTEN**
3. Snug spring washer (6) and outer nuts (7) against mounting plate (2). **DO NOT TIGHTEN**
4. Position jamb nuts approximately 1/16" from mounting bracket.
5. Tighten outer nuts completely.

Wire Configuration

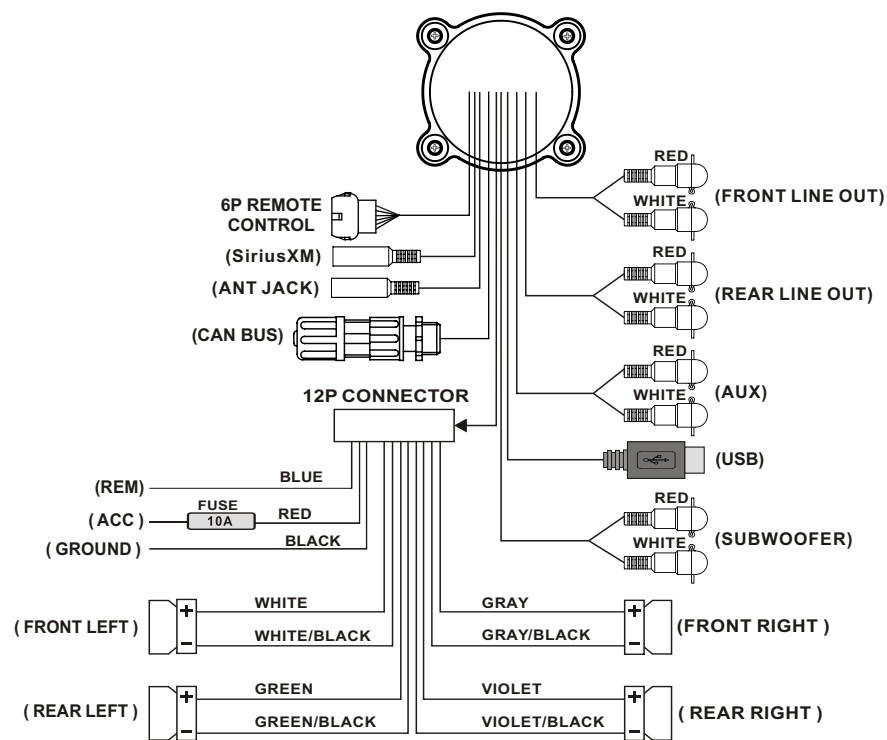

NOTE:

1. When wiring, the red lead is recommended to be wired to ACC/ignition power lead.
2. Make sure that the black wire on the wiring harness is connected to a good ground point on the boat. If the chassis of the boat is used as a ground point, make sure that the surface is scraped clean of paint before attaching the wire to it. It is recommended to connect the black ground wire directly to negative terminal (-) of the boat battery.
3. Before wiring your system, disconnect your boat battery's positive (+) cable. This helps prevent damage in case of a short.

AUX Section Operation

1. To Select USB mode

At Home Menu, press TUNE Up or Down to move the highlight to AUX source, then press ENTER button to go into the AUX mode.

Note: highlight movement indicated by the icon background change.



The use of auxiliary mode allows you to play the portable music device through the headphone jack.

Note: An additional accessory/adaptor must be purchased in order for this to happen. Prospec's part, SEAMINI2 or SEAUSBMINI36 fulfills this option.

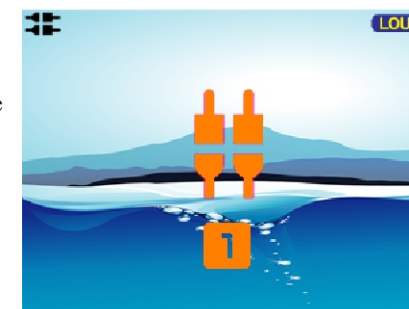

iPod/iPhone Operation

1. Connect

Connect an iPod/iPhone to the USB socket, it will read the files automatically. The track information displays on the screen once playback starts.

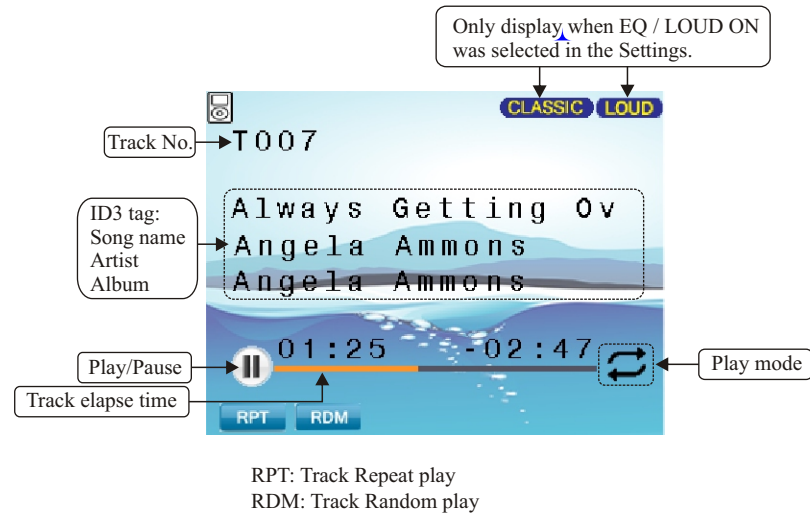

2. Play/Pause Play

While iPod/iPhone playing, simply press the PAUSE button to pause the playback, and press it again to resume playback.

Note: refers to PLAY; refers to PAUSE.

3. Track Up/Down

While iPod/iPhone playing, simply press TUNE Up or Down button to select the next or previous track.

3. Track Repeat play

While iPod/iPhone playing, simply press MENU button to activate navigation, it will highlight at RPT, then press MENU button to toggle select Track Repeat or RPT OFF. (Note: Refers to play current track repeatedly.)

4. Random play

While iPod/iPhone playing, simply press MENU button to activate navigation, then press TUNE Down button to move highlight to RDM, then press MENU button to toggle select Track Random or RDM OFF.

(Note: Refers to play all the tracks in a random sequence.)

Note: Please make sure the iPod/iPhone cable is connected correctly.
And it is recommended to use the original cable for connection.

General Function of Buttons

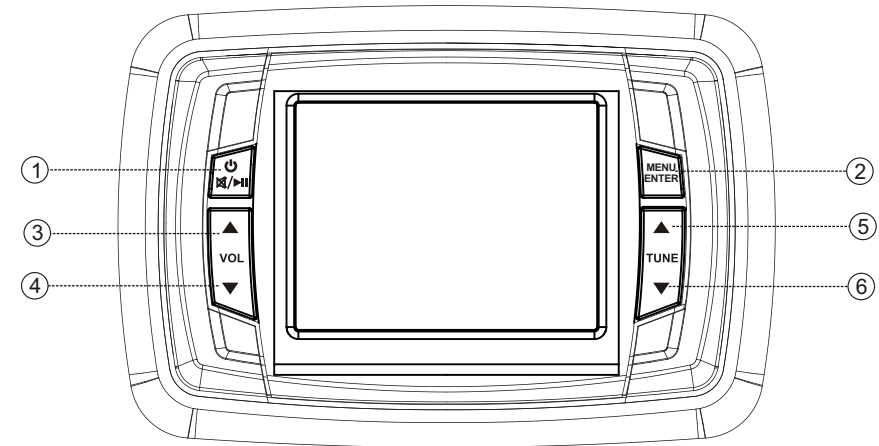

1. POWER, MUTE, PAUSE button

- With unit off, press to power the unit on.
- With the unit on, press and hold for over 2s to power the unit off.
- In Radio, SiriusXM, AUX mode, press to MUTE sound output, press again to resume sound output.
- In USB, BT Music mode, press to PAUSE playback, press again to resume playback.

2. MENU, ENTER button

- In any status, press and hold for 2s to navigate to home display.
- In source playing status, quick press to activate the bottom navigation function. (Note: Bottom navigation function is disabled after 5s without operation.)
- In any selection status, press ENTER to confirm selection.

3. VOLUME Up button

- Simply press it to increase volume level.

4. VOLUME Down button

- Simply press it to decrease volume level.

5. Tune Up button

- In playing status, press to select the next station, channel, or track.
- In bottom navigation mode, press to move highlight upward/over.

6. Tune Down button

- In playing status, press to select the previous station, channel, or track.
- In bottom navigation mode, press to move highlight downward/over.

Sign Up Display & Home Menu

1. Sign Up Display

Once the unit powered on, the introductory home screen appears for 4 seconds, then switches to the last played mode before power off occurred.



2. Home Menu (Source display)

At Home Menu, press the TUNE Up/Down button to move to desired source and press ENTER button to confirm.

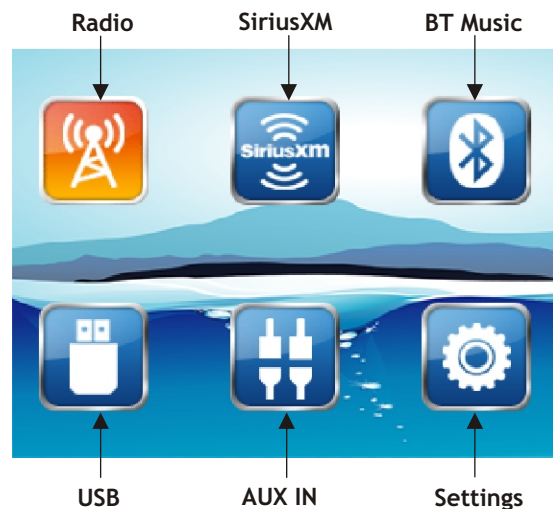

Note: icon background changes to two toned burnt orange when selected. For example, Radio mode is the selected mode in above picture.

USB Section Operation

4. Track Up/Down

While USB playing, simply press TUNE Up or Down button to select the next or previous track. To fast forward or rewind, press and hold TUNE button.

5. Scan Play

While USB playing, simply press MENU button to activate navigation, it will highlight at SCAN, now repeat press MENU button to toggle select Track Scan, Directory Scan, or SCAN OFF. (Note: The play mode icon would change simultaneously.)

SCN Refers to play the first 10s of all the tracks in the USB device.

D.SCN Refers to play the first 10s of all the tracks in current Directory.

Refers to play all the tracks in normal sequence.

6. Repeat play

While USB playing, simply press MENU button to activate navigation, then press TUNE Down button to move highlight to RPT, repeat press MENU button to toggle select Track Repeat, Directory Repeat, or RPT OFF. (Note: The play mode icon would change simultaneously.)

Refers to play current track repeatedly.

Refers to play the tracks in current Directory repeatedly.

Refers to play all the tracks in normal sequence.

7. Random play

While USB playing, simply press MENU button to activate navigation, then press TUNE Down button to move highlight to RDM, repeat press MENU button to toggle select Track Random, Directory Random, or RDM OFF. (Note: The play mode icon would change simultaneously.)

Refers to play all the tracks in a random sequence.

Refers to play the tracks in current Directory in a random sequence.

Refers to play all the tracks in normal sequence.

8. F.LIST (Folder / File Search)

While USB playing, simply press MENU button to activate navigation, then press TUNE Down button to move highlight to F.LIST, press ENTER button to go inside the F.List.

In F.List, press TUNE Up or Down button to choose desired Folder, press ENTER to display sub-directory or files inside, press TUNE Up or Down button to choose desired file and press ENTER button to play it.



USB Section Operation

1. To Select USB mode

At Home Menu, press TUNE button to move the highlight to USB source, then press ENTER button to go into the USB mode.

Note: This input is designed to read and play USB drives (mp3 and wam files), not media/phones.

You can charge most phones through the USB input. Music, however, needs to be played back by using either BT or Aux input.



2. USB Screen Description

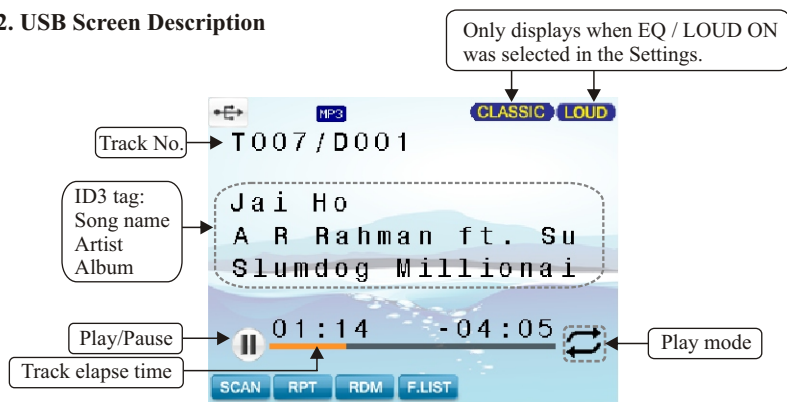

SCAN: Intro Scan play (Track / Directory Scan play)
 RPT: Repeat play (Track / Directory Repeat play)
 RDM: Random play (Track / Directory Random play)
 F.List: To display the Directory / File List

3. Play/Pause Play

While USB is playing, press the PAUSE button to pause the playback, and press again to resume playback.

Note: refers to PLAY; refers to PAUSE.

General Operations

1. VOLUME Control

In any mode, press VOL UP/DN button to adjust volume level.

Press and hold VOL button to adjust volume level rapidly.

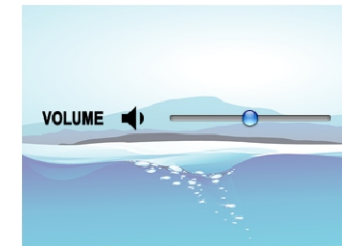

2. MUTE Control

In Radio, SiriusXM, or AUX mode, press MUTE button to mute sound output; press again to resume sound output.



3. General Settings

Press and hold MENU button to go back to Home Menu, then press TUNE UP/DN button to move highlight to Settings source. Then press ENTER button to go into the Settings mode.



3-1. Bass Control

In Settings screen, press TUNE Up or Down button to select Bass, then press VOL Up or Down button to adjust Bass level.

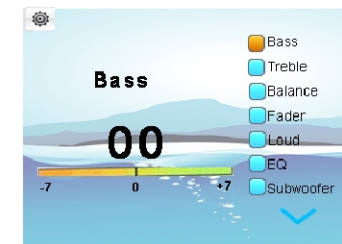

3-2. Treble Control

In Settings screen, press TUNE Up or Down button to select Treble, then press VOL Up or Down button to adjust Treble level.





General Settings

3-3. Balance Control

In Settings screen, press TUNE Up or Down button to select Balance, then press VOL Up or Down button to adjust Balance level.

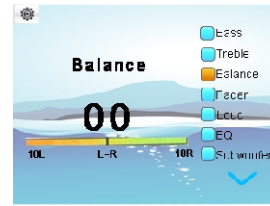

3-4. Fader Control

In Settings screen, press TUNE Up or Down button to select Fader, then press VOL Up or Down button to adjust Fader level.

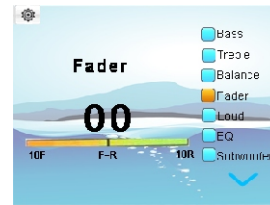

3-5. Loud Control

In Settings screen, press TUNE Up or Down button to select Loud, then press VOL Up or Down button to select ON or OFF.

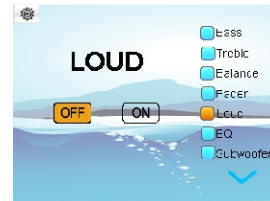

3-6. EQ Selection

In Settings screen, press TUNE Up or Down button to select EQ, then press VOL Up or Down button to select Off, Classics, Jazz, Pop or Rock.



3-7. Subwoofer Gain Control

At Setting screen, press TUNE Up or Down button to select Subwoofer, then press VOL Up or Down button to adjust Subwoofer Gain level.

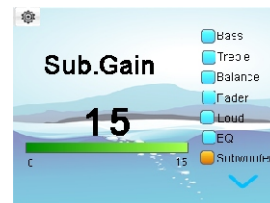

3-8. I-Volume Control

At Setting screen, press TUNE Up or Down button to select I-Volume, then press VOL Up or Down button to adjust the Initial Volume Level. This feature controls the maximum volume level desired when powered on.

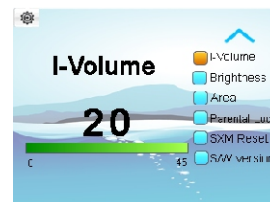

Bluetooth Section Operation

4. Play/Pause Play

Once the BT device being paired is successful, music will begin to play.

Note: For some Bluetooth enabled phones, you might activate play from your phone first. It depends on the phone itself.

While BT Music playing, press the PAUSE button to pause the playback, and press it again to resume playback.

Note:  refers to PLAY;  refers to PAUSE.

5. Track Up/Down

While BT Music is playing, press TUNE Up or Down button to select the next or previous track.

6. Disconnect

In BT Music playing mode, in order to disconnect the BT device, press MENU button to activate bottom navigation, it will highlight at DISCONN, press ENTER button to disconnect the BT connection.

Note: When your BT device battery is at low charge, the Bluetooth connection may occasionally be lost. To maintain good connectivity ensure that your BT device battery is adequately charged.

7. Connect

With BT device paired OK, but disconnected, if you want to reestablish the BT connection, press MENU button to activate bottom navigation, it will highlight at CONNE. Press ENTER button to connect the BT device.

Note: With the Bluetooth connection disconnected, once you power on the unit next time, it will establish the Bluetooth connection automatically.



Bluetooth Section Operation

1. To Select Bluetooth mode

At Home Menu, press TUNE button to move the highlight to Bluetooth source, then simply press ENTER button to go into the Bluetooth mode.

Note: highlight movement indicated by the icon background change.



2. Bluetooth Screen Description

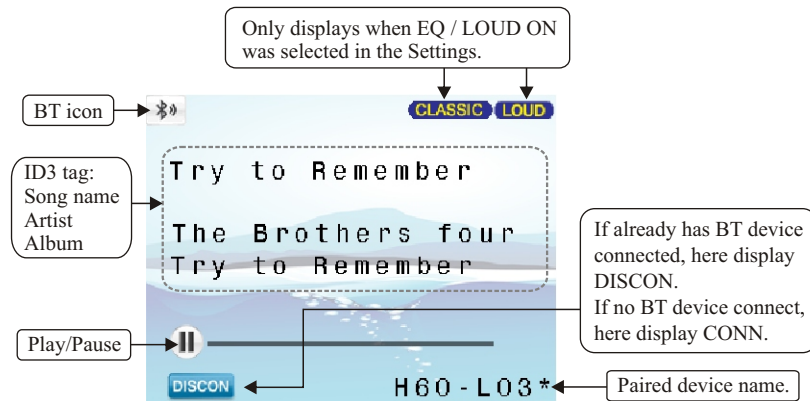

CONN: To establish Bluetooth connection.
DISCON: To disconnect the BT Device.

3. Pair BT Device

If there is no BT device paired, go to settings on the BT device and turn the Bluetooth option ON. Pick "PRV" option on your Bluetooth enabled device.

(if you are prompted for a password, the code entered will be "1234".)

If there was previously a BT device paired, simply press MENU button to highlight CONN and press ENTER to establish the BT connection.

General Settings

3-9. Brightness Adjustment

In Settings screen, press TUNE Up or Down button to select Brightness, then press VOL Up or Down button to adjust Brightness level.

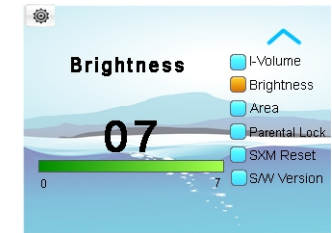

3-10. Area Selection

In Settings screen, press TUNE Up or Down button to select Area, then press VOL Up or Down button to select USA or EUR.

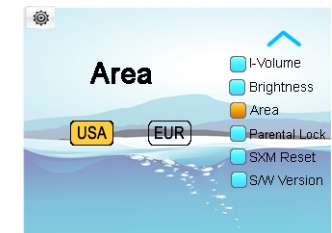

3-11. SiriusXM Parental Lock - Change Code

In Settings screen, press TUNE Up or Down button to select Parental Lock. Then press VOL Up or Down button to select Parental Lock sub-features. Please refer to SiriusXM Section Operation for details.



3-12. SXM Reset

At Setting screen, press TUNE Up or Down button to select SXM Reset, then ENTER button to reset the SXM Tuner.



3-13. Software Version View, Software Reset

At Setting screen, press TUNE Up or Down button to select S/W Version, then press MENU button to highlight at VIEW and press ENTER button to view the Software Version.



Software Reset:

In Software Version display status, press TUNE UP, TUNE DN, and TUNE UP in sequence, then press and hold TUNE DN for 7s to reset the unit.

Note: It will be necessary to re-enter the radio preset memories and other personal settings as these will have been erased when the software was reset. After resetting the unit, ensure all functions are operating correctly.

Radio Section Operation

1. To Select Radio mode

At Home Menu, press TUNE Up/Down button to move the highlight to Radio source, then press ENTER button to go into the Radio mode.

Note: highlight movement indicated by the icon background change to two tone orange.



2. Radio Screen Description

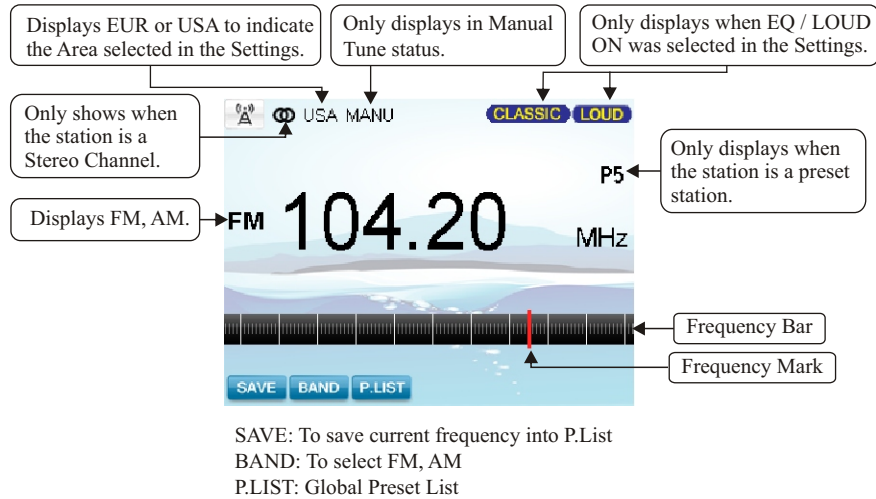

SiriusXM Section Operation

11. Channel Parental Lock

The Parental Control feature allows you to limit access to any SiriusXM channels, including those with mature content. When enabled, the Parental Control feature requires you to enter a passcode to tune to the locked channels.

To Lock / Unlock any Channel, first go back to Home Menu and select Settings. Press TUNE button to choose Parental Lock.

- Parental Lock On / Off

Press VOL UP/DN button to move highlight to Off, then press ENTER, it will prompt for passcode, input four digits with VOL button and after each input press ENTER button to jump to next input. After four digit input, it will indicate "Lock is ON".

With Parental Lock On selected, all the locked channels are temporarily unlocked which will let you listen to the locked channels without inputting the passcode again.

Note: Once you leave SiriusXM mode or power off the unit, it will revert to Parental Lock Off.

- To Unlock all channels

Press VOL UP/DN button to move highlight to ALL, then press ENTER, it will prompt for passcode, input four digits with VOL button and after each input press ENTER button to jump to next input. After four digit input, press ENTER button to unlock all channels.

- To Lock/Unlock channels one by one

Press VOL UP/DN button to move highlight to CH, then press ENTER, it will prompt for passcode, input four digit passcode, press ENTER button. It will display the Channel list, press TUNE UP/DN button and press MENU at the desired channel.

Note: if the selected channel was locked, then pressing MENU button will unlock it; and if the selected channel was unlocked, pressing MENU button will lock it.

12. SiriusXM Parental Lock Code Change

If you want to change your code, first go back to Home Menu and select Settings. Press TUNE UP button to choose Parental Lock. Press VOL button to choose CODE CHANGE. It will prompt for current passcode, then new code, and one more prompt for new code confirmation. Use VOL button for code input, and press ENTER button after each input. If a wrong digit is inputted, press TUNE DN button to move to previous digit input. Note: Factory default passcode was 0000.

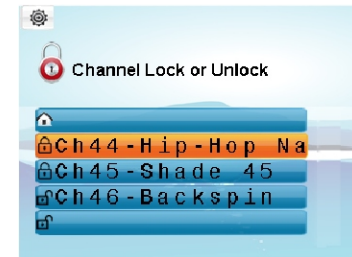
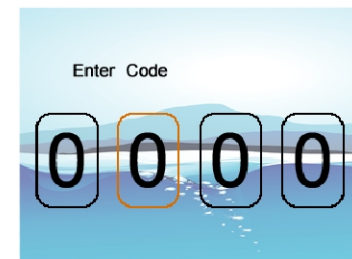



SiriusXM Section Operation

8. Direct Channel Input

In SiriusXM mode, first press MENU button to activate navigation, then press TUNE Down button to move highlight at DIRECT, and press ENTER button. It will display the keyboard. Press VOL Up or Down button to select the desired digit, then press ENTER after each selection to move to next input. After three digit input, simply press ENTER button again to jump to the selected Channel.



Note: If a wrong digit is inputted, simply press TUNE DN button to move to previous digit input. Repeat above operation until the correct channel is inputted.

9. Category List

In SiriusXM mode, first press MENU button to activate navigation, then press TUNE Down button to move highlight to Cat.LIST and to display the Category List. Press TUNE Up or Down button to select and press ENTER button at your desired Category. Then press TUNE Up or Down and ENTER button to select a desired channel.



10. Preset List Channel Tuning

In SiriusXM play mode, press MENU button to activate navigation, press TUNE UP/DN button to move highlight to P.List, then press ENTER button to display the Global Preset List.

Simply press TUNE Up or Down button to select a desired preset and press ENTER button to listen to it. It will let you listen to the selected channel for 10s before it reverts back to source playing screen. During this time, you can select another channel with TUNE UP/DN button.

01	CH 056	10	CH 025
02	90.10 MHz	11	107.90 MHz
03	98.10 MHz	12	87.50 MHz
04	106.10 MHz	13	603 kHz
05	CH 146	14	CH 008
06	87.50 MHz	15	CH 002
07	630 MHz	16	106.10 MHz
08	CH 015	17	107.90 MHz
09	1400 kHz	18	87.50 MHz



Radio Section Operation

3. AREA Selection

At Home Menu, move highlight to Settings, press ENTER button, then press TUNE Down button to move highlight to AREA feature, press VOL Up or Down button to select between USA and EUR.

4. BAND Selection

In Radio playing mode, press MENU button to activate navigation, then press TUNE Down button to move highlight to BAND. Now press MENU button to toggle and select between FM or AM band.

5. Auto Tuning

In Radio playing mode, press TUNE Up/Down button to activate auto tune. This results in automatically stopping at next station of sufficient signal strength.

6. Manual Tuning

In Radio playing mode, long press TUNE Up/Down button for 2s. This will activate manual tune with MANU display on the top area. Then repeatedly press TUNE Up/Down button to tune frequency by steps.

NOTE: Radio will revert back to AUTO tune mode after 5s without operation.

7. Station Save

In Radio play mode, manually or auto tune to a station, then press MENU button to activate bottom navigation. Select SAVE icon and press ENTER button. The unit will display the Global Preset List screen, press TUNE UP/DN button to select a preset No. and press ENTER button to save current station into Preset List. The Preset number will display once the station is saved. The unit will go back to previous display if no operation in 5s.

8. Preset List

In Radio play mode, press MENU button to activate navigation, press TUNE UP/DN button to move highlight to P.List, then press ENTER button to display the Global Preset List.

Press TUNE Up or Down button to select a preset and press ENTER button to listen to it. This will let you preview the selected station for 10s before it reverts back to Radio screen. During this time, you can select another station with TUNE UP/DN button.

01	CH 056	10	CH 025
02	90.10 MHz	11	107.90 MHz
03	98.10 MHz	12	87.50 MHz
04	106.10 MHz	13	603 kHz
05	CH 146	14	CH 008
06	87.50 MHz	15	CH 002
07	630 MHz	16	106.10 MHz
08	CH 015	17	107.90 MHz
09	1400 kHz	18	87.50 MHz

NOTE:

1. Receiver can store up to 18 stations.
2. If there is no operation at Global Preset List screen, it will go back to Radio screen by itself after 5s or simply long press MENU button for 2s to go back to previous display.



SiriusXM Section Operation

1. What is SiriusXM

Only SiriusXM® brings you more of what you love to listen to, all in one place. Get over 140 channels, including commercial-free music plus the best sports, news, talk, comedy and entertainment. Welcome to the world of satellite radio. A SiriusXM Vehicle Tuner and Subscription are required. For more information, visit www.siriusxm.com

Activating your SiriusXM Subscription

1. After installing your SiriusXM Connect Tuner and antenna, power on your radio and select SiriusXM mode. You should be able to hear the SiriusXM preview channel on Channel 1. If you cannot hear the preview channels, please check the installation instructions to make sure your SiriusXM Connect tuner is properly installed.

For more information on how to install the SiriusXM Connect Vehicle tuner, consult the installation guide included with the tuner.

2. After you can hear the Preview channel, tune to Channel 0 to find the Radio ID of your tuner. In addition, the Radio ID is located on the bottom of the SiriusXM Connect Vehicle Tuner and its packaging. You will need this number to activate your subscription. Write the number down for reference.

Note: the SiriusXM Radio ID does not include the letters I, O, S or F.

In the USA, you can activate online or by calling SiriusXM Listener care:

Visit www.siriusxm.com/activatenow

Call SiriusXM Listener Care at 1-866-635-2349

For Canadian Subscriptions, please contact:

Visit www.siriusxm.ca/activatexm

Call XM Customer Care at 1-877-438-9677

As part of the activation process, the SiriusXM satellites will send an activation message to your tuner. When your radio detects that the tuner has received the activation message, your radio will display: Subscription Updated, press Enter to continue. Once subscribed, you can tune to channels in your subscription plan. Note, the activation process usually takes 10 to 15 minutes, but may take up to an hour. Your radio will need to be powered on and receiving the SiriusXM signal to receive the activation message.

2. To Select SiriusXM Mode

At Home Menu, press TUNE button to move the highlight to SiriusXM source, then press ENTER button to go into the SiriusXM mode.

Note: highlight movement indicated by the icon background change.



SiriusXM Section Operation

3. SiriusXM Screen Description

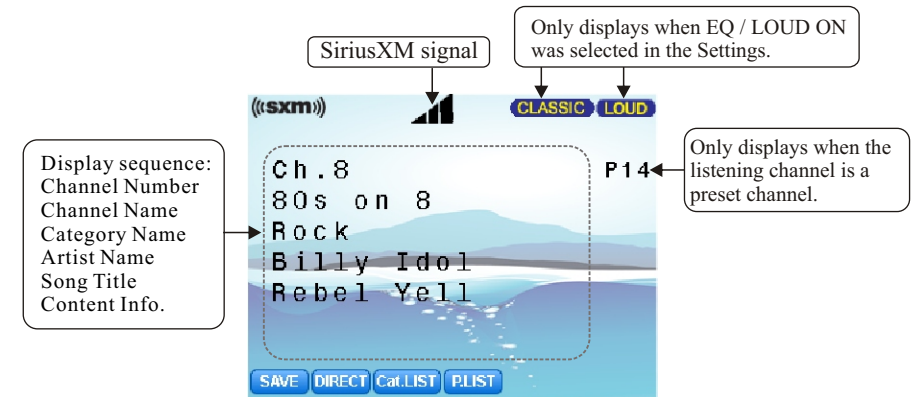

SAVE: To save current channel into P.List.

DIRECT: To directly input a channel No.

Cat.List: To display the Category List.

P.LIST: To display the Global Preset List.

4. To Display Radio ID

Tune to Channel 0 or direct Tune to Channel 0 to display the Radio ID.

5. MUTE

In SiriusXM mode, press the MUTE button to mute sound output, and press it again to resume sound output.

6. To Select the Previous / Next Channel

In SiriusXM mode, press TUNE Up or Down button to select the previous or next channel. Press and hold TUNE Up or Down button to rapid tune/browse channels, and release the button when the desired channel is displayed.

7. Storing a Channel as a Preset

In SiriusXM playing mode, tune to or direct tune to a channel which you want to store as a preset, then press MENU button to activate bottom navigation. It will highlight at SAVE, now press ENTER button. It will display the Global Preset List screen, press TUNE UP/DN button to select a preset number and press ENTER button to save current channel into Preset List. The Preset No. will display once the channel is saved. The unit will revert back to the previous display if no operation is performed in 5s.