

Avalon

The Art of the Pontoon



2022 GAUGES

USER GUIDE

3 & 5 INCH

LCD DISPLAY SCREEN

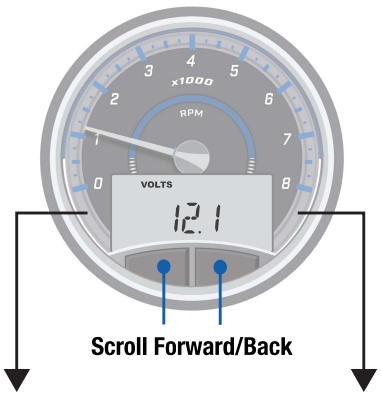
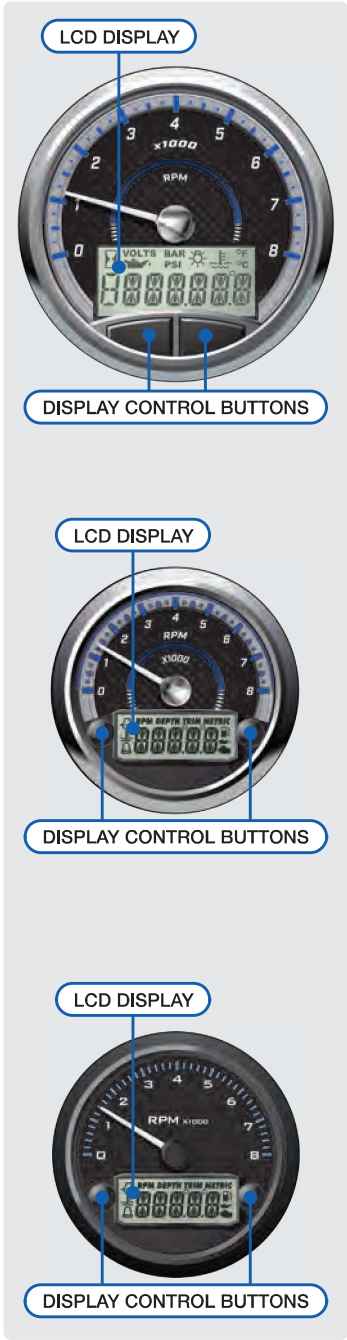

VOLTAGE



TRIM LEVEL



COOLANT TEMP



FUEL LEVEL



OIL PRESSURE



HEADING

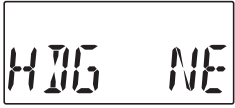

ENGINE HOURS



DEPTH LEVEL



SEA (LAKE) TEMP



SETTINGS MAIN MENU

Press + Hold
BOTH Buttons for
Settings Main Menu



Scroll
Forward/Back



Press +
Hold to Select

SYSTEM UNITS

UNITS



METRIC

CALIBRATION MENU

CAL

DIAGNOSTICS MENU

DIAG

ENGINE MENU

ENGINE

CONFIGURATION MENU

CONFIG

SOFTWARE VERSION

S/W VER



8000-

EXIT MENU

EXIT

Software Version Number
will flash and exit to
Settings Main Menu

Return to
Main Screen



Scroll
English
/Metric

Press +
Hold to
Select

CALIBRATION SETTINGS

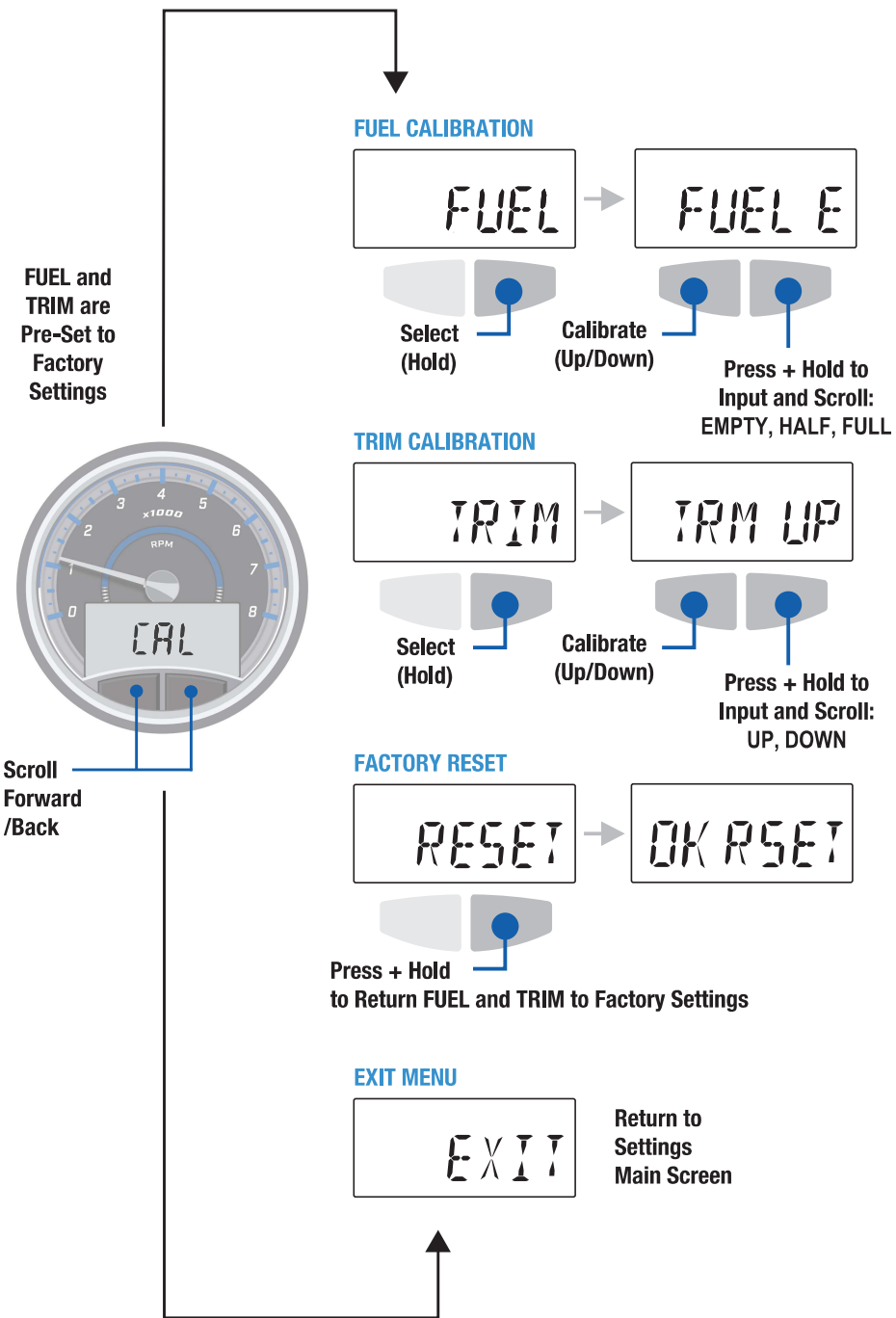

DIAGNOSTICS SETTINGS



Scroll Forward /Back

CONTINUED NEXT PAGE

VOLTAGE

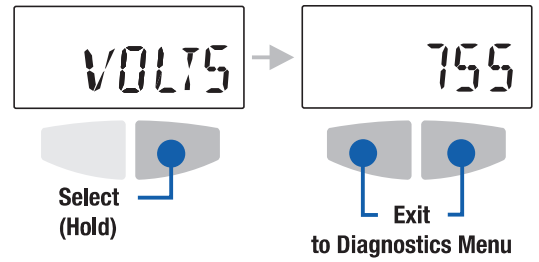

FUEL LEVEL

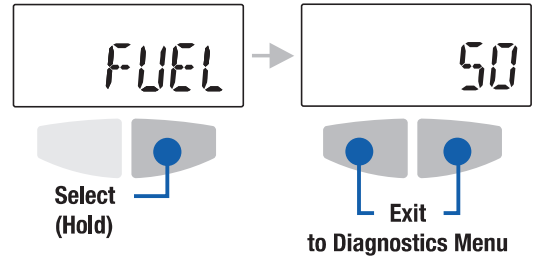

COOLANT TEMP (NOT AVAILABLE ON THIS MODEL)



TRIM LEVEL

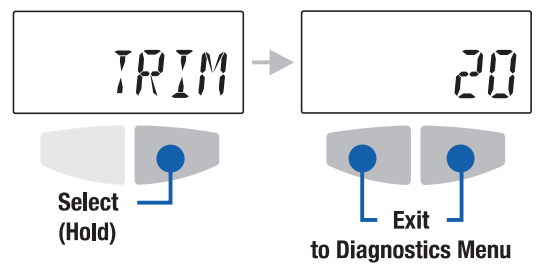

DIAGNOSTICS SETTINGS (CONTINUED)

CONTINUED
FROM PREVIOUS
PAGE



Scroll
Forward
/Back

TACH (ENGINE RPM'S)

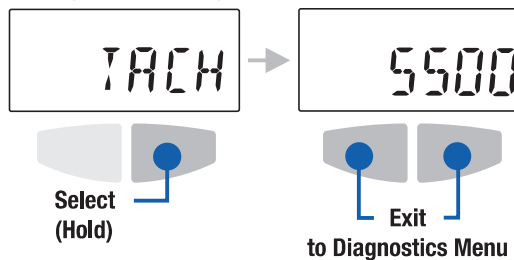

SPEED

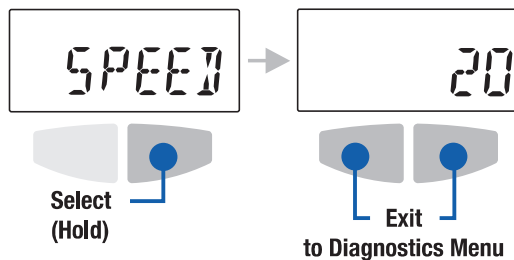

CAN NETWORK CONNECTION



Displays Active or
Inactive (NOCAN) message

EXIT MENU



Return to
Settings
Main Screen

ENGINE SETTINGS

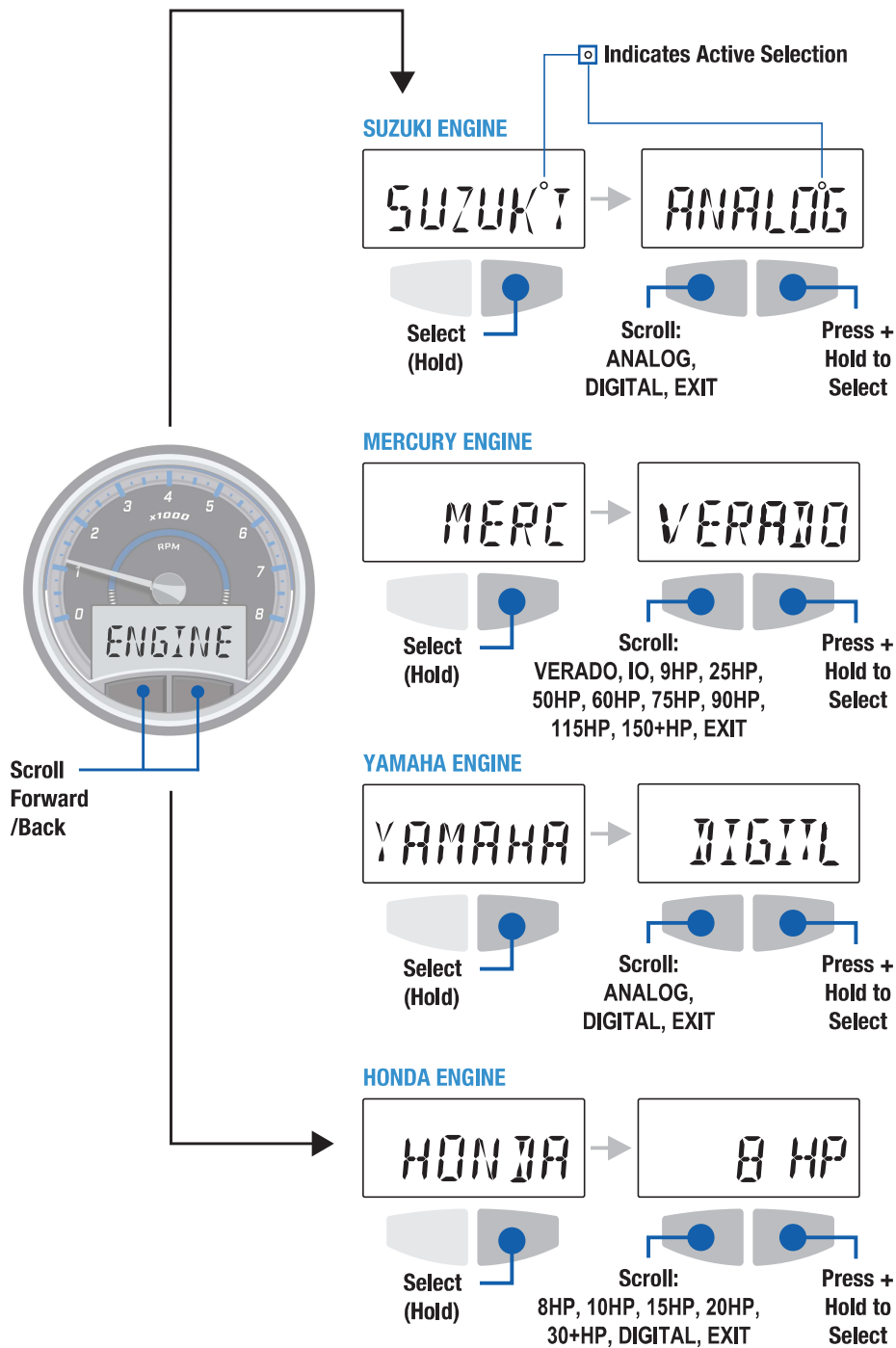

CONFIGURATION SETTINGS

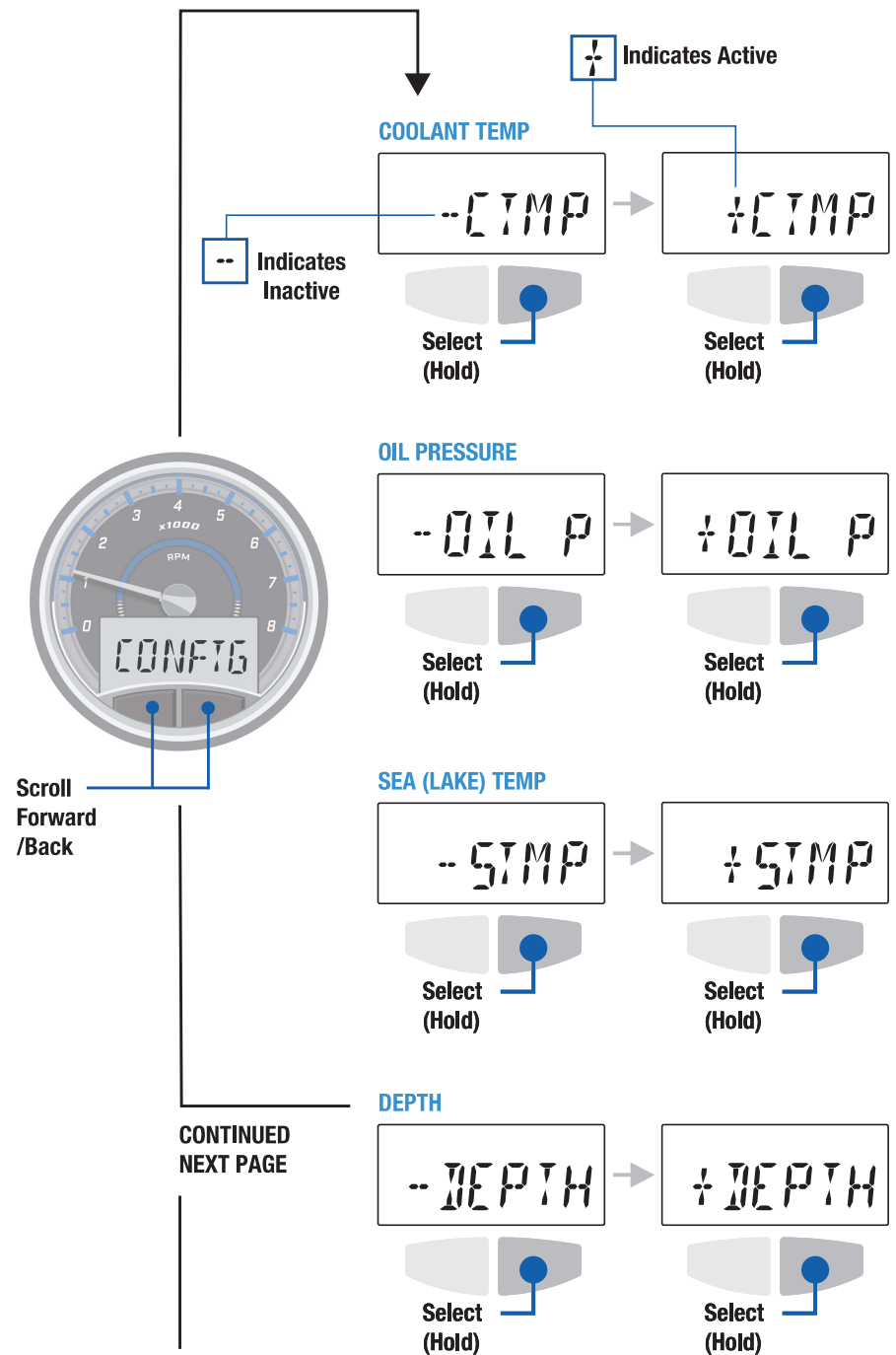

CONFIGURATION SETTINGS (CONTINUED)

CONTINUED
FROM PREVIOUS
PAGE



Scroll
Forward
/Back

HEADING

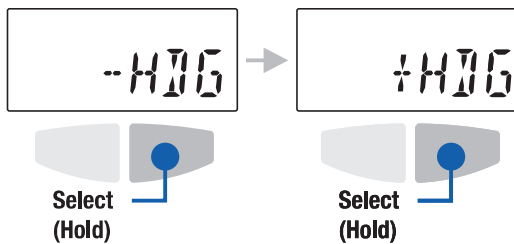

FUEL

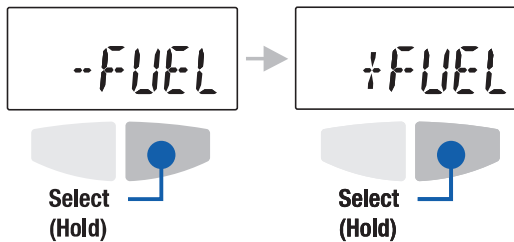

TRIM

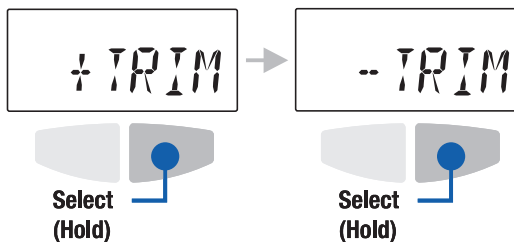

EXIT MENU



A vertical strip of dark blue water with ripples, set against a white background. The water is dark blue with subtle ripples and reflections, creating a textured appearance. The text 'DRAFT-02' is located at the bottom left of the strip.

DRAFT-02