

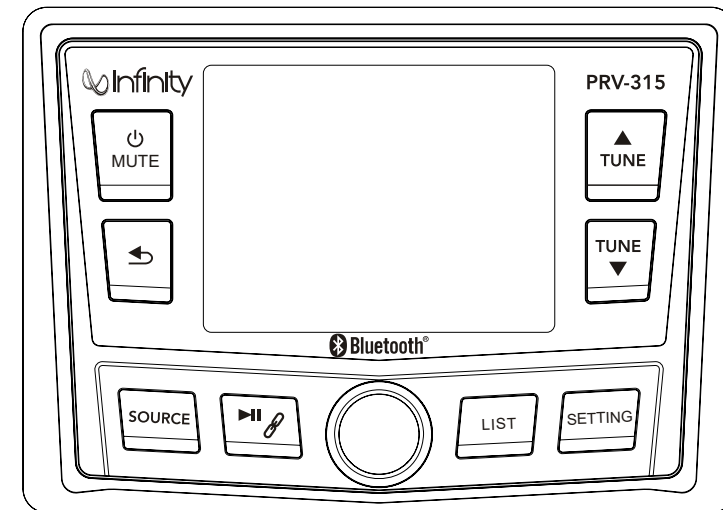

# INFPRV315 Owner's Manual



**Prospec Electronics**  
Sound Systems For The Outdoor Enthusiast



This product is serviced exclusively by Prospec Electronics Inc. and must be returned to Prospec for in and out of warranty repairs. It can not be serviced under warranty by other Infiniti service centers.

For service contact us :  
3325 South Morgans Point Road Mt Pleasant SC 29466

Tel 843-849-9037

Or visit: [www.prospecelectronics.com](http://www.prospecelectronics.com)

\*This stereo should not be washed with a pressure washer neither should it be washed with chemicals. A wet sponge or damp cloth will suffice.\*



**Prospec Electronics**  
Sound Systems For The Outdoor Enthusiast

3325 South Morgans Point Rd. | Mt. Pleasant, SC 29466

P: 843-849-9037 | [www.prospecelectronics.com](http://www.prospecelectronics.com)



## Installation Instructions

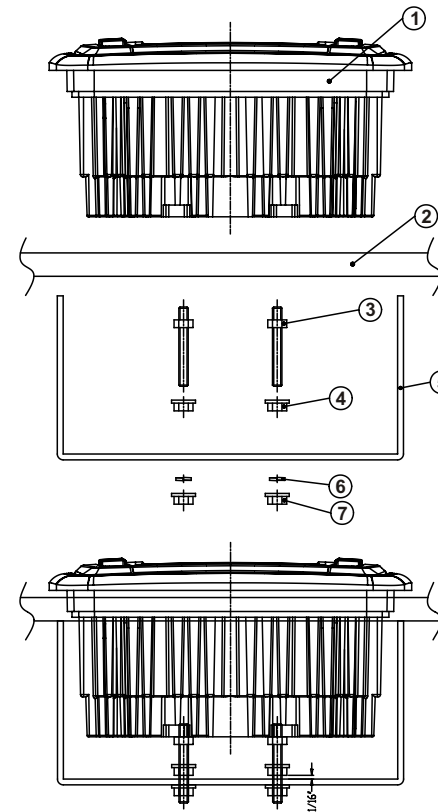

NO.	PART DESCRIPTION
1	RADIO
2	MOUNTING PLATE
3	MOUNTING STUDS
4	JAMB NUTS
5	MOUNTING BRACKET
6	SPRING WASHER
7	OUTER NUTS

### Instructions:

1. Install jamb nuts (4) loosely on mounting studs (3), so they will not touch mounting brackets (5) when installed.
2. Slip mounting bracket (5) on and make flush with mounting surface (2).  
DO NOT TIGHTEN
3. Snug spring washer (6) and outer nuts (7) against mounting plate (2).  
DO NOT TIGHTEN
4. Position jamb nuts approximately 1/16" from mounting bracket.
5. Tighten outer nuts completely.

## Troubleshooting

\*Note: In many respects, a stereo acts much like a computer and occasionally requires a reboot. In the unlikely event of product malfunction, a reset can usually fix the issue. For software reset operation, please refer to page 8.

Issue	Cause	Solution
No power	<ol style="list-style-type: none"> <li>1. Incorrect wiring</li> <li>2. Fuse is blown</li> <li>3. Low battery voltage</li> </ol>	<ol style="list-style-type: none"> <li>1. Double check wiring</li> <li>2. Replace fuse</li> <li>3. Check voltage of vehicle battery with multimeter. Voltage must be at least 11V.</li> </ol>
No Sound	<ol style="list-style-type: none"> <li>1. Speaker connection came loose</li> <li>2. Bad speaker</li> <li>3. Output blown</li> <li>4. Volume too low on media device</li> </ol>	<ol style="list-style-type: none"> <li>1. Double check connections.</li> <li>2. Replace bad speaker with known good speaker and connect.</li> <li>3. Send unit in for repair.</li> <li>4. Increase volume of media device</li> </ol>
No Reception	<ol style="list-style-type: none"> <li>1. Antenna not firmly seated in socket</li> </ol>	<ol style="list-style-type: none"> <li>1. Insert firmly</li> </ol>
USB stick not reading	<ol style="list-style-type: none"> <li>1. File must be a mp3 or wma file</li> </ol>	<ol style="list-style-type: none"> <li>1. Convert format to mp3 or mwa.</li> </ol>
While in Bluetooth mode:		
No Connection	<ol style="list-style-type: none"> <li>1. You are not connect to the "PRV" address on your portable media device.</li> <li>2. Out of range</li> <li>3. The connection is already in use.</li> </ol>	<ol style="list-style-type: none"> <li>1. Choose "PRV"</li> <li>2. Bring portable media device closer to the receiver. Device needs to be within 30'.</li> <li>3. Ask the person who first paired to drop out.</li> </ol>











## Table of Contents

Table of Contents -----	1
Product Description -----	2
Installation -----	3
Wiring Configuration -----	3
General Function of Buttons -----	4
Generation Operations -----	5
Radio Section Operation -----	9
Bluetooth Section Operation -----	11
USB Section Operation -----	13
AUX Section Operation -----	15
Troubleshooting -----	16
Installation Instructions -----	17

## Product Description

This Infinity PRV315 incorporates a 3.5" TFT color screen, ready to complement your day whether you are on the water, motorcycle, UTV trail, or farm. Following the same footprint as the popular INFPRV250, this stereo is synonymous with excellence.

The INFPRV315 incorporates the following features:

-  AM/FM/WB
-  Bluetooth Audio Streaming with ID tagging
-  USB input and control-for USB drives only
-  Auxiliary input
-  3.5" color TFT screen / Waterproof faceplate
-  45W x 4 amplifier
-  Wired remote option
-  U.S. and European tuning
-  Charging through USB
-  3 pair of RCA output including Subwoofer

The Infinity brand is part of Harman International Industries. In 1958, Harman Kardon developed the world's first stereo receiver and we are proud to bring you the world's first Infinity marine color screen receiver!

## AUX Section Operation

### 1. To Select USB mode

- There are two ways to select AUX mode.
- By repeat press SOURCE button.
  - By press TUNE UP/DN button at Main Source screen and press SEL knob when AUX Icon selected. (Note: highlight movement indicated by the icon background change to two tone orange).



The use of auxiliary mode allows you to play the portable music device through the headphone jack.

Note: An additional accessory/adaptor must be purchased in order for this to happen. Prospec's part, SEAMINI2 or SEAUSBMINI36 fulfills this option.

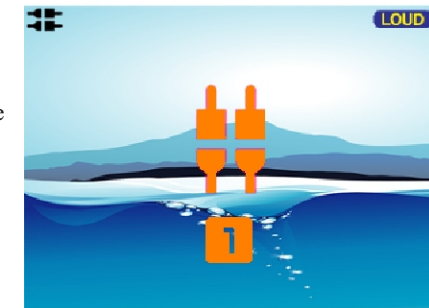

## USB Section Operation



### 5. Scan Play

While USB playing, simply press SEL knob to activate navigation, it will highlight at SCAN, now repeat press SEL to toggle select Track Scan, Directory Scan, or SCAN OFF. (Note: The play mode icon would change simultaneously.)

- SCN** Refers to play the first 10s of all the tracks in the USB device.
- D.SCN** Refers to play the first 10s of all the tracks in current Directory.
-  Refers to play all the tracks in normal sequence.



### 6. Repeat play

While USB playing, simply press SEL knob to activate navigation, then press TUNE Down button to move highlight to RPT, repeat press SEL to toggle select Track Repeat, Directory Repeat, or RPT OFF. (Note: The play mode icon would change simultaneously.)

-  Refers to play current track repeatedly.
-  Refers to play the tracks in current Directory repeatedly.
-  Refers to play all the tracks in normal sequence.

### 7. Random play

While USB playing, simply press SEL knob to activate navigation, then press TUNE Down button to move highlight to RDM, repeat press SEL to toggle select Track Random, Directory Random, or RDM OFF. (Note: The play mode icon would change simultaneously.)

-  Refers to play all the tracks in a random sequence.
-  Refers to play the tracks in current Directory in a random sequence.
-  Refers to play all the tracks in normal sequence.

### 8. F.LIST (Folder / File Search)

While USB playing, simply press LIST button to enter search mode, then press TUNE Up or Down button to choose desired Folder, press SEL to display sub-directory or files inside, press TUNE Up or Down button to choose desired file and press SEL button to play it.



## Installation

A mounting gasket has been added inside the package for convenience. Trace along the outside edge of the gasket thus revealing your cutout.

### Mounting Illustration

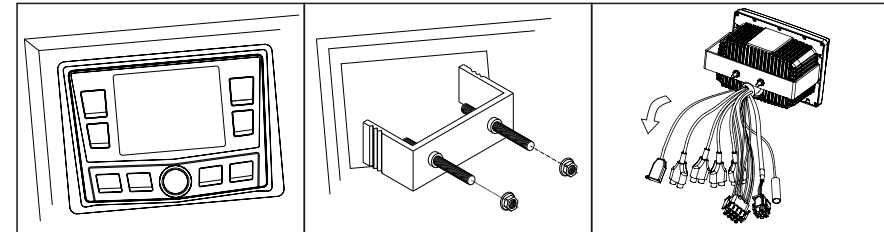

1. Avoid installing stereo below cupholders! Make sure mounting substrate is flat to avoid flexing of the plastic.
2. Use the back bracket and studs to affix the unit. Install the U bracket behind the unit, using two nuts per bolt for ultra hold.
3. To avoid possible water ingress into wire harness area, route the harness in the downward direction as shown above.

## Wire Configuration

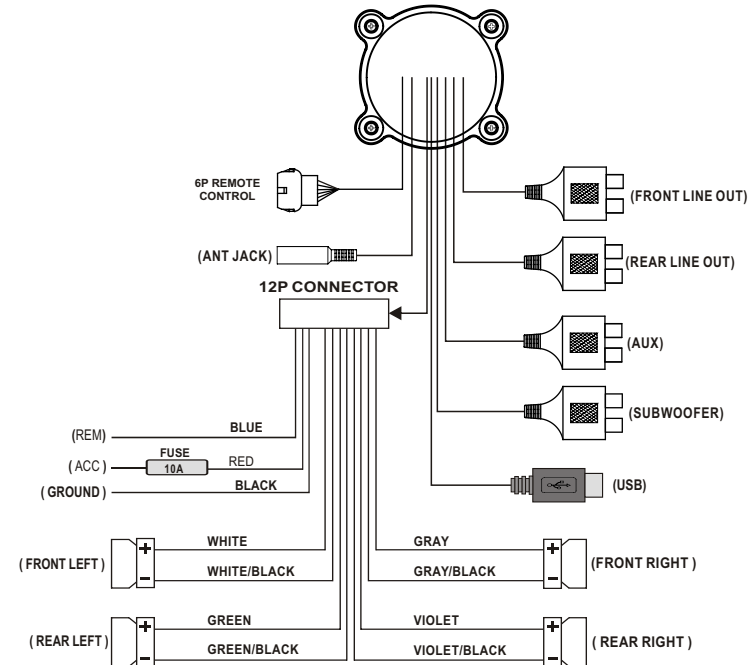

**NOTE:** When wiring, the red lead is recommended to be wired to ACC/ignition power lead.

## General Function of Buttons

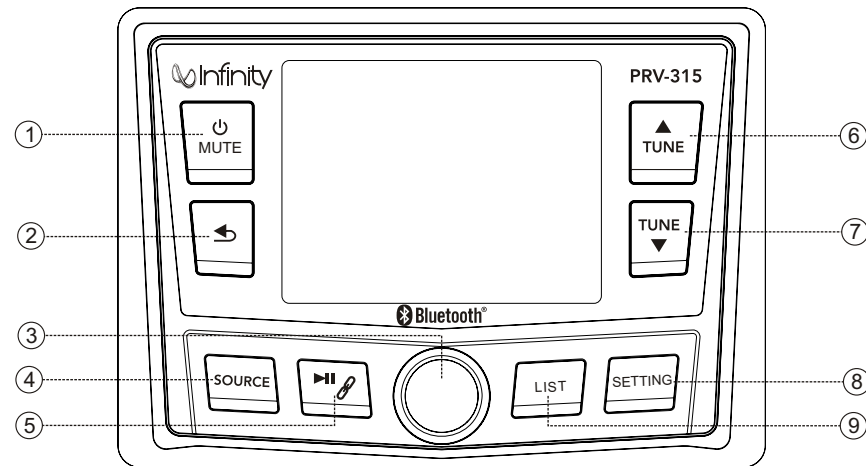

### 1. POWER, MUTE button

- With unit off, press to power the unit on.
- With the unit on, press to MUTE sound output, press again to resume sound output.
- With the unit on, press and hold for over 2s to power the unit off.

### 2. RETURN button

- In any status, press it to back to previous display; press and hold it for 2s to navigate to home display.

### 3. VOLUME knob, SEL button

- Turn the knob right or left to adjust volume level.
- Press it to confirm selection.

### 4. SOURCE button

- Repeat press it to select source in following sequence:  
FM --> AM --> WB --> USB --> AUX --> BT MUSIC.

### 5. PAUSE button, LINK button

- In USB, BT MUSIC playing status, press it to pause playback, press again to resume playback.
- In BT Music mode, it works BT pairing, connect and disconnect. (See Bluetooth section operation in page for details.)

### 6. Tune Up button

- In playing status, press to select the next station or track.
- In navigation mode, press to move highlight upward/over.

### 7. Tune Down button

- In playing status, press to select the previous station or track.
- In navigation mode, press to move highlight downward/over.

### 8. SETTING button

- In any status, press to display Settings. (See page for details operation.)

### 9. LIST button

- In FM, AM, WB mode, press to display Global Preset List.
- In USB mode, press to display Fold/File List.

## USB Section Operation

### 1. To Select USB mode

There are two ways to select USB mode.

- By repeat press SOURCE button.
  - By press TUNE UP/DN button at Main Source screen and press SEL knob when USB Icon selected.
- (Note: highlight movement indicated by the icon background change to two tone orange.)

Note: This input is designed to read and play USB drives (mp3 and wam files), not media/phones.

You can charge most phones through the USB input. Music, however, needs to be played back by using either BT or Aux input.



### 2. USB Screen Description

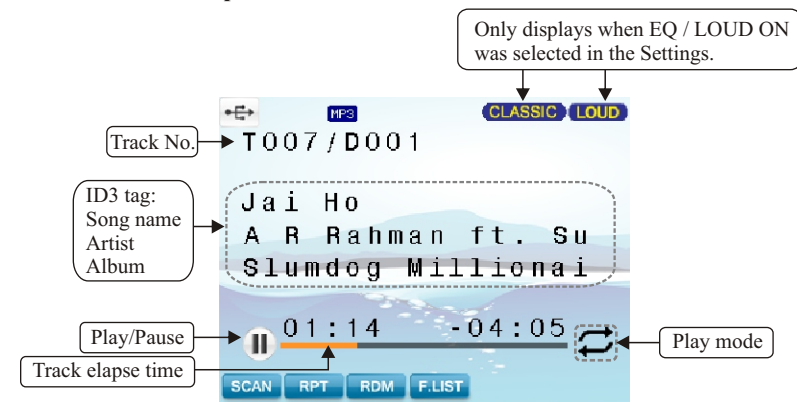

SCAN: Intro Scan play (Track / Directory Scan play)

RPT: Repeat play (Track / Directory Repeat play)

RDM: Random play (Track / Directory Random play)

F.List: To display the Directory / File List

### 3. Play/Pause Play

While USB is playing, press the PAUSE button to pause the playback, and press again to resume playback.

Note: refers to PLAY; refers to PAUSE.

### 4. Track Up/Down

While USB playing, simply press TUNE Up or Down button to select the next or previous track. To fast forward or rewind, press and hold TUNE button.

## Bluetooth Section Operation

### 5. Track Up/Down

While BT Music is playing, press TUNE Up or Down button to select the next or previous track.

### 6. Disconnect

In BT Music playing mode, in order to disconnect the BT device

- Press and hold LINK button for more than 2 seconds.
- Or press SEL knob to activate bottom navigation, it will highlight at DISCONN, press SEL again to disconnect the BT connection.

Note: When your BT device battery is at low charge, the Bluetooth connection may occasionally be lost. To maintain good connectivity ensure that your BT device battery is adequately charged.

### 7. Connect

With BT device paired OK, but disconnected, if you want to re-establish the BT connection

- Press and hold LINK button for more than 2 seconds.
- Or press SEL knob to activate bottom navigation, it will highlight at CONN, press SEL again to connect the BT device.

Note: With the Bluetooth connection disconnected, once you power on the unit next time, it will establish the Bluetooth connection automatically.

## General Operations

### 1. POWER / MUTE button

With the unit powered off, press it button to turn the unit on.

With the unit on, press it to MUTE sound output, press again to resume sound output, and press and hold it for over 2s to power the unit off.

Once the unit powered on, the introductory home screen appears for 4 seconds, then switches to the last played mode before power off occurred.



Introductory home screen



MUTE icon display

### 2. RETURN button

In Source playing status, press and hold it for more than 3s to display the Main Screen.

At Main Screen, press TUNE UP/DN button to move highlight among Sources and press SEL knob at desired Source.

In Sub-feature selection status, press it to return to previous screen.

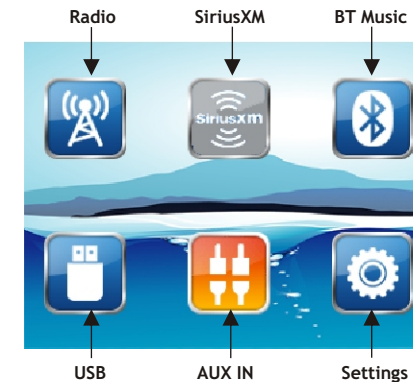

#### NOTE:

1. Icon background changes to two toned burnt orange when selected. For example, AUX mode is the selected mode in the picture.
2. SiriusXM is not available on PRV315, so it could not be selected.

## General Operations

### 3. SOURCE button

Repeat press it to change source in following sequence:

FM --> AM --> WB --> USB --> BT MUSIC --> AUX --> FM.

(Note: Without USB or BT device connected, the corresponding source will not display while pushing Source button. Besides Source can also be selected in Main Source screen.)

### 4. SETTING button

In any status, press it to display settings. Then press TUNE UP/DN button to select the sub-features that desired to adjust, then turn VOL knob to adjust it.

#### 4-1. Bass Control

In Settings screen, press TUNE UP/DN button to select Bass, then turn VOL knob to adjust the level.

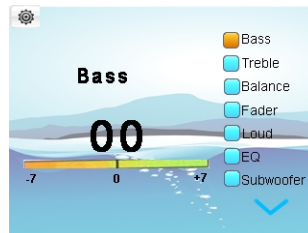

#### 4-2. Treble Control

In Settings screen, press TUNE UP/DN button to select Treble, then turn VOL knob to adjust the level.



#### 4-3. Balance Control

In Settings screen, press TUNE UP/DN button to select Balance, then turn VOL knob to adjust the level.

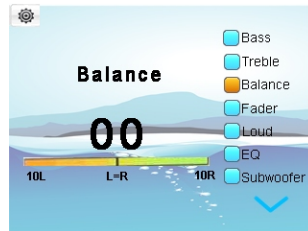

#### 4-4. Fader Control

In Settings screen, press TUNE UP/DN button to select Fader, then turn VOL knob to adjust the level.

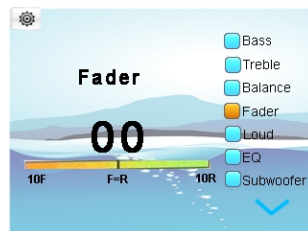

## Bluetooth Section Operation

### 1. To Select Bluetooth mode

There are two ways to select Bluetooth mode.

- By repeat press SOURCE button.
- By press TUNE UP/DN button at Main Source screen and press SEL knob when Bluetooth Icon selected. (Note: highlight movement indicated by the icon background change to two tone orange.)



### 2. Bluetooth Screen Description

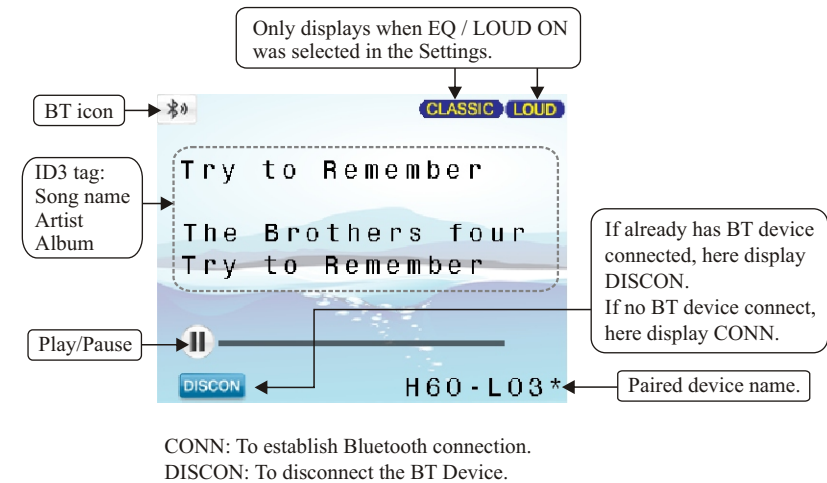

### 3. Pair BT Device

If there is no BT device paired, go to settings on the BT device and turn the Bluetooth option ON. Pick "PRV" option on your Bluetooth enabled device. (if you are prompted for a password, the code entered will be "1234".)

### 4. Play/Pause Play

Once the BT device connection is successful, music will begin to play.

Note: For some Bluetooth enabled phones, you might activate play from your phone first. It depends on the phone itself.

While BT Music playing, press the PAUSE button to pause the playback, and press it again to resume playback.

Note: refers to PLAY; refers to PAUSE.





## Radio Section Operation

### 6. Station Save

In Radio play mode, manually or auto tune to a station, then press SEL knob to activate bottom navigation at SAVE icon and press SEL again. It will display the Save Global Preset List screen, press TUNE UP/DN button to select a preset No. and press SEL to save the station into the selected Preset No. in the List. The Preset number will display once the station is saved. The unit will go back to previous display if no operation in 5s.

### 7. To Recall Preset Station

In Radio play mode, press LIST button to display the Global Preset List, then press TUNE UP/DN button to select a preset station and press SEL knob to confirmation selection.

It will let you preview the selected station for 10s before it reverts back to Radio screen.

During this time, you can select another station with TUNE UP/DN button.

Global Preset List			
01	CH 056	10	CH 025
02	90.10 MHz	11	107.90 MHz
03	98.10 MHz	12	87.50 MHz
04	106.10 MHz	13	603 KHz
05	CH 146	14	CH 008
06	87.50 MHz	15	CH 002
07	630 MHz	16	106.10 MHz
08	CH 015	17	107.90 MHz
09	1400 KHz	18	87.50 MHz

#### NOTE:

1. Receiver can store up to 18 stations.
2. If there is no operation at Global Preset List screen, it will go back to Radio screen by itself after 5s or simply press RETURN button to go back to previous display.



## General Settings

### 4-5. Loud Control

In Settings screen, press TUNE UP/DN button to select Loud, then turn VOL knob to select ON or OFF.

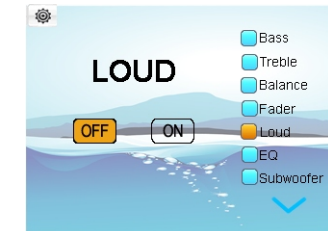

### 4-6. EQ Selection

In Settings screen, press TUNE UP/DN button to select EQ, then turn VOL knob to select Off, Classics, Jazz, Pop or Rock.



### 4-7. Subwoofer Gain Control

At Setting screen, press TUNE UP/DN button to select Subwoofer, then turn VOL knob to adjust the Sub. Gain level.

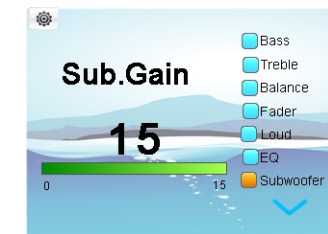

### 4-8. I-Volume Control

At Setting screen, press TUNE UP/DN button to select I-VOL, then turn VOL knob to adjust the level. This feature controls the maximum volume level desired when powered on.

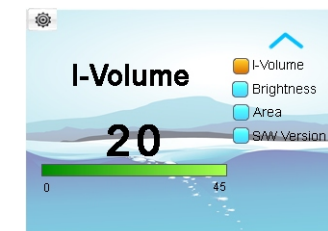

### 4-9. Brightness Adjustment

In Settings screen, press TUNE UP/DN button to select Brightness, then turn VOL knob to adjust Brightness level.





## General Settings

### 4-10. Area Selection

In Settings screen, press TUNE UP/DN button to select AREA, then turn VOL knob to select USA or EUR.



### 4-11. Software Version View, Software Reset

At Setting screen, press TUNE UP/DN button to select S/W Version, then press SEL knob to view the Software Version.



#### Software Reset:

In Software Version display status, press TUNE UP, TUNE DN, and TUNE UP in sequence, then press and hold TUNE DN for 7s to reset the unit.

Note: It will be necessary to re-enter the radio preset memories and other personal settings as these will have been erased when the software was reset. After resetting the unit, ensure all functions are operating correctly.



## Radio Section Operation

### 1. To Select Radio mode

There are two ways to select Radio mode.

- By repeat press SOURCE button.
- By press TUNE UP/DN button at Main Source screen and press SEL knob when Radio Icon selected. (Note: highlight movement indicated by the icon background change to two tone orange.)

### 2. Radio Screen Description

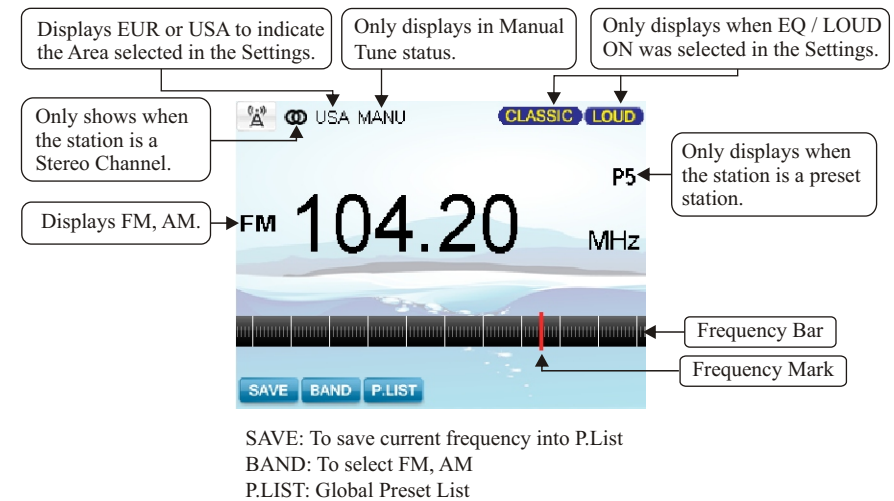

### 3. BAND Selection

There are two ways to select BAND.

- By repeat press SOURCE button.
- In Radio screen, press SEL knob to activate navigation, then press TUNE UP/DN button to move highlight to BAND. Now press SEL repeatedly to toggle between FM, AM or WB band.

### 4. Auto Tuning

In Radio playing mode, press TUNE UP/DN button to activate auto tune. This results in automatically stopping at next station of sufficient signal strength.

### 5. Manual Tuning

In Radio playing mode, long press TUNE UP/DN button for 2s. This will activate manual tune with MANU display on the top area. Then repeatedly press TUNE UP/DN button to tune frequency by steps.

NOTE: Radio will revert back to AUTO tune mode after 5s without operation.

